

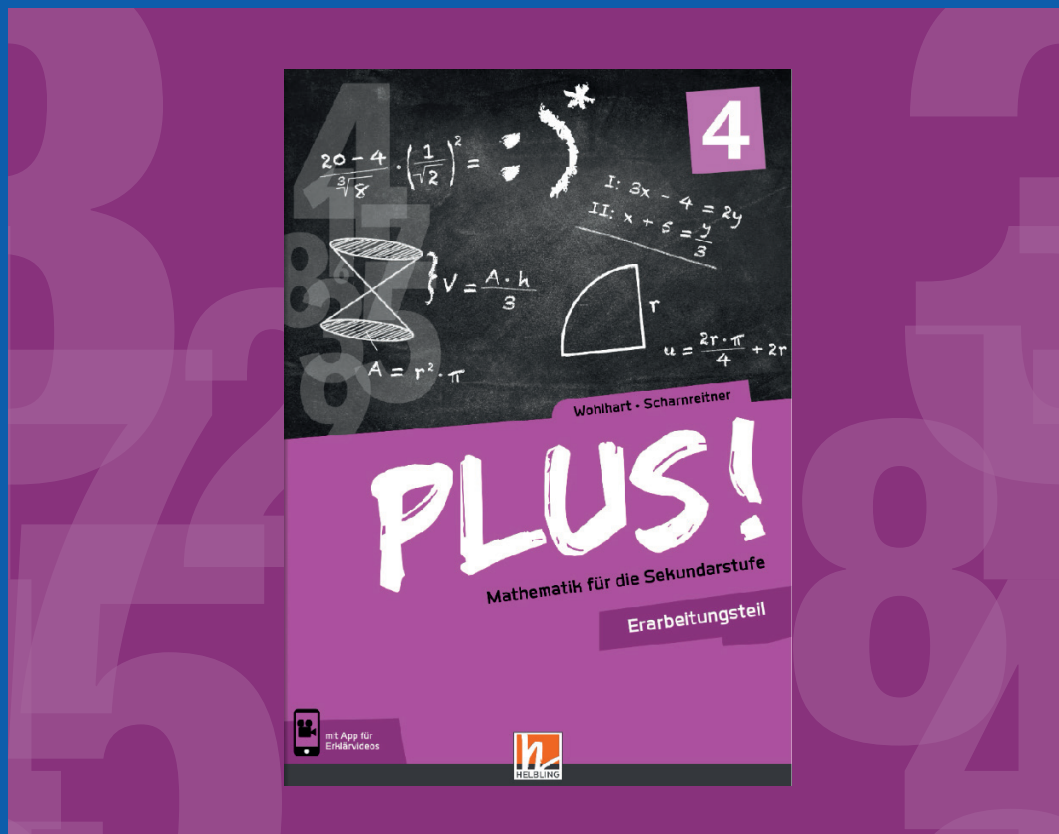

**Vergrößerte und aufbereitete Versionen  
ausgewählter Grafiken aus dem Schulbuch**

# Plus! 4



**Grafiken: Tomáš Batha**

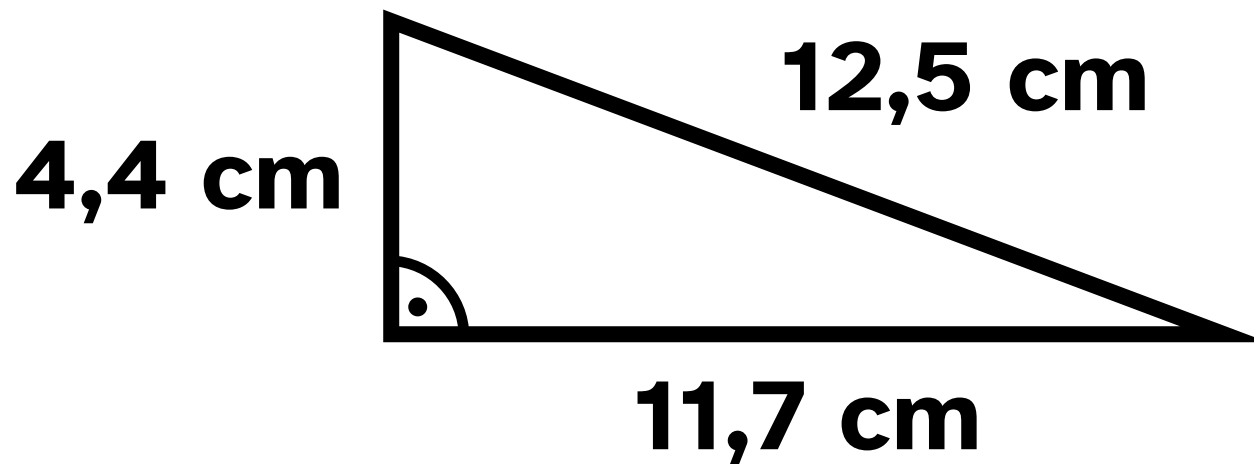
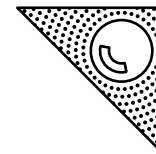

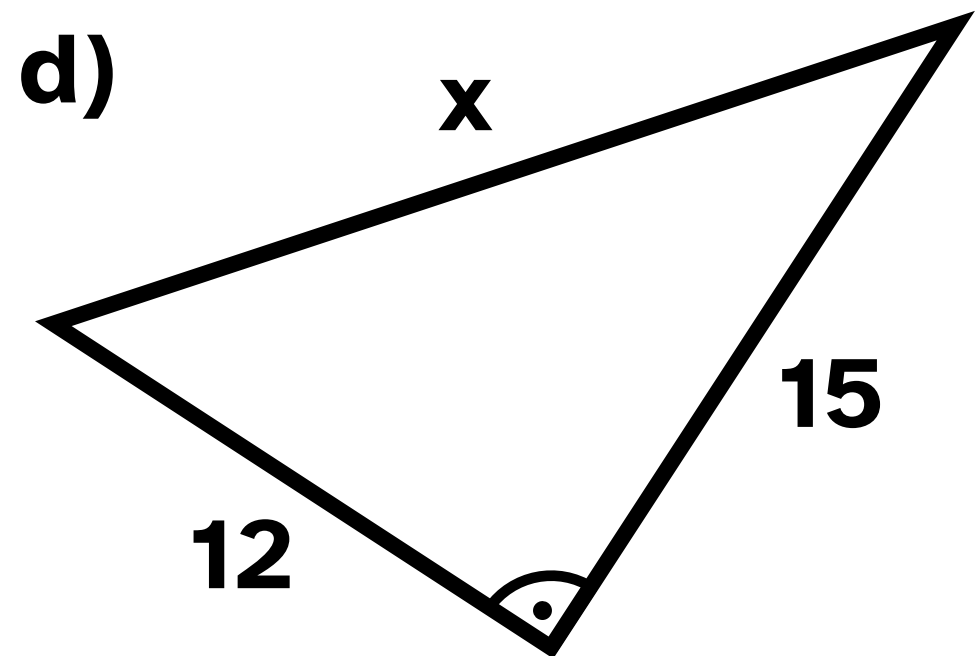
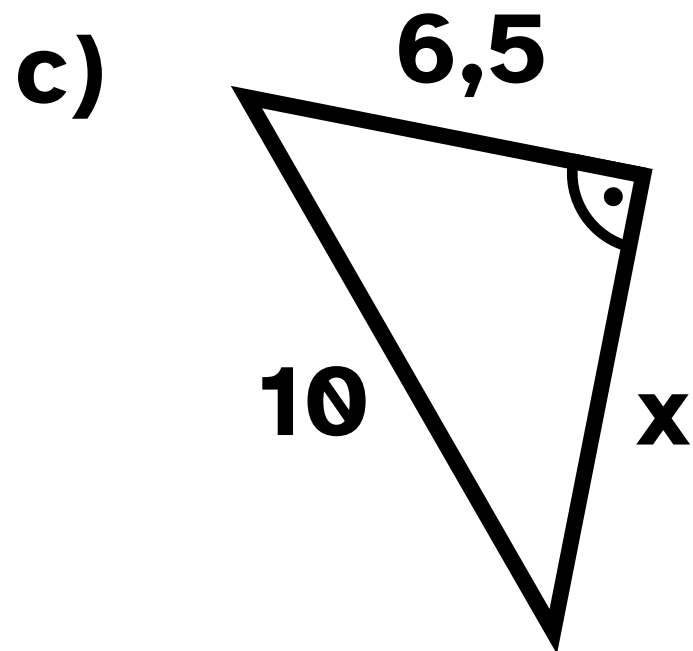
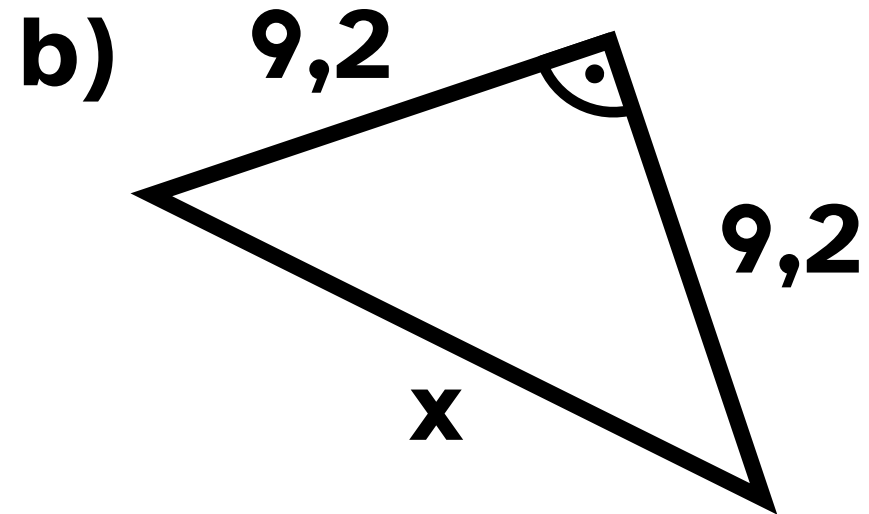
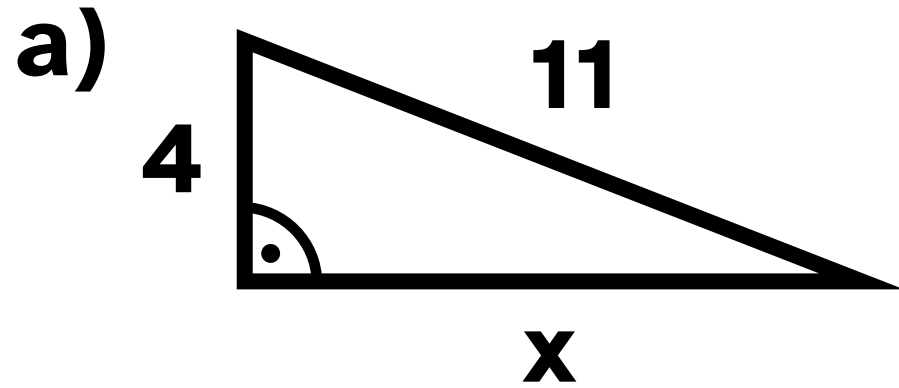
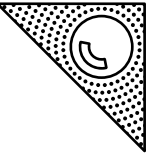

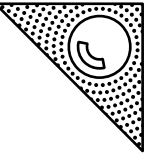

a)

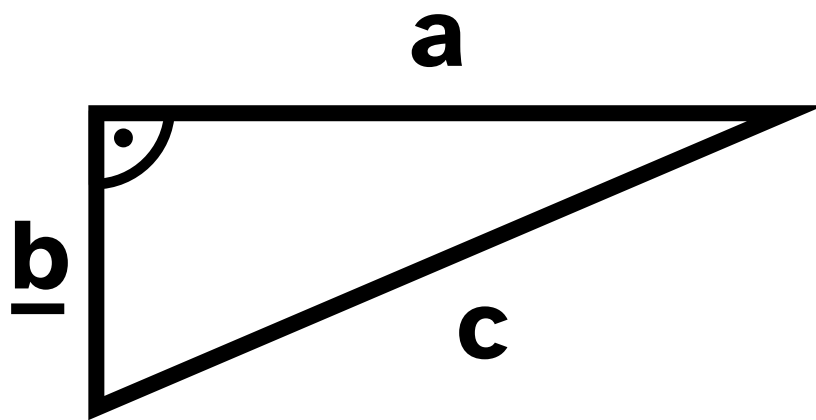

b)

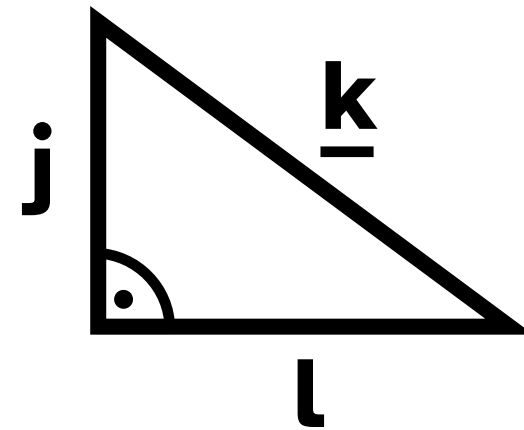

c)

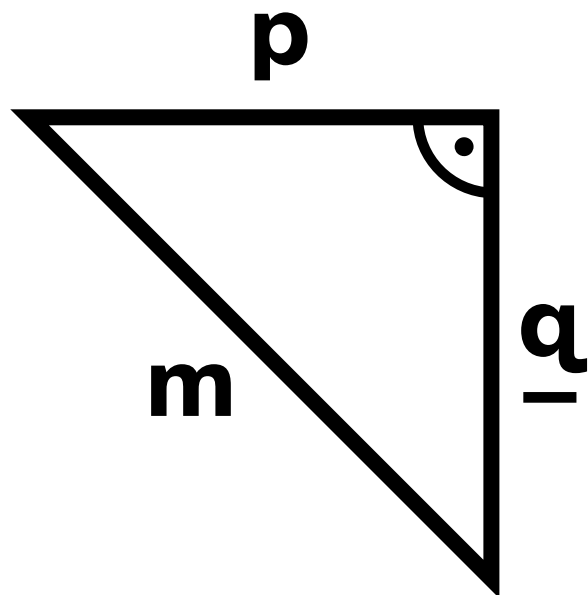

d)

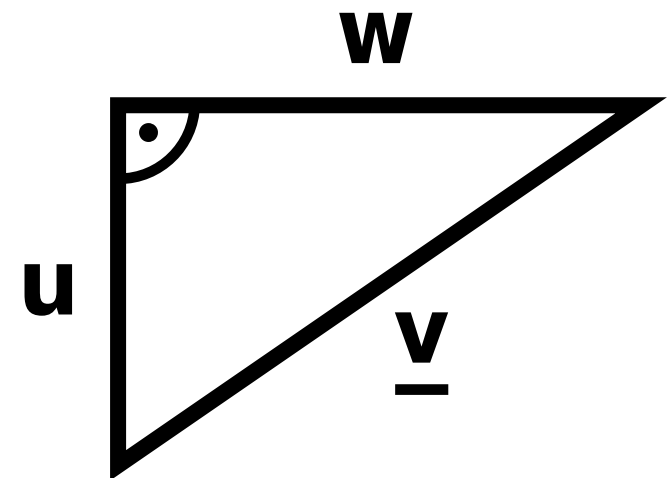

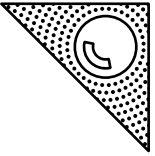

# Rechtwinkliges Dreieck

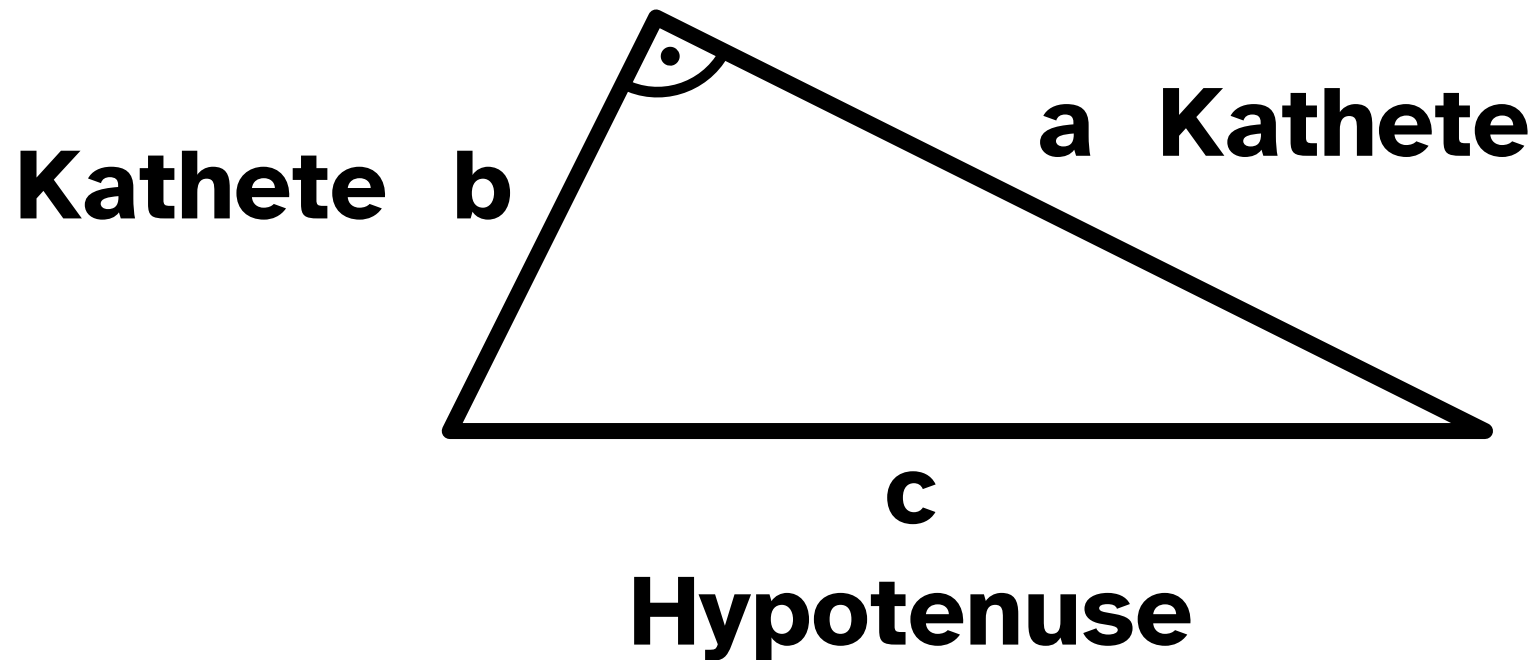

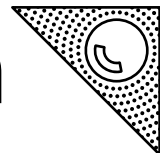

# Satz des Pythagoras

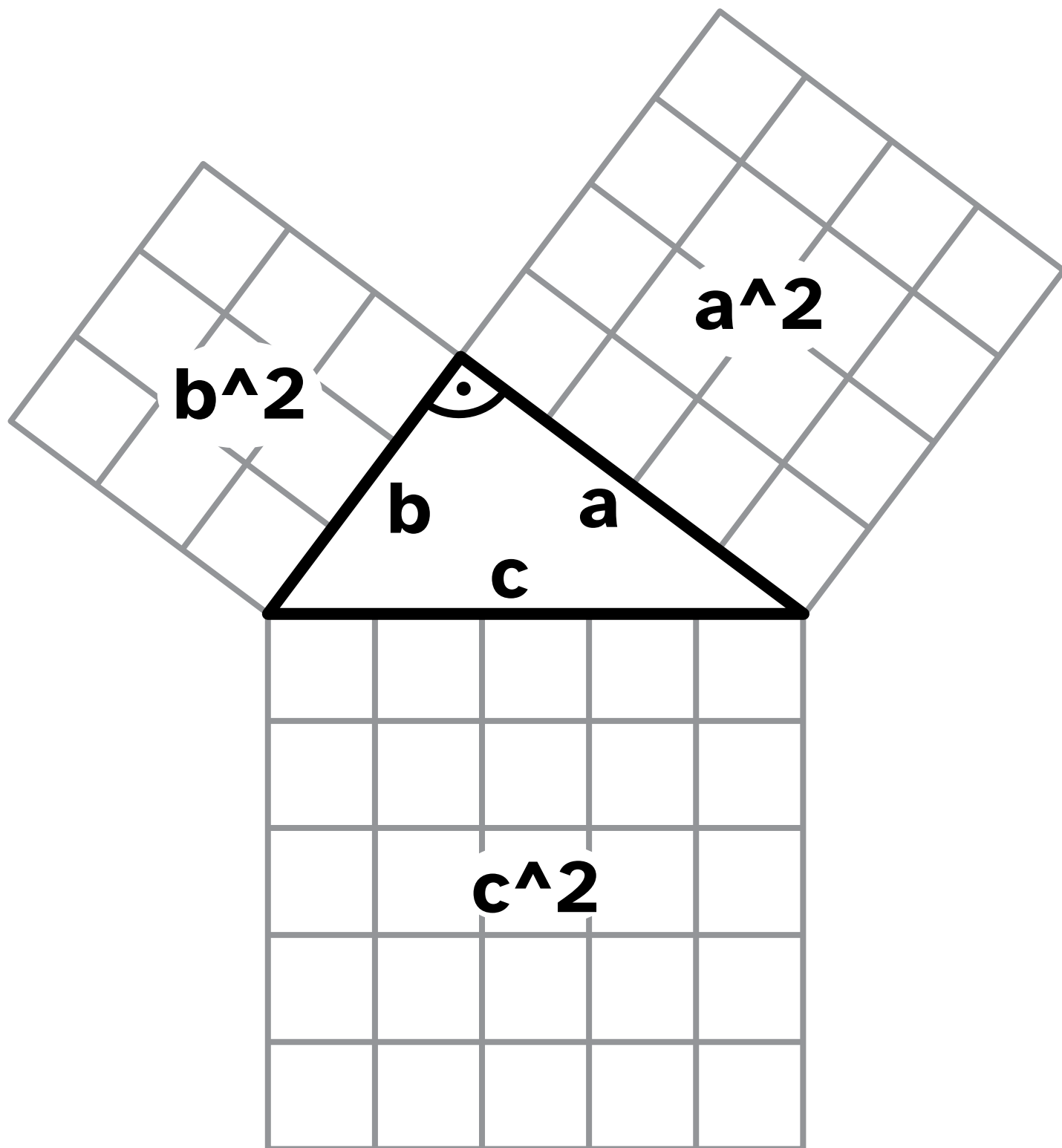

# Plus4

S.24 94, 96

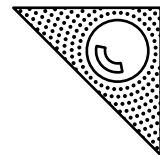

a)

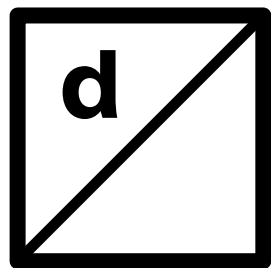

3 m

b)

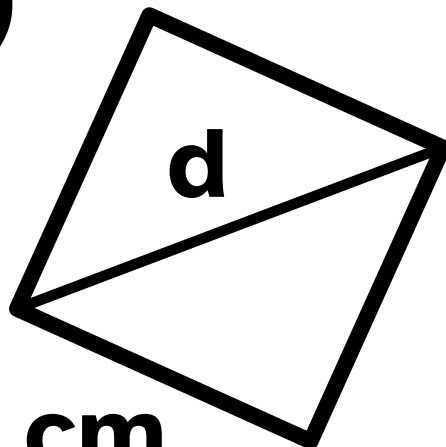

25 cm

c)

4,82 m

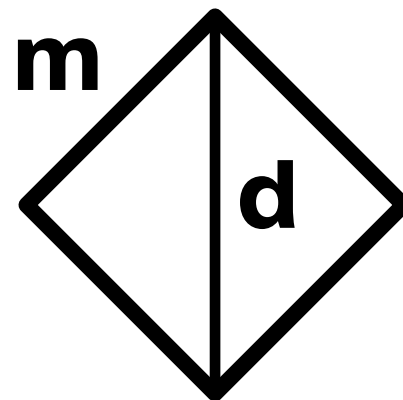

a)

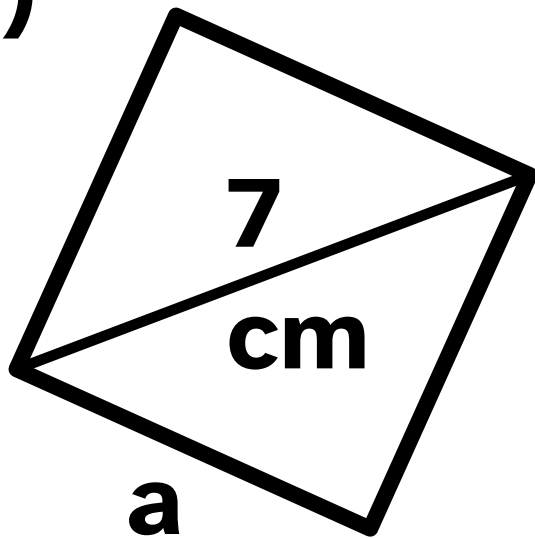

b)

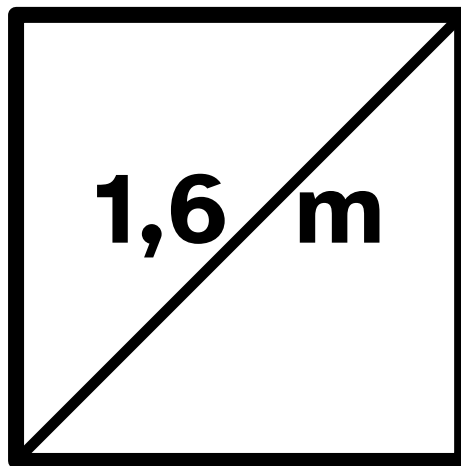

c)

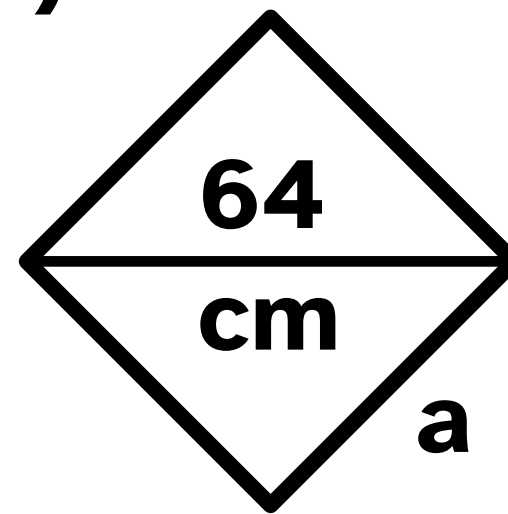

**Plus4**

**S.25 101, 103**

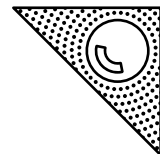

**a)**

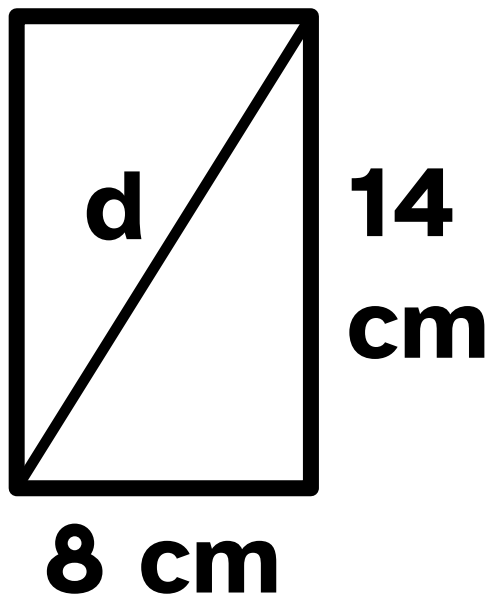

**b)**

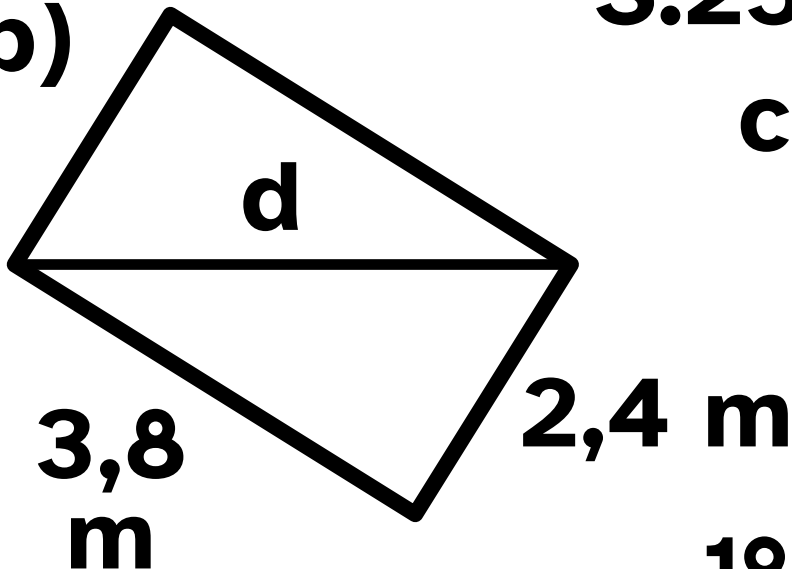

**c)**

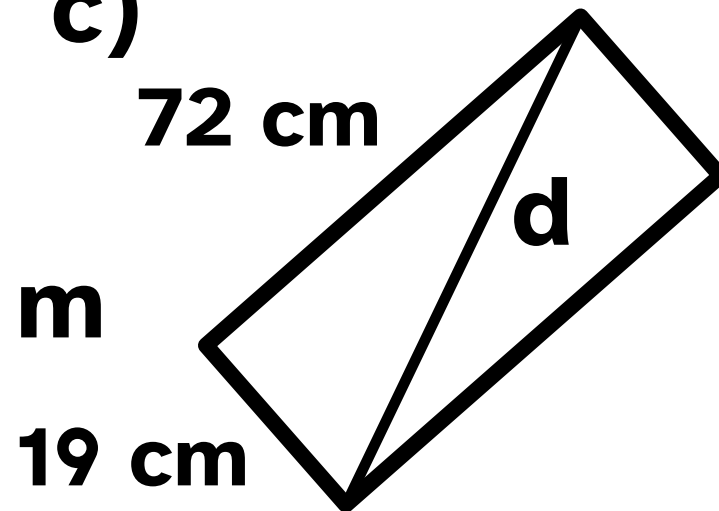

**a)**

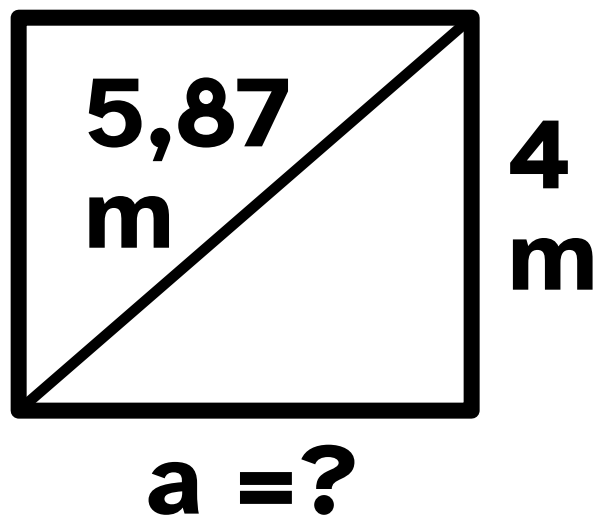

**b)**

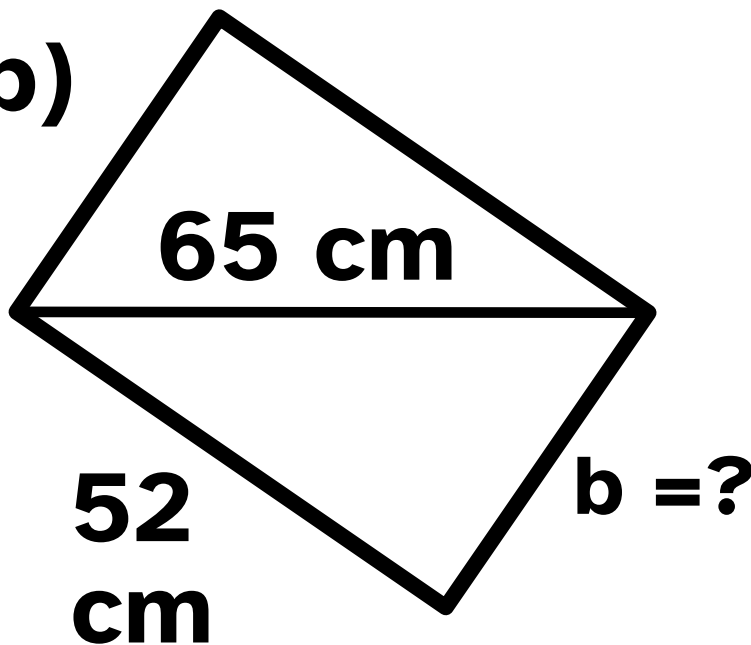

**c)**

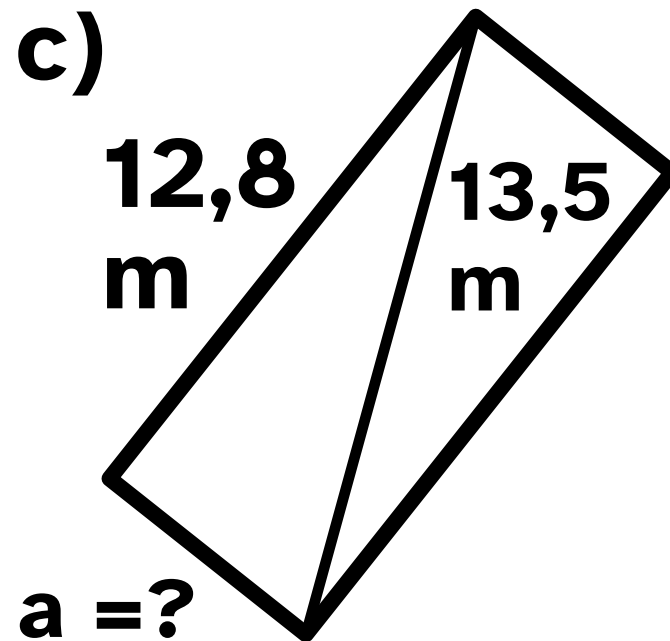



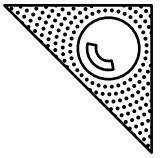

a)

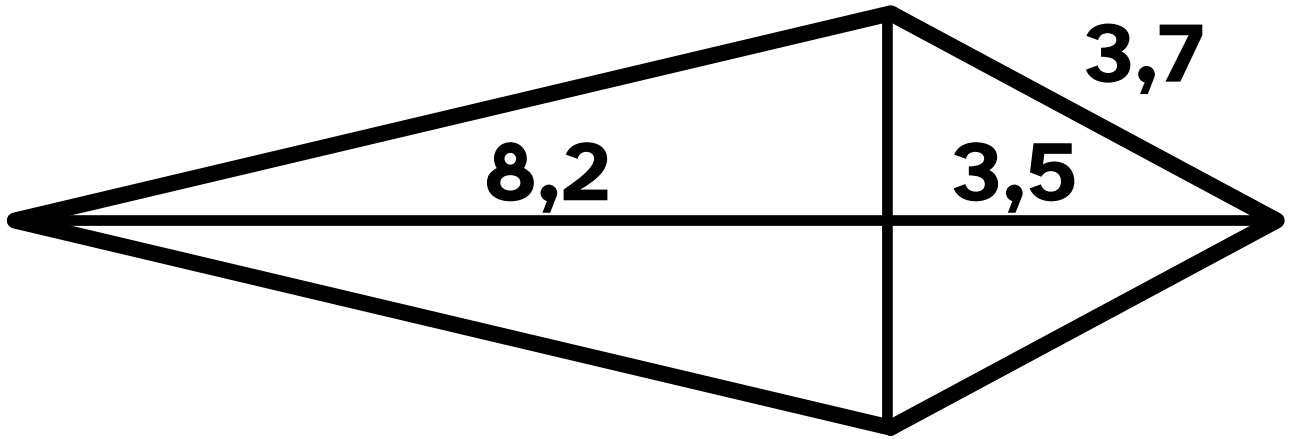

b)

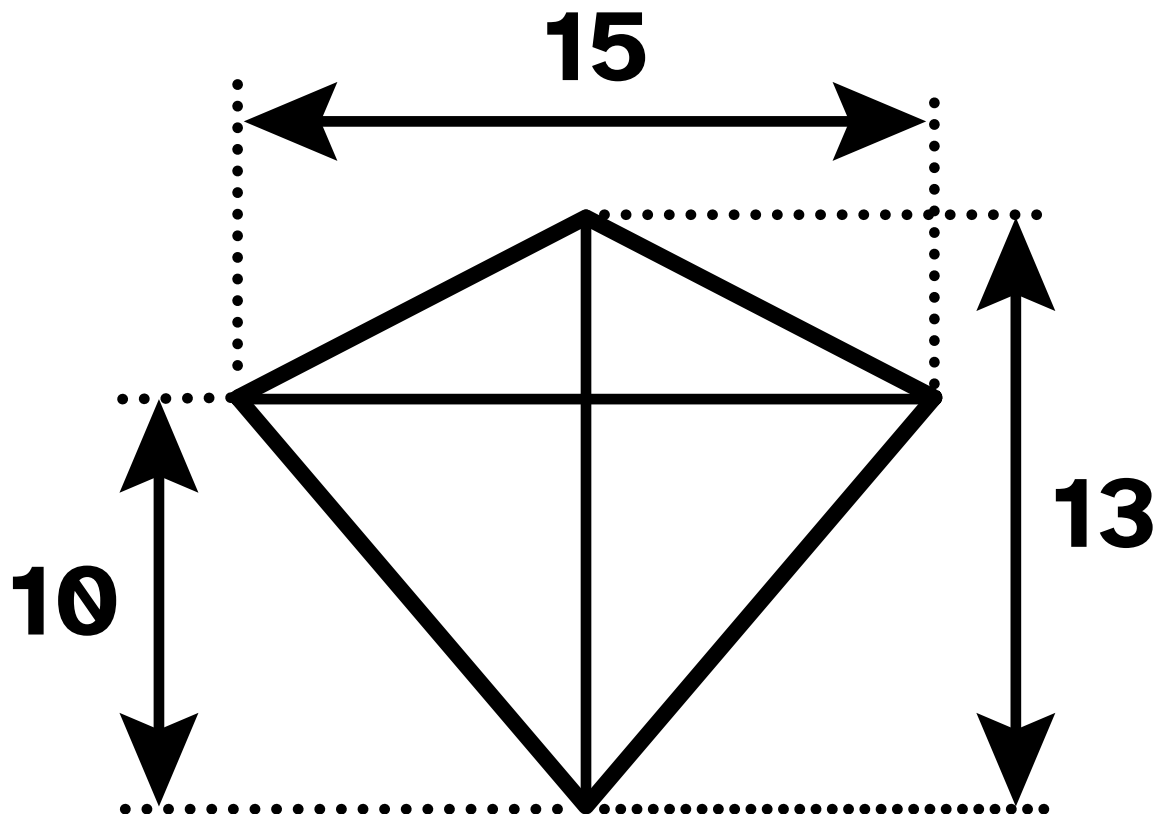

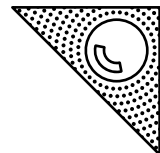

a)

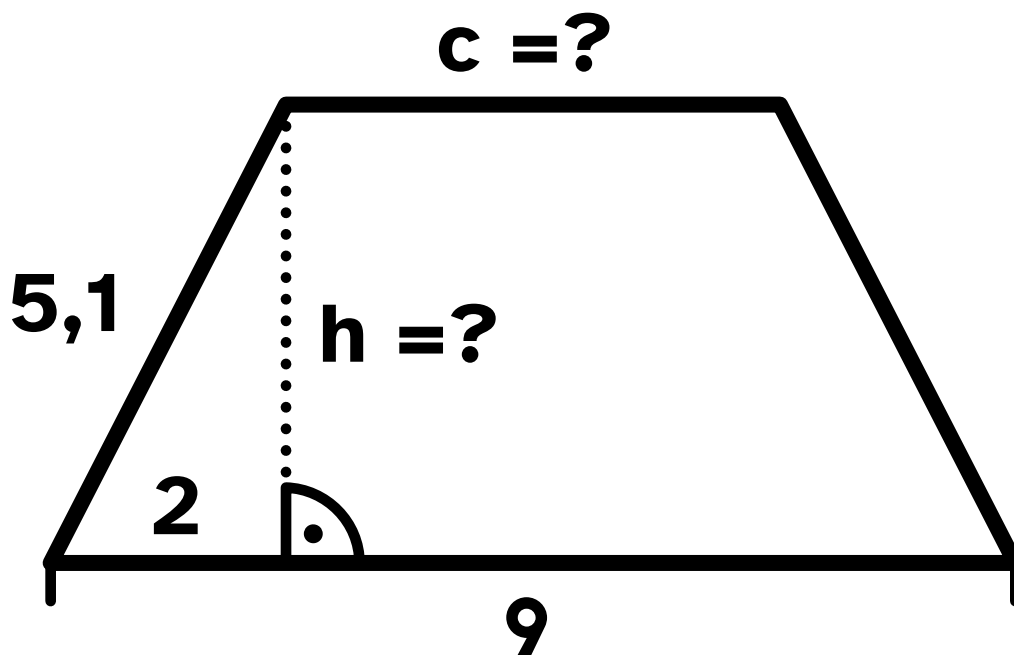

b)

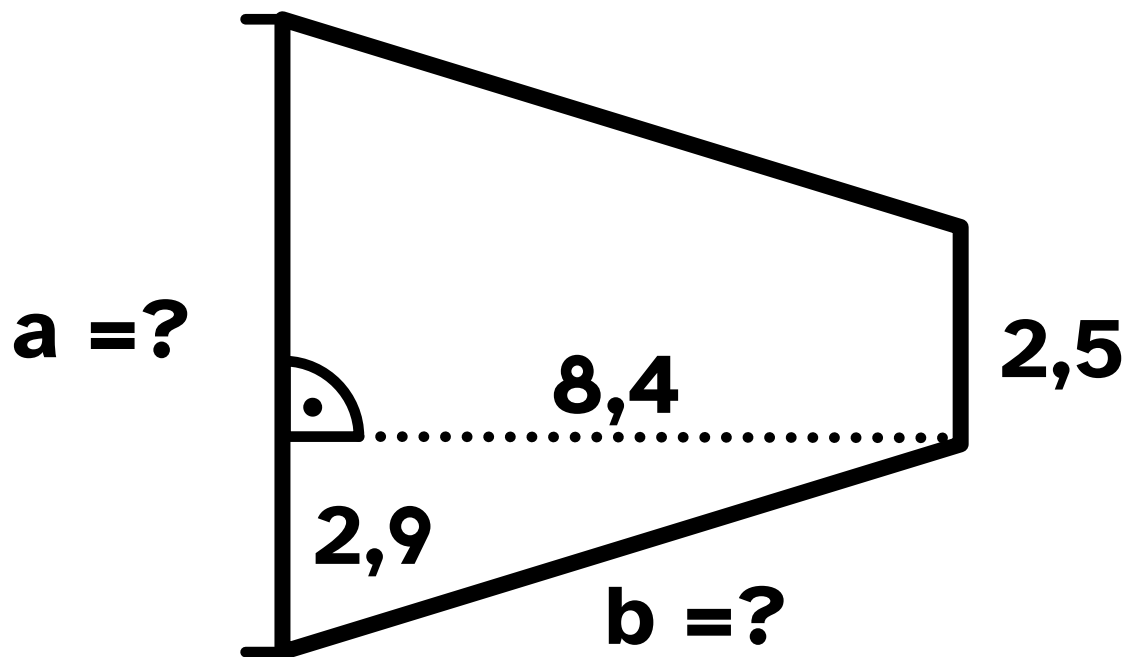

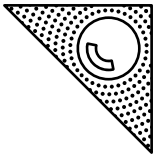

a)

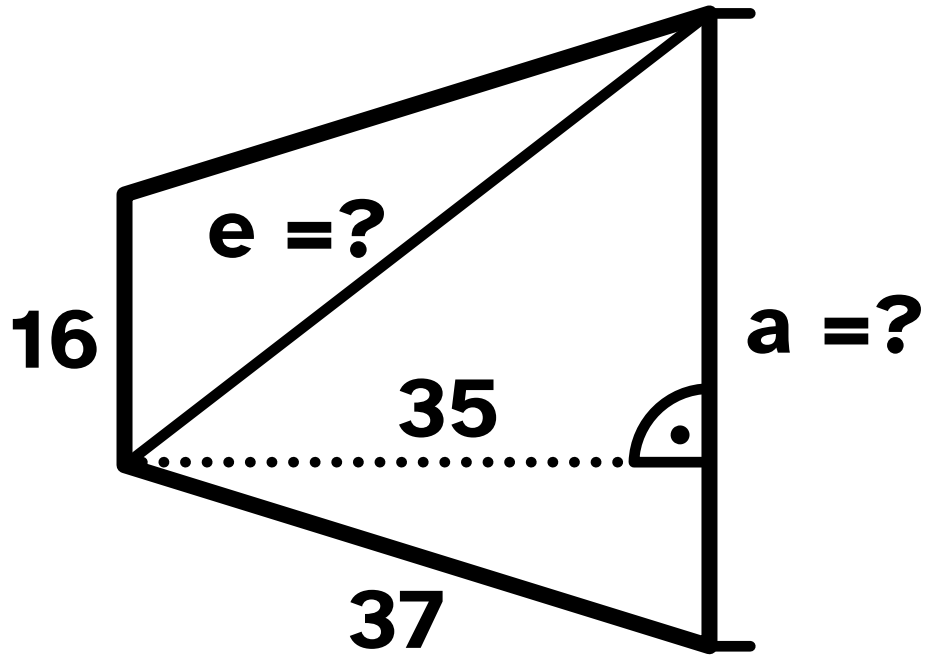

b)

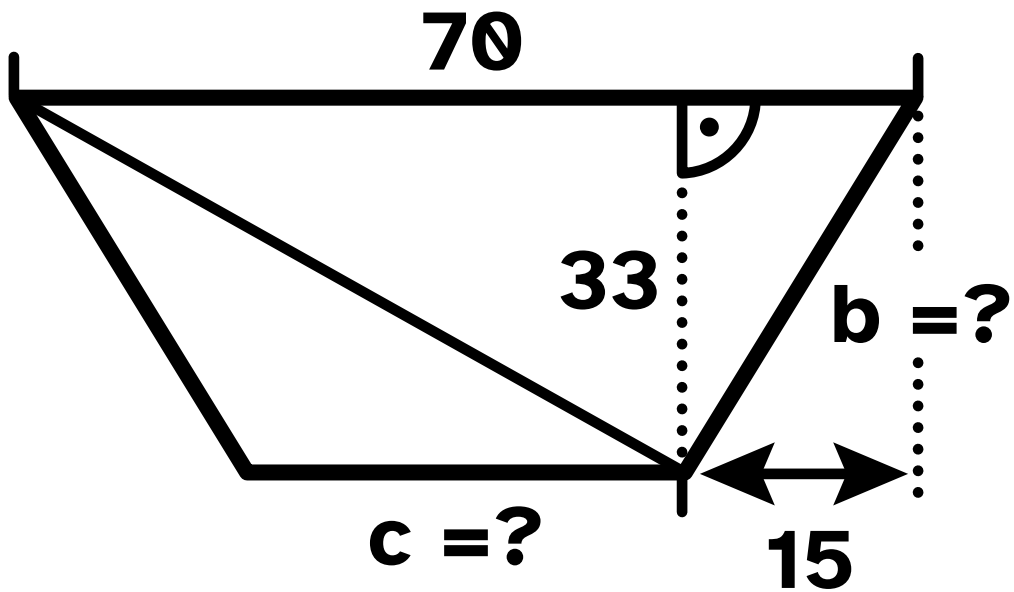

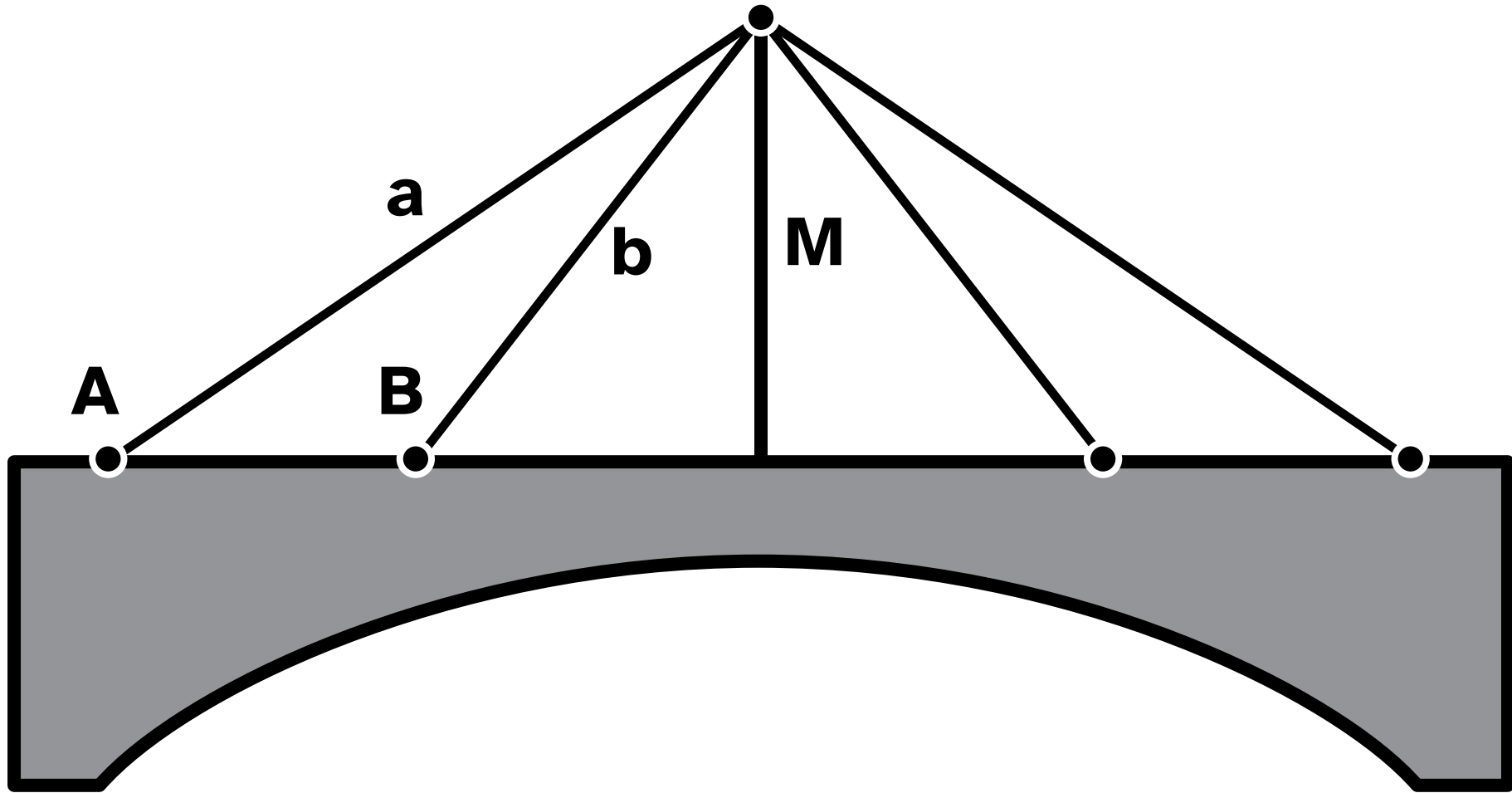
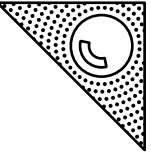

Plus4

S.30 133, 134, 135

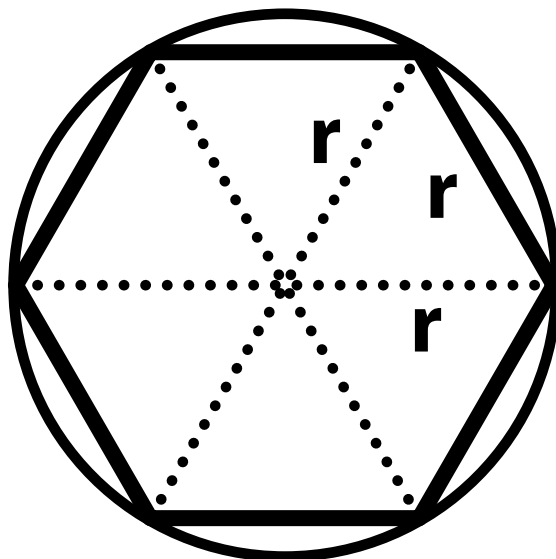
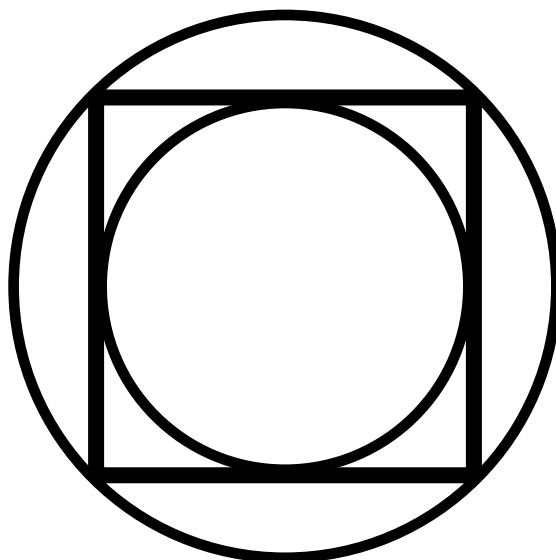
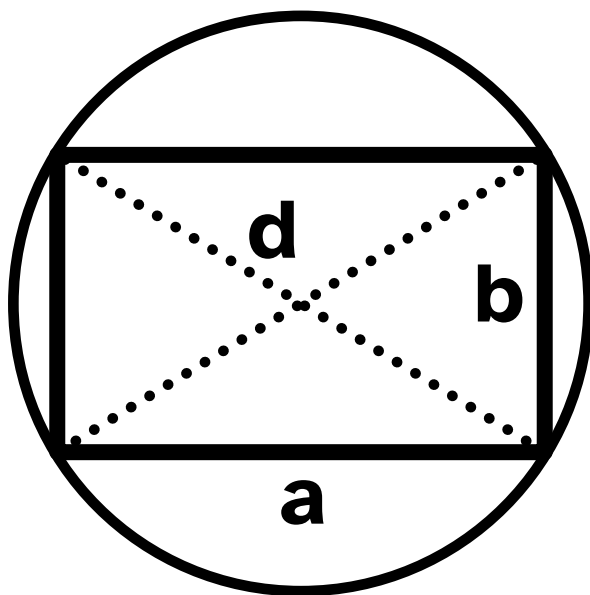
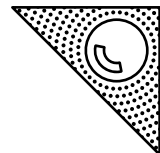

# Plus4

# S.32 137

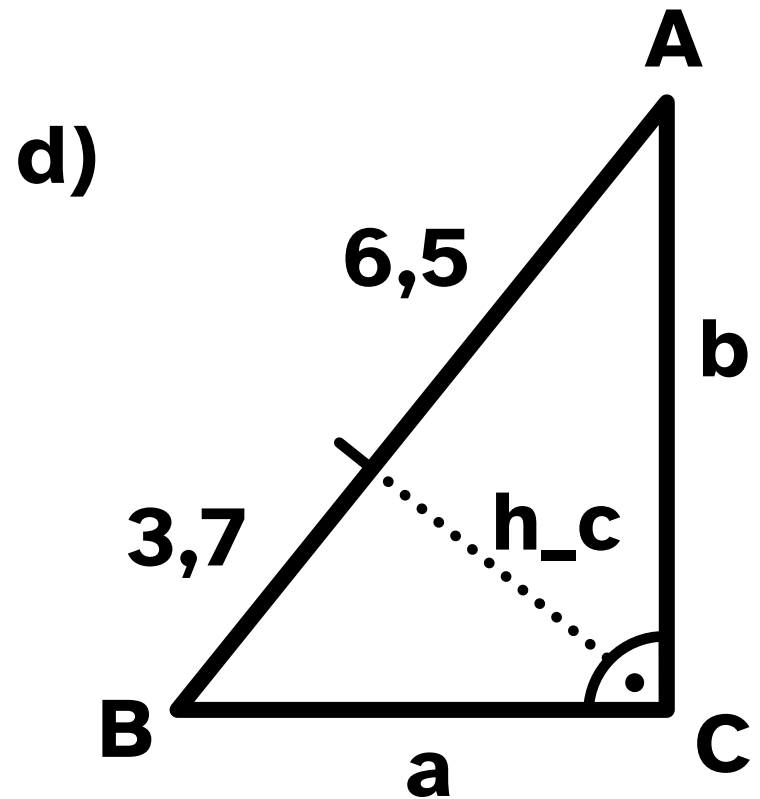
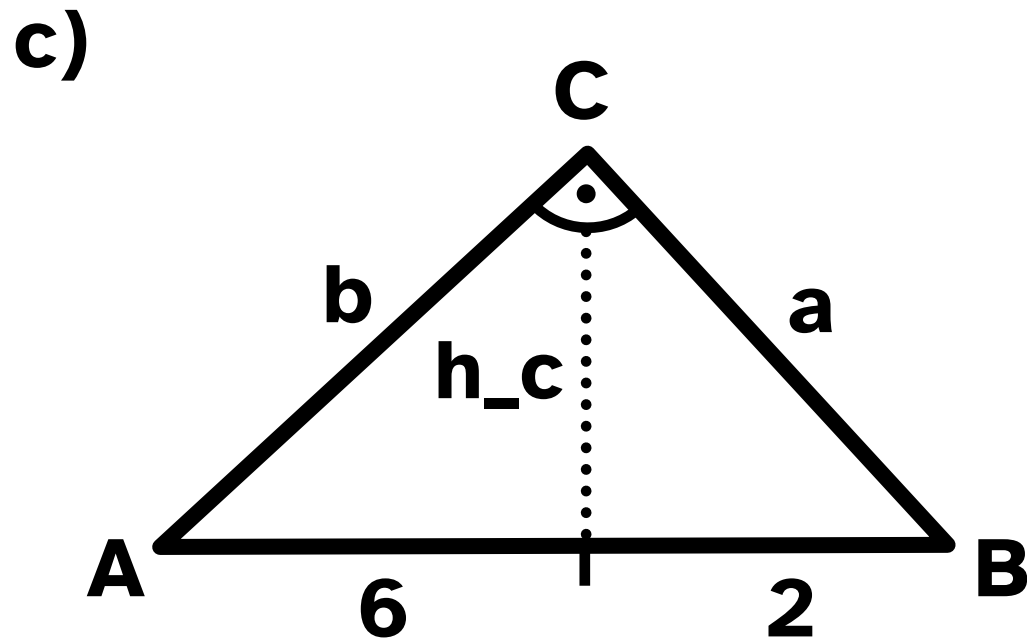
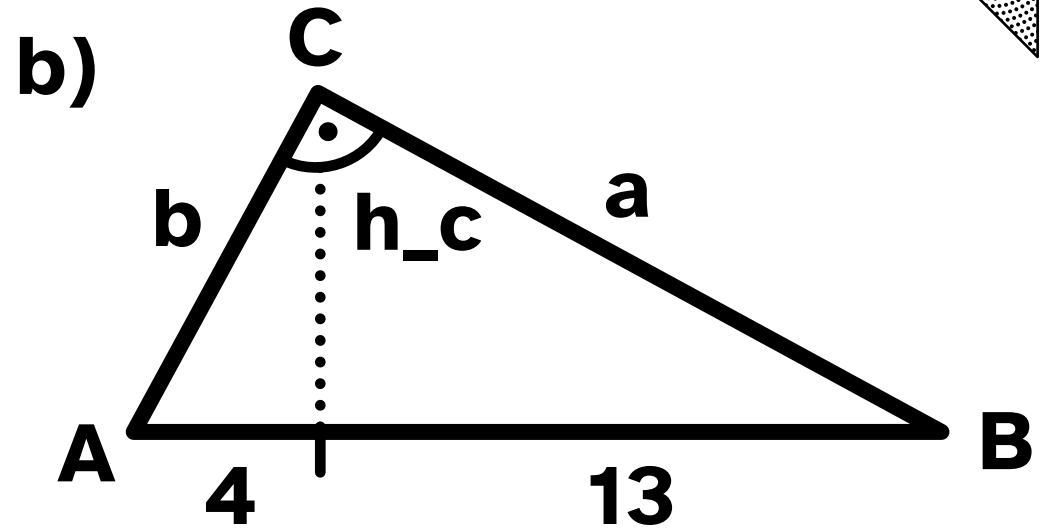
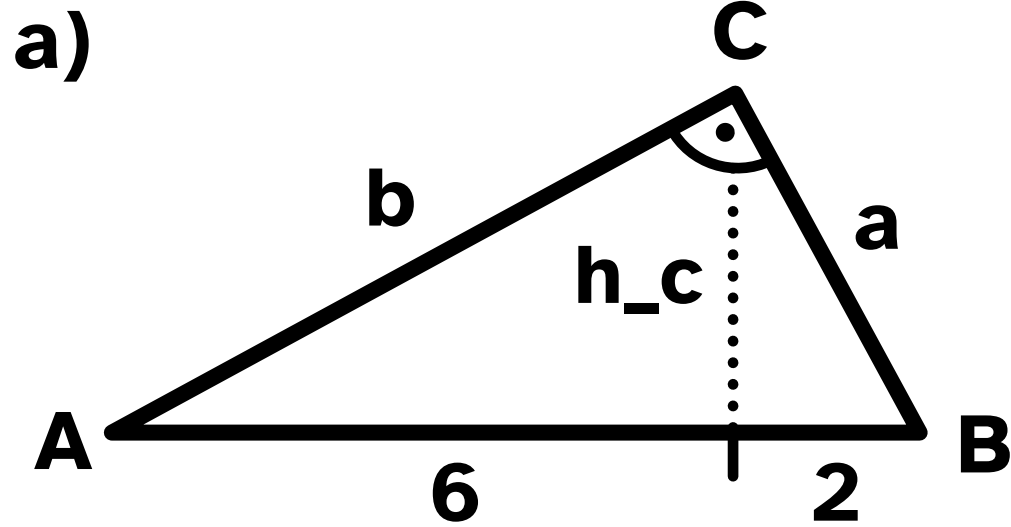
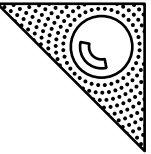

**Plus4**

**S.33 144,145**

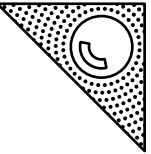

**a)**

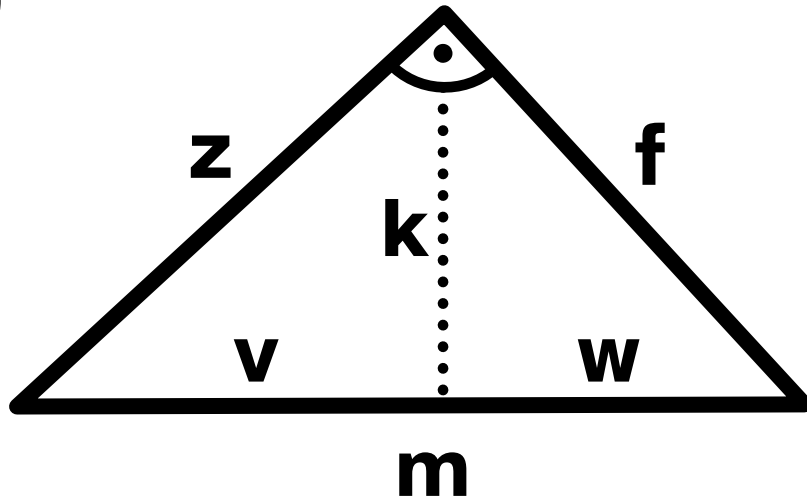

**b)**

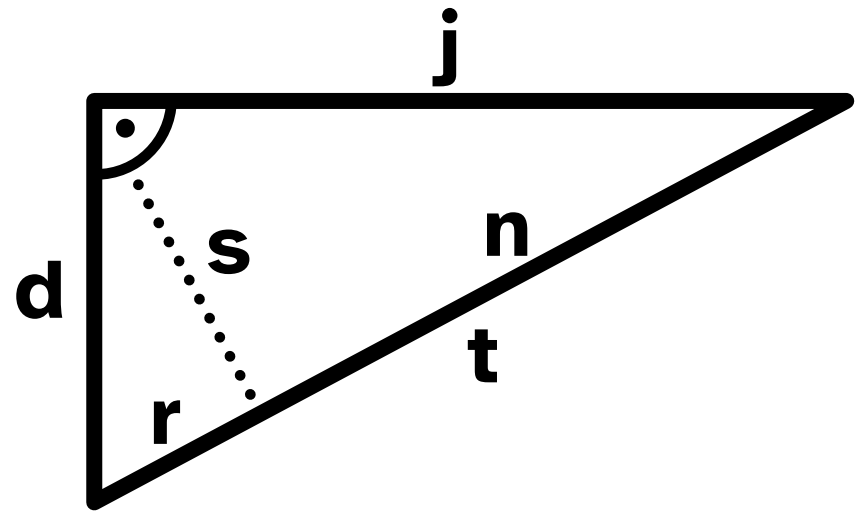

**a)**

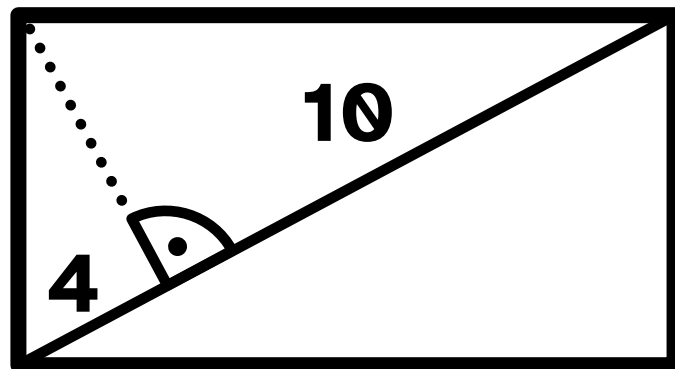

**b)**

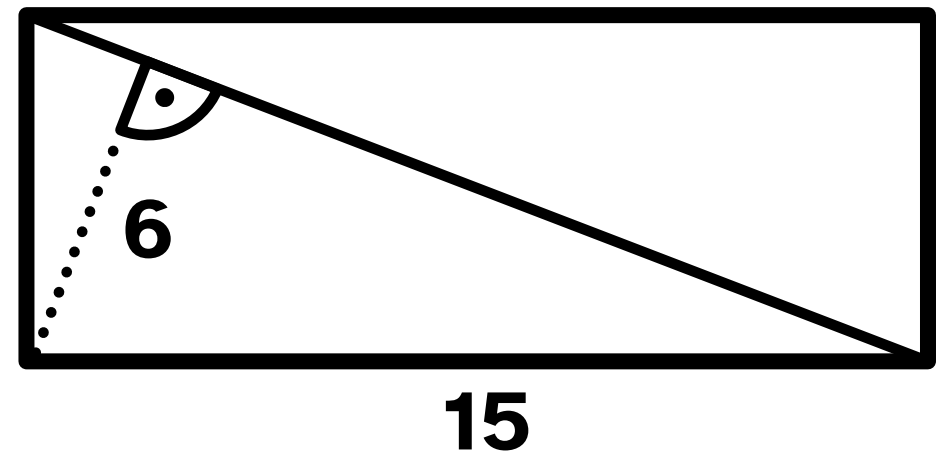

# Plus4 S.34 150, 151, 152

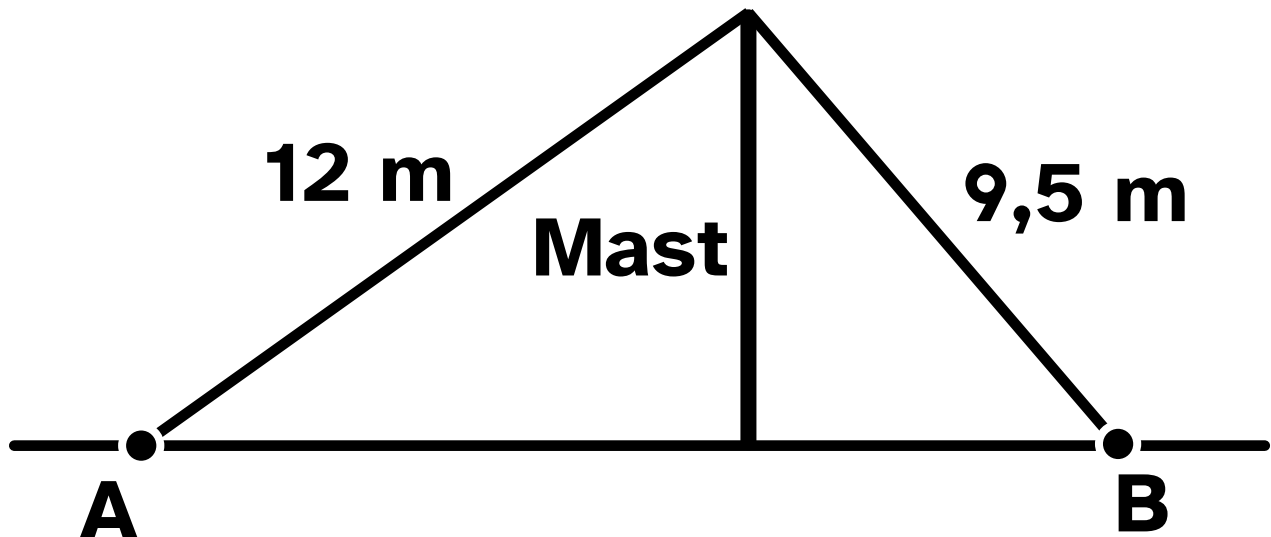
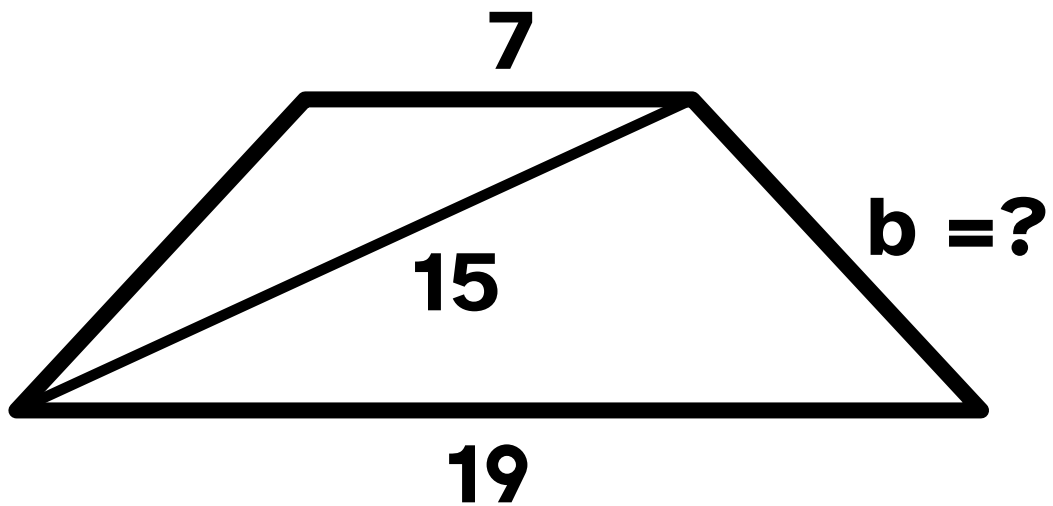
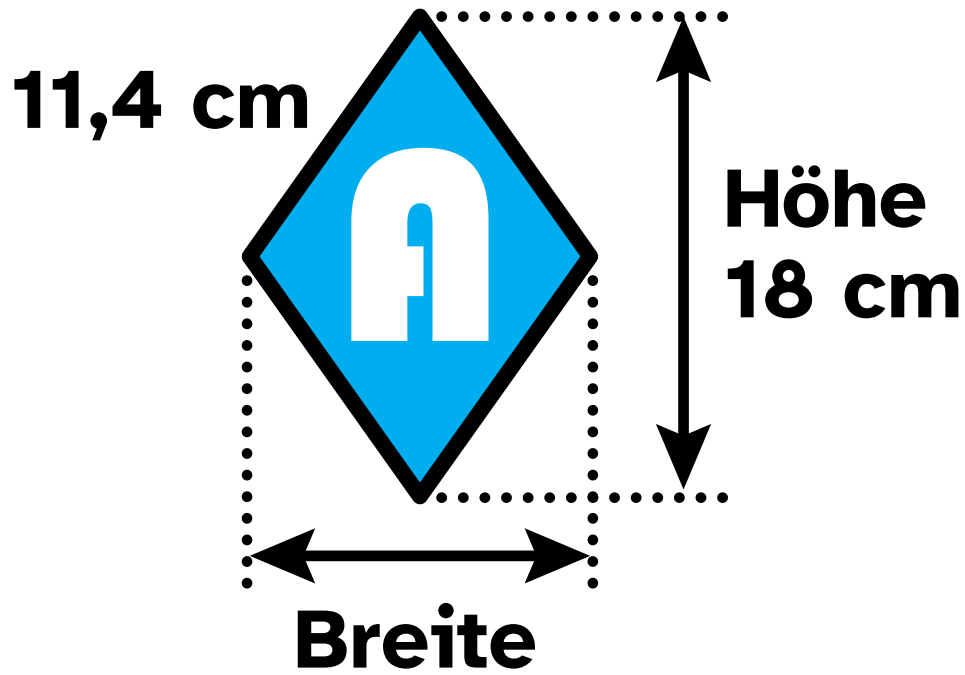
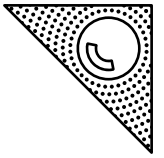



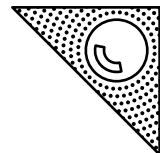

a)

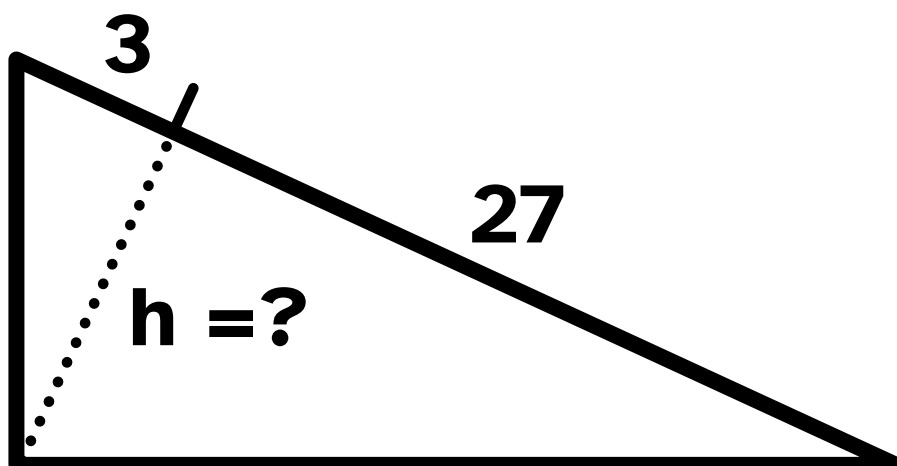

b)

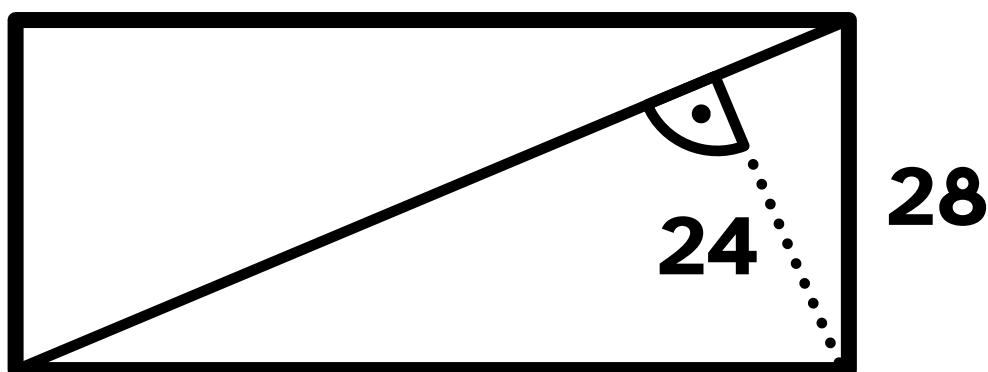
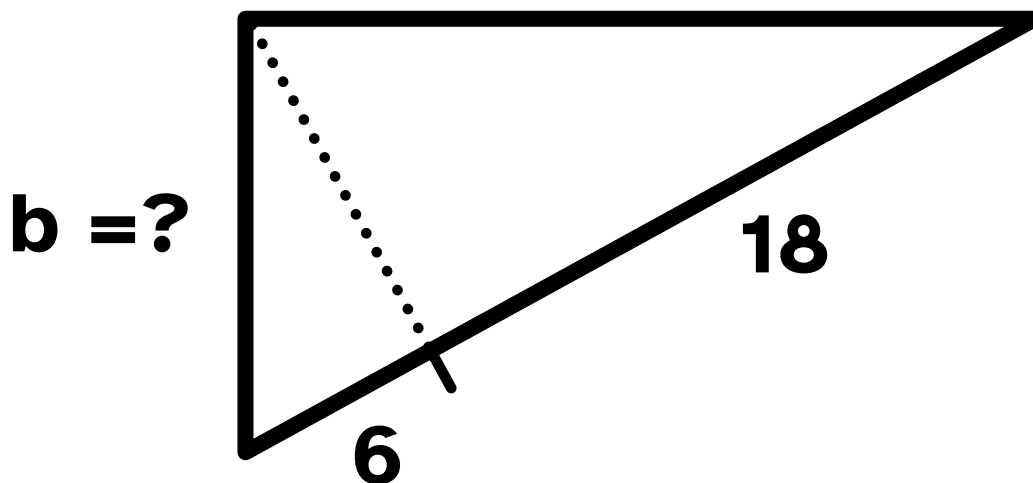

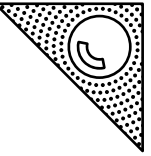

a)

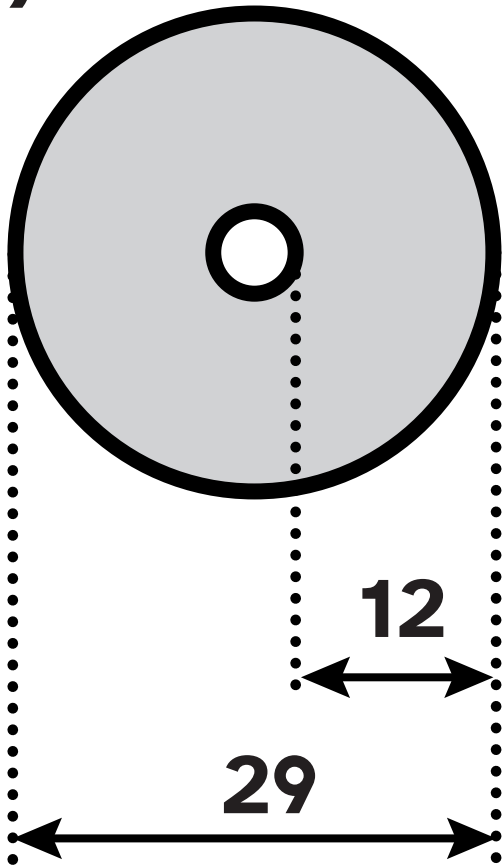

b)

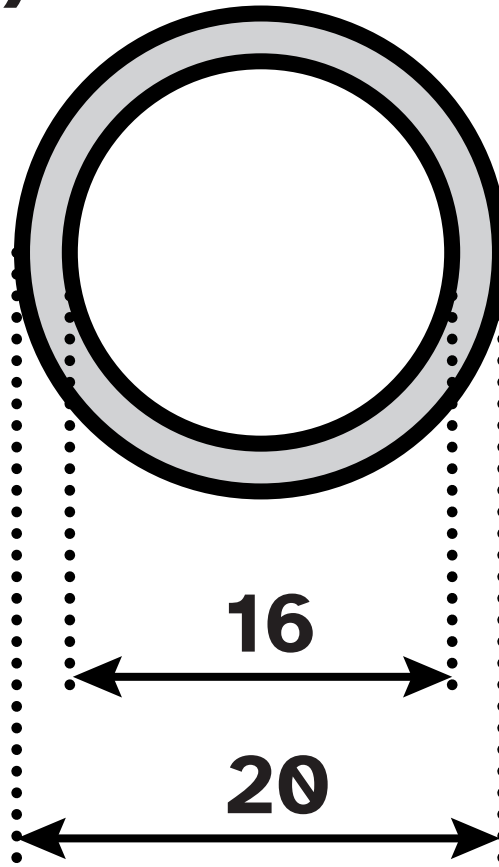

c)

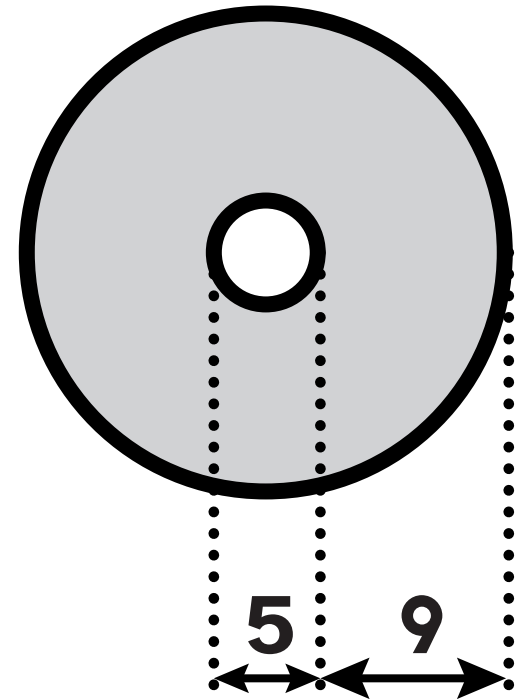

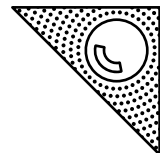

a)

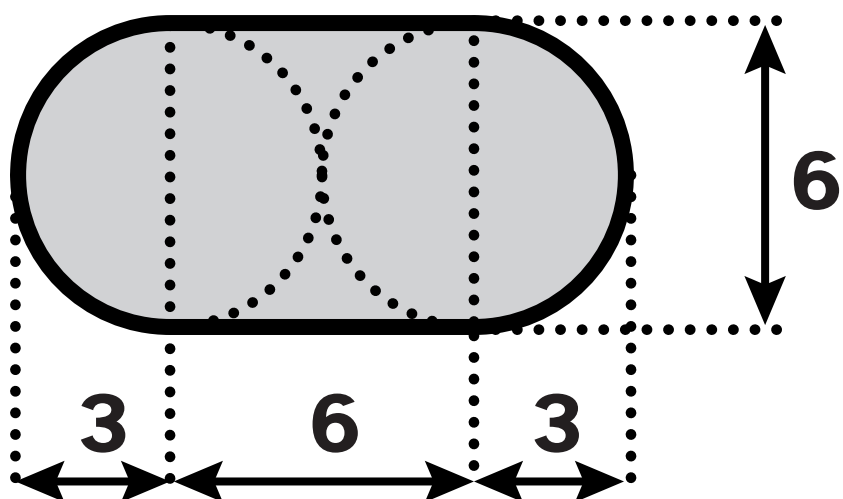

b)

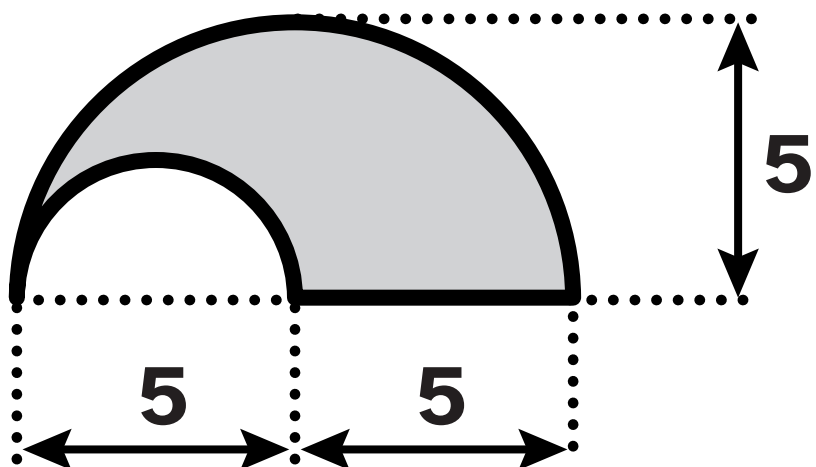

c)

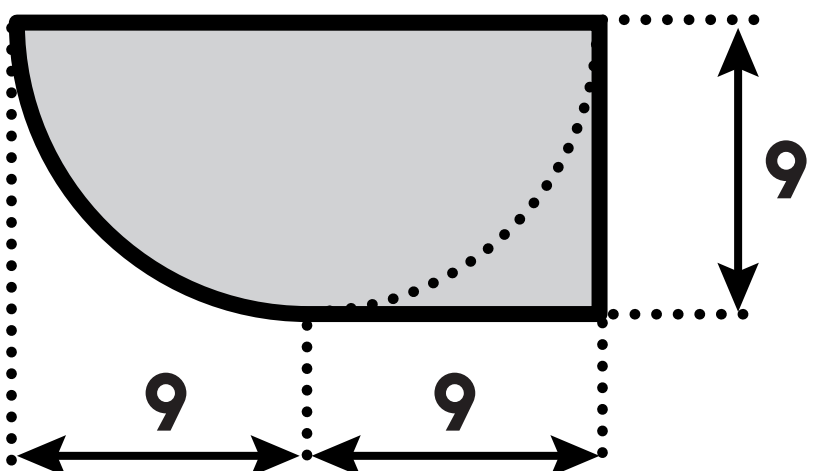

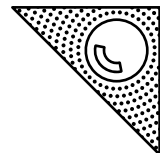

a)

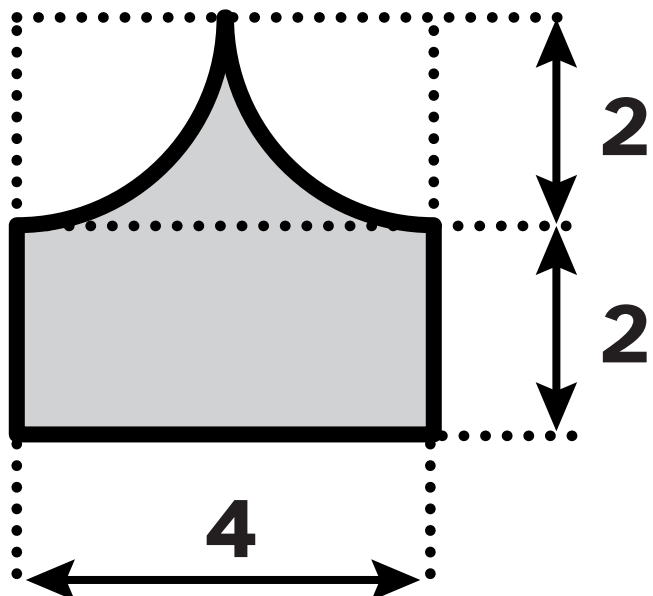

b)

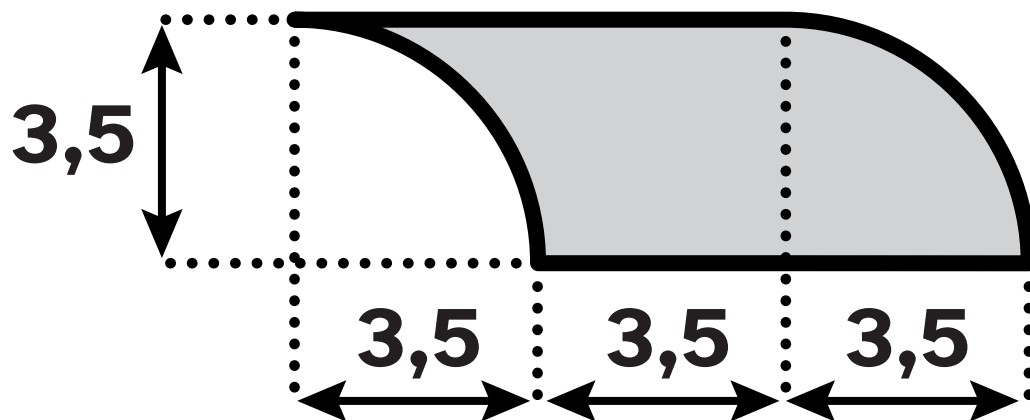

c)

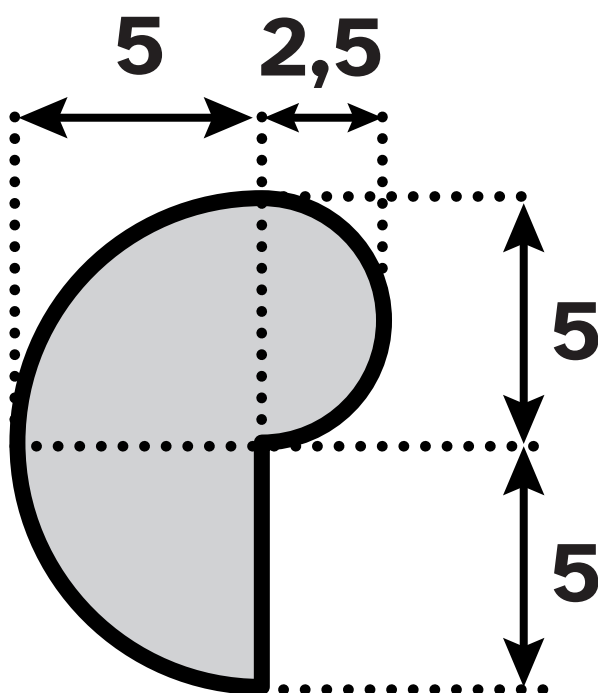

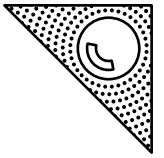

a)

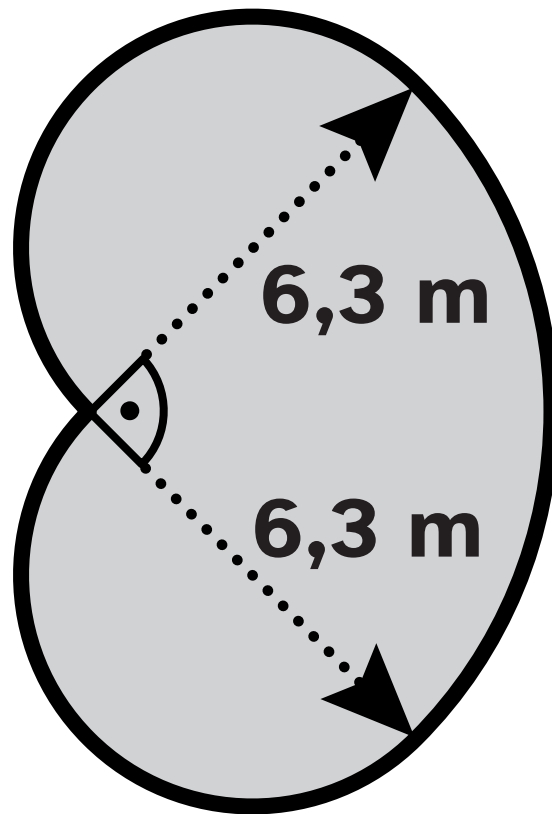

b)

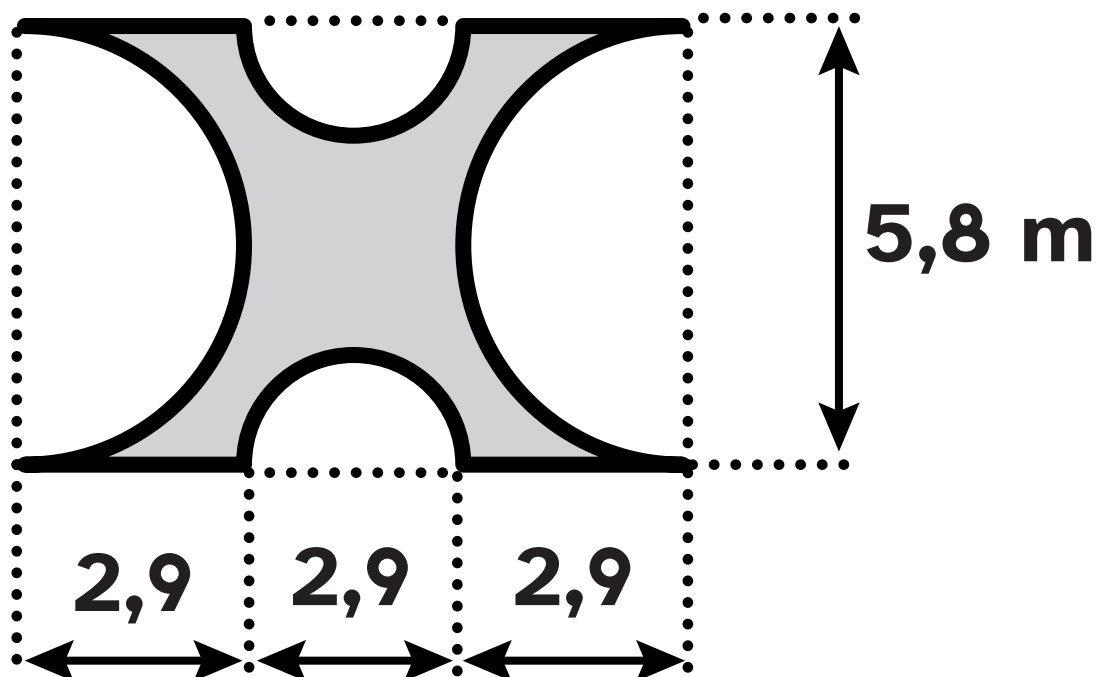

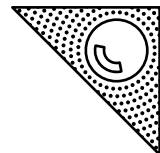

a)

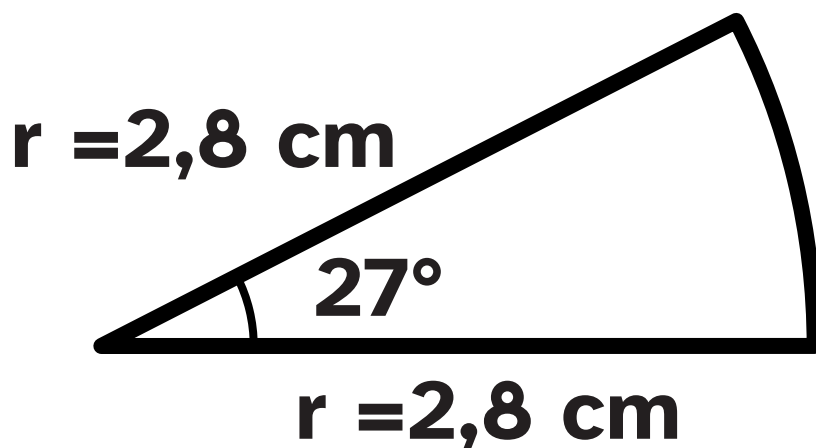

b)

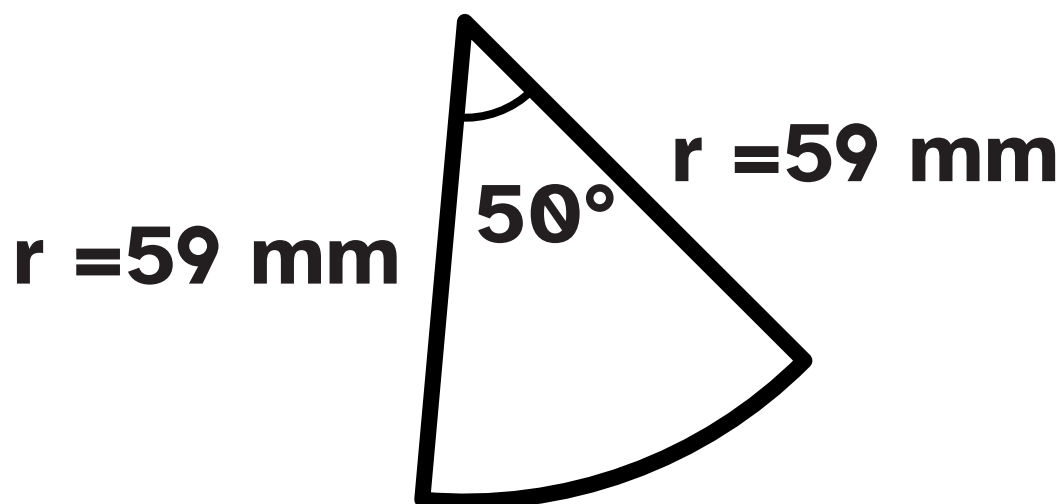

c)

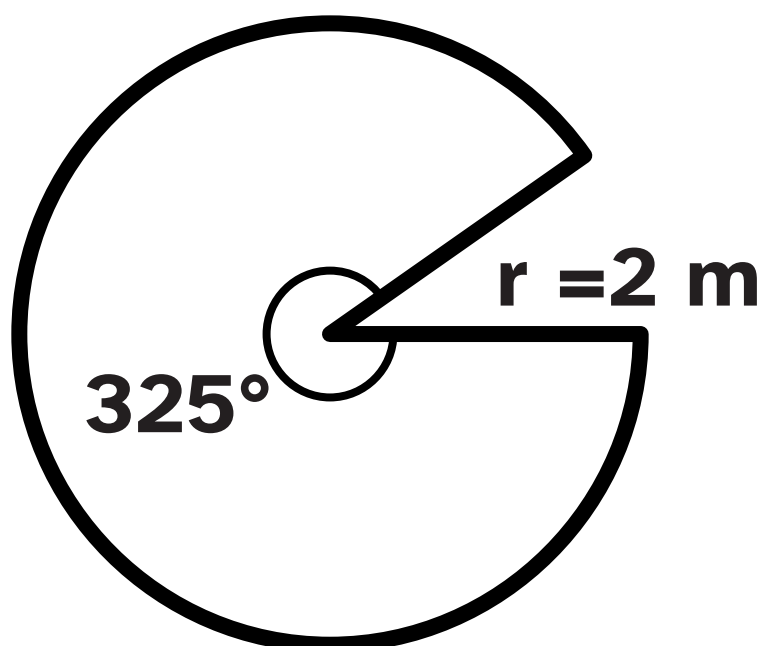

# Plus4 S.80 412, 413, 414

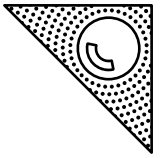

412

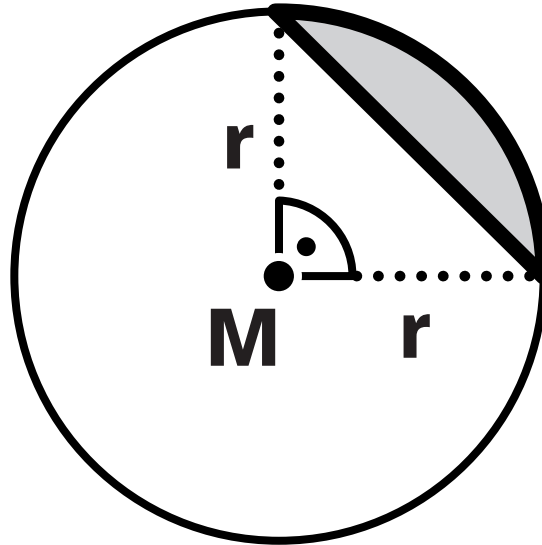

---

---

413

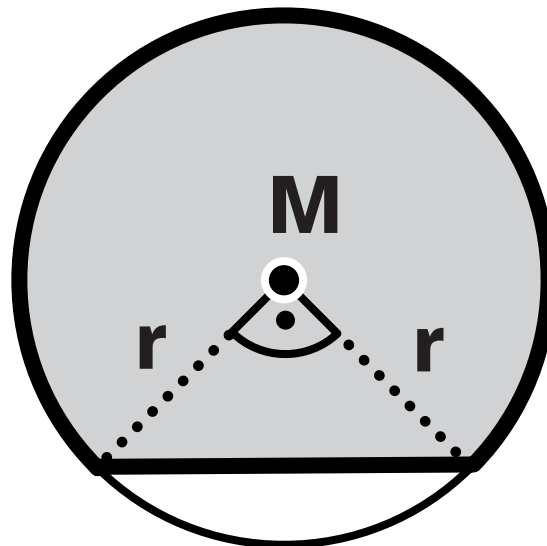

---

---

414

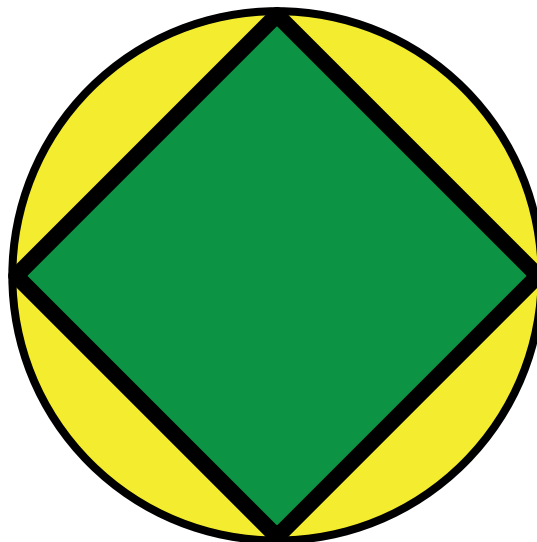

Plus4  
415

S.80 415, 416

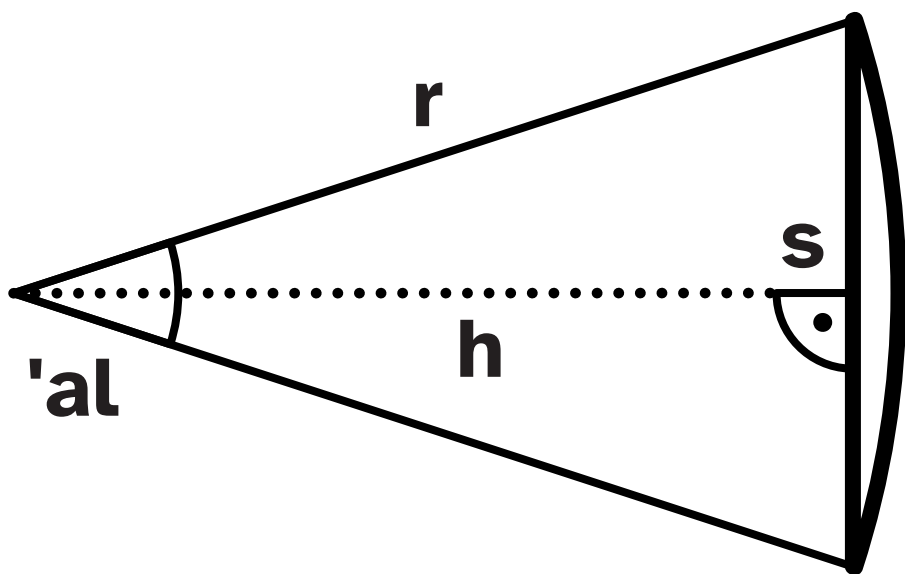
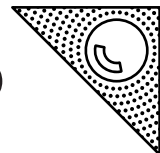

---

---

416

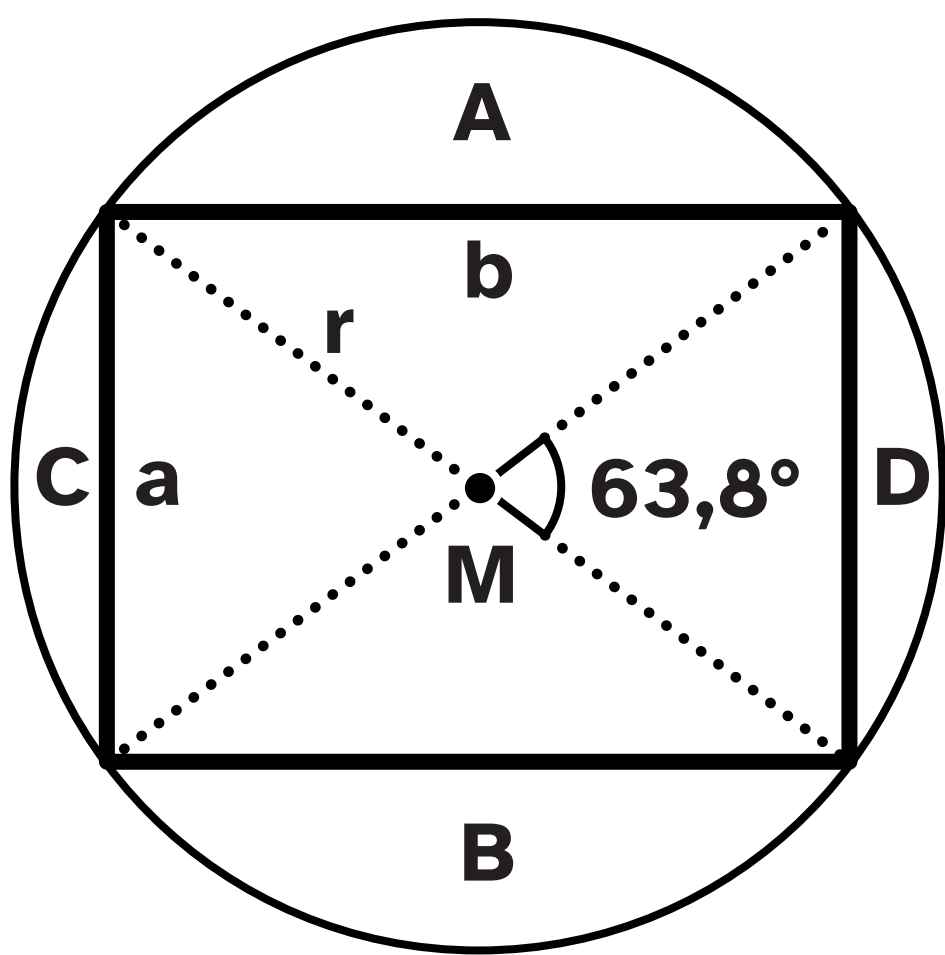



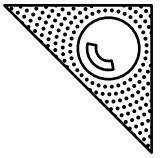

418

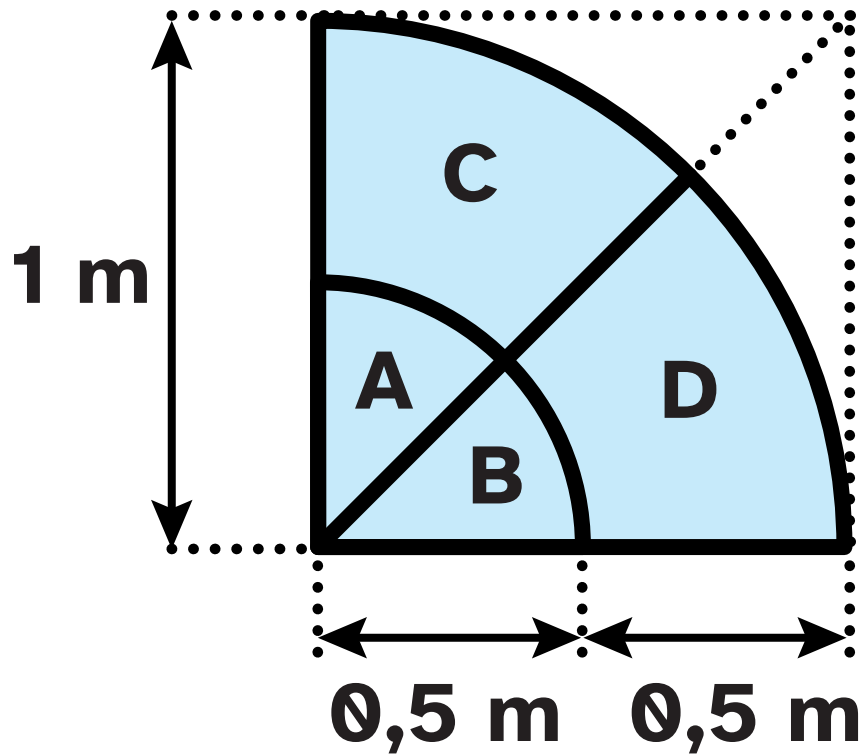

---

---

420

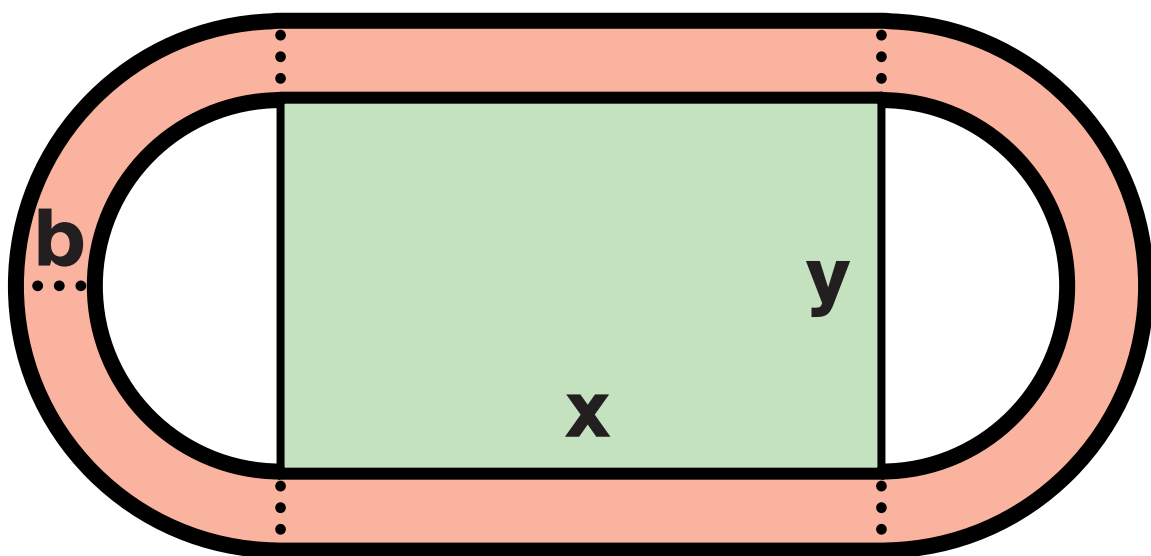

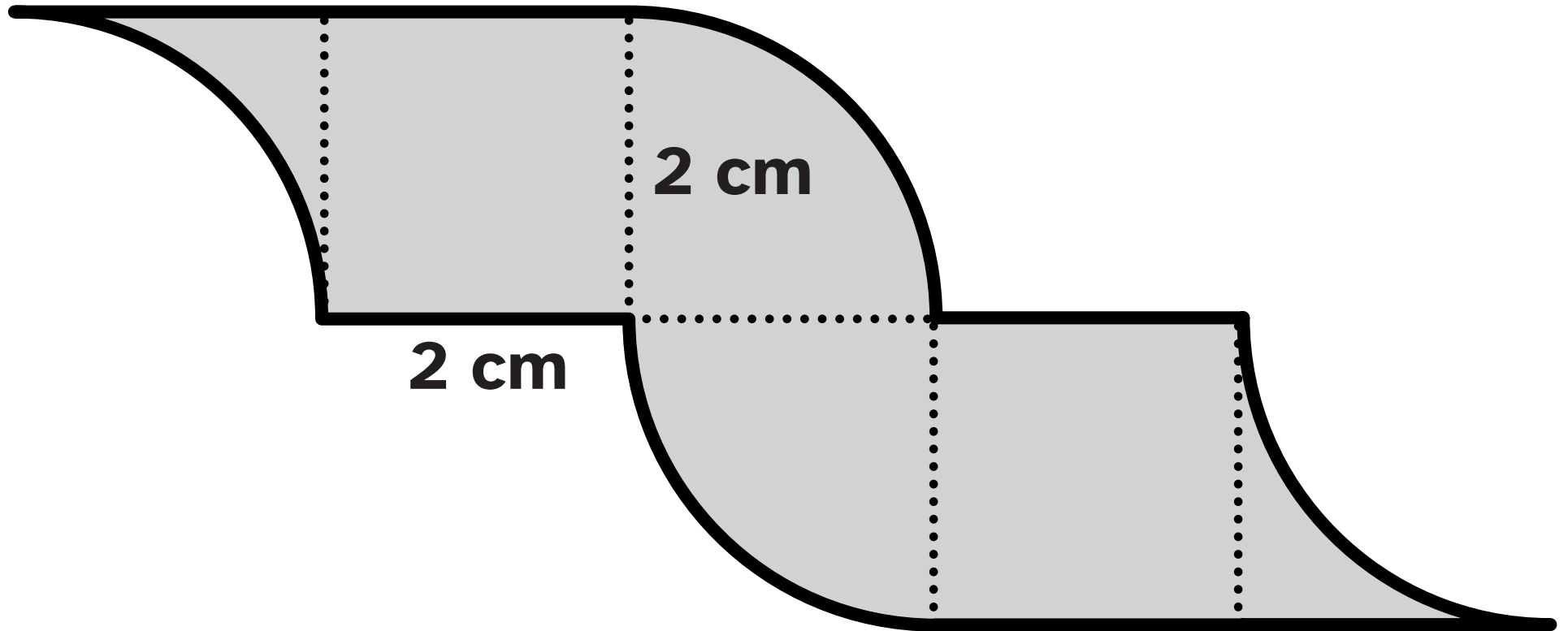
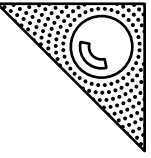

**Plus4**

**S.82 428, 429**

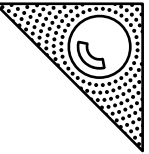

**a)**

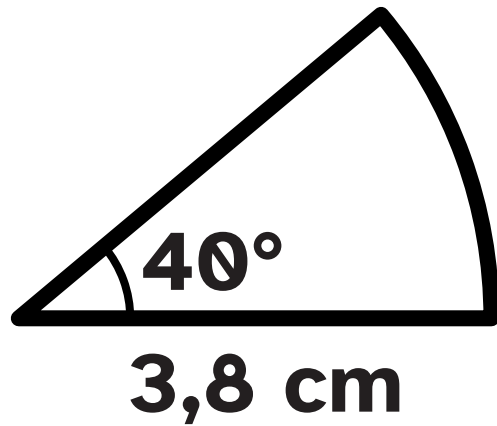

**b)**

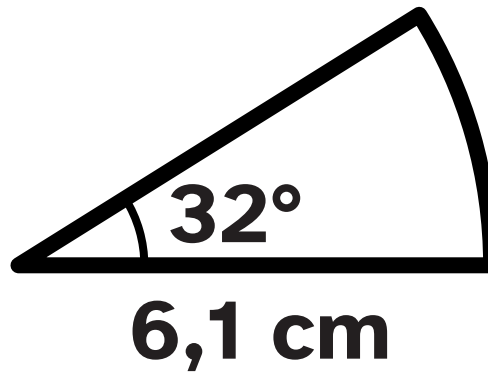

**c)**

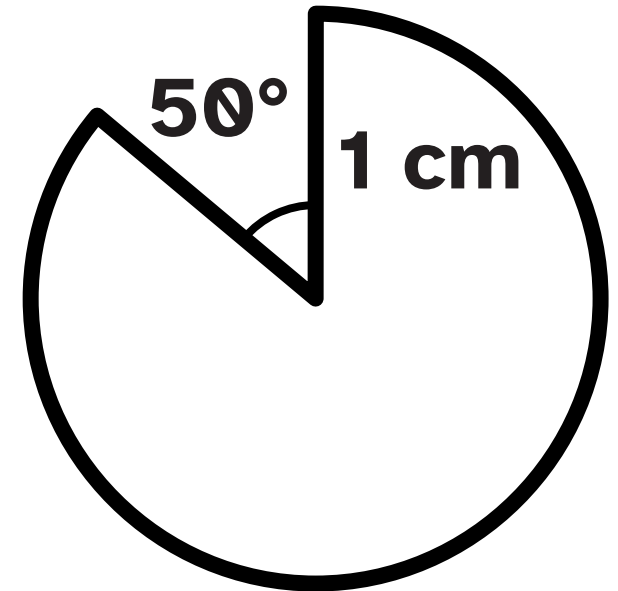

---

**429**

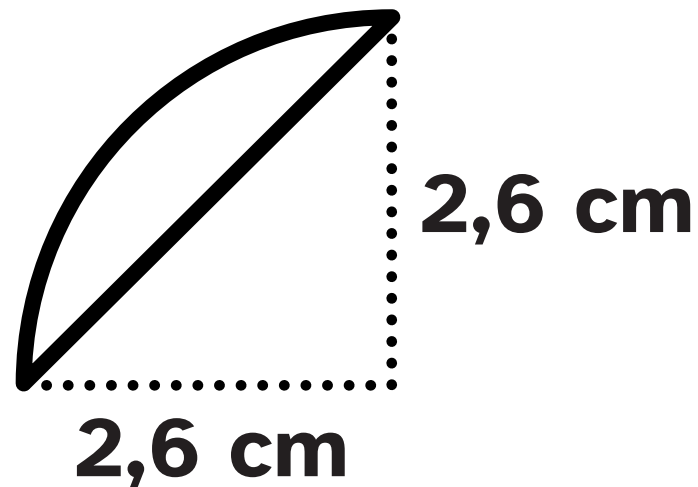

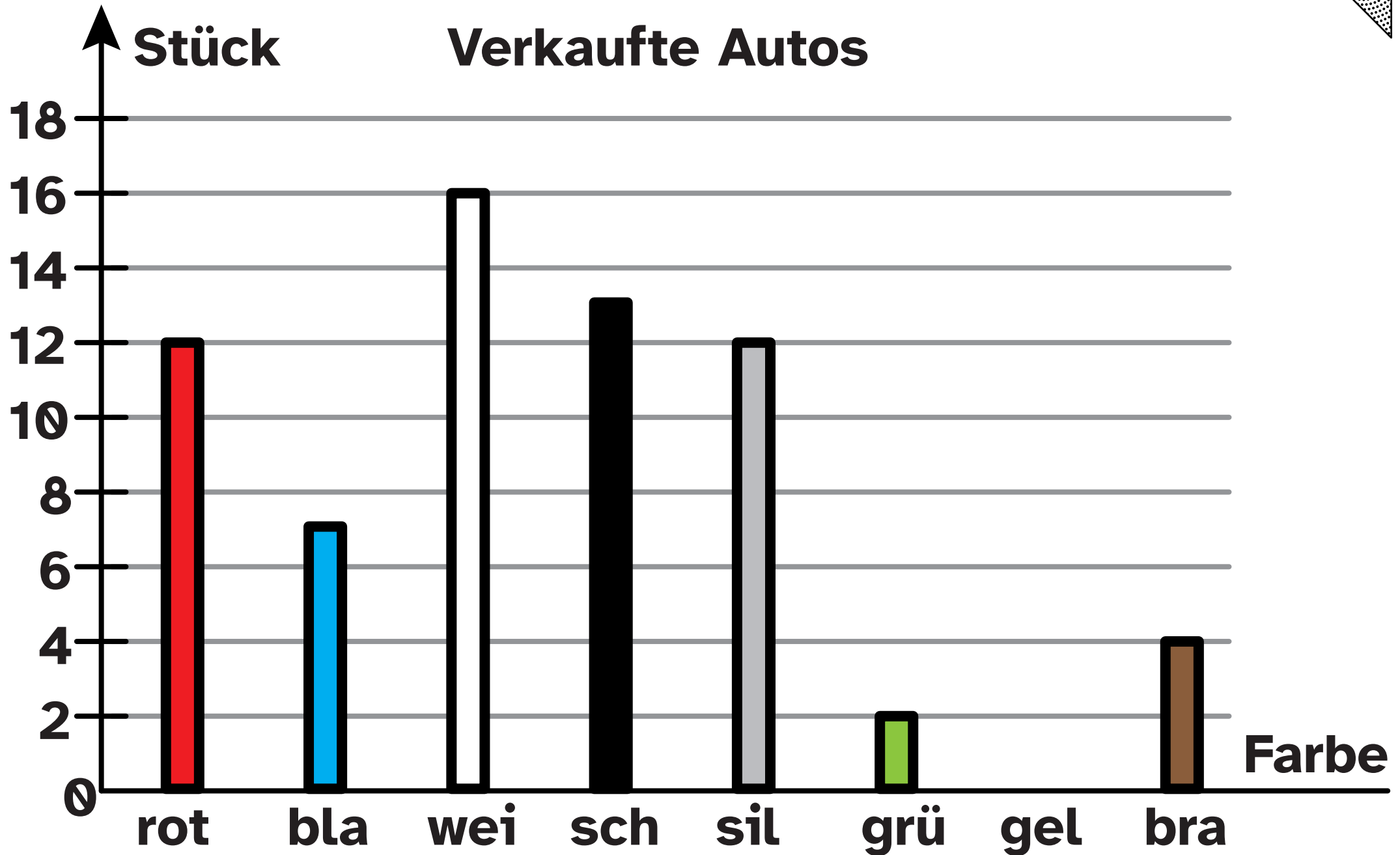
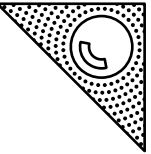

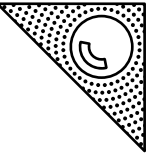

Anzahl der Personen

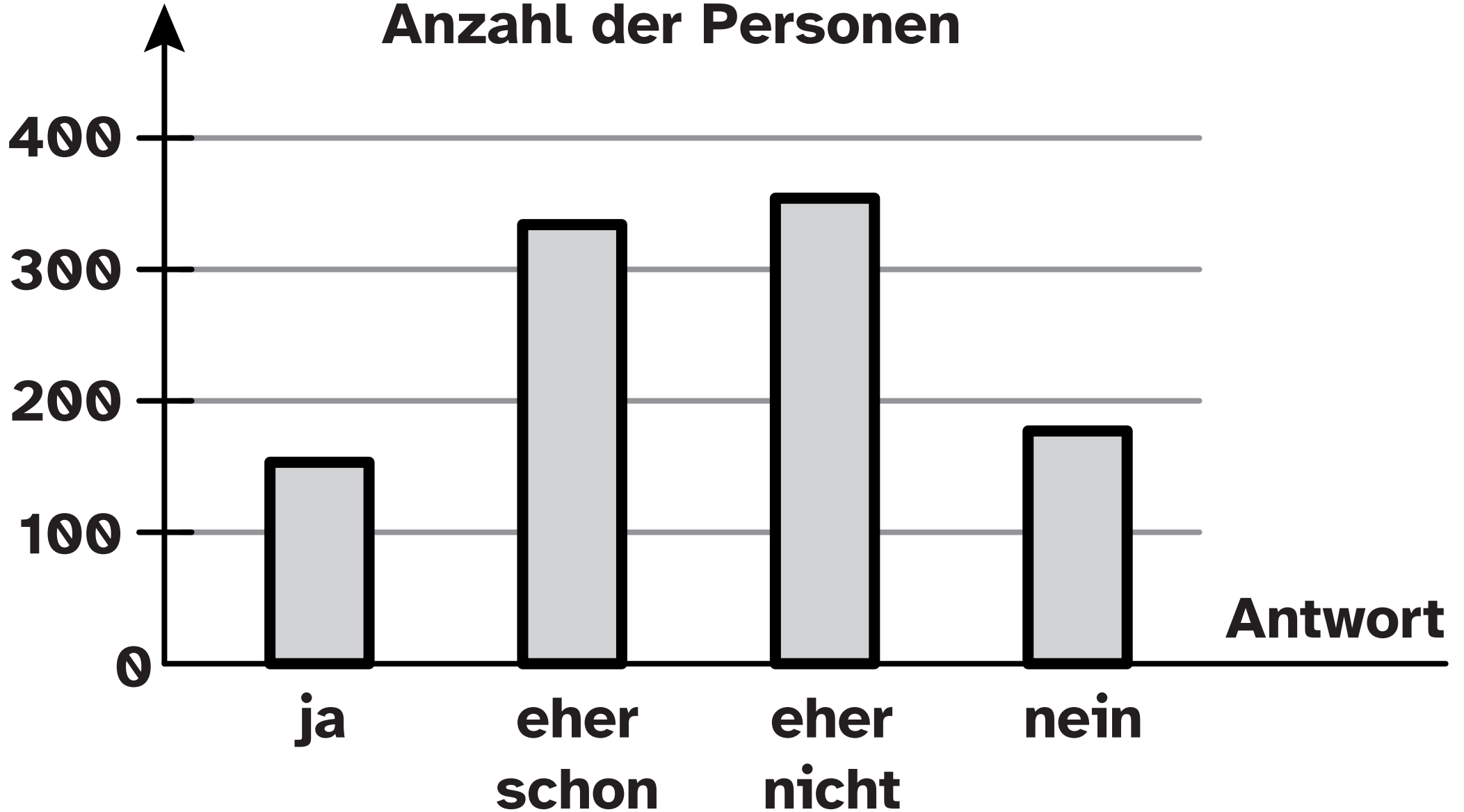

# Plus4

S.87 444

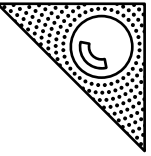

Geld (in Tausend EUR)

 Ausgaben

 Einnahmen

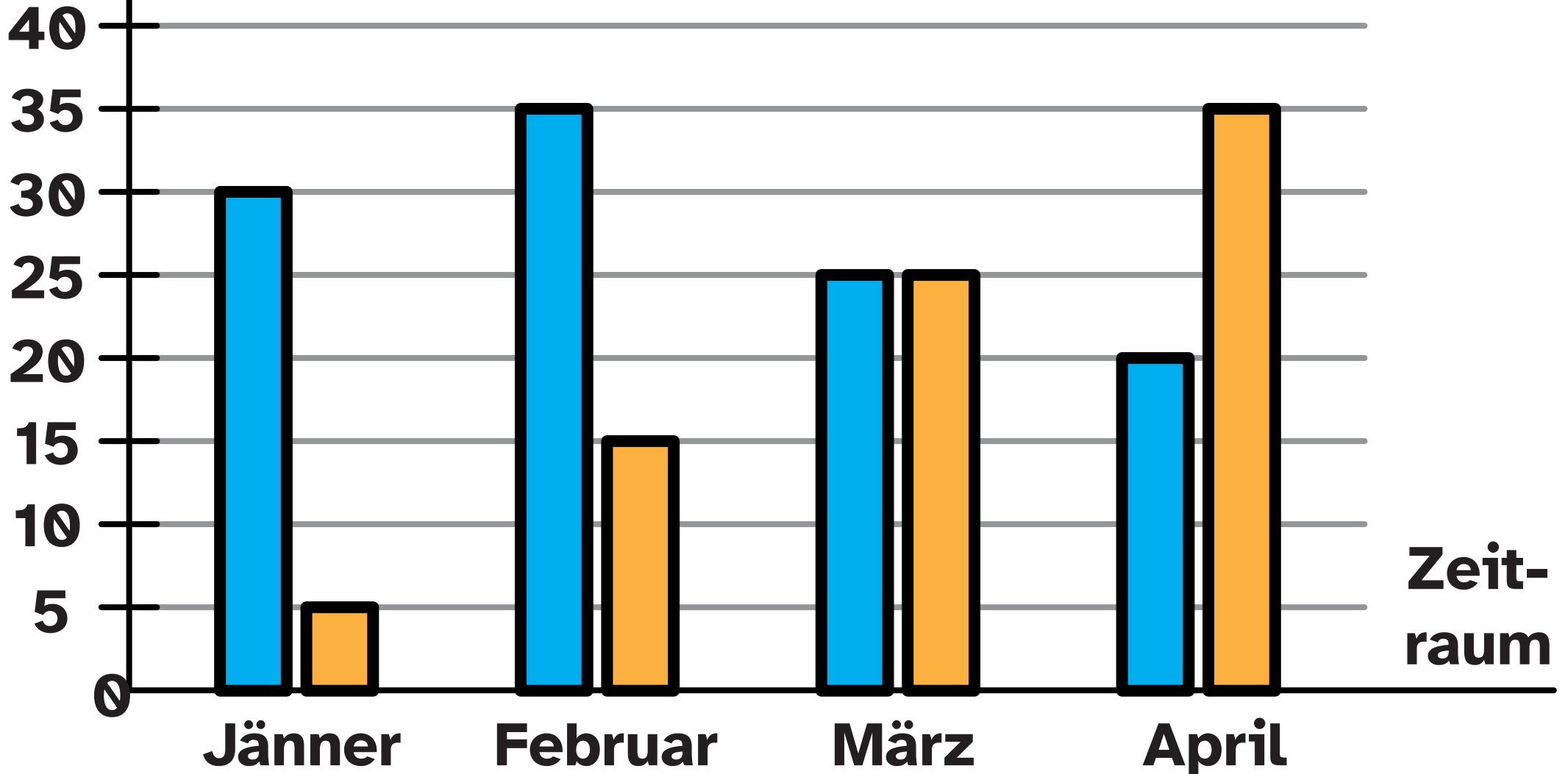

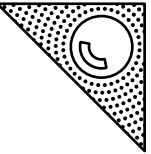

 16-19 Jahre

 30-49 Jahre

 über 50 Jahre

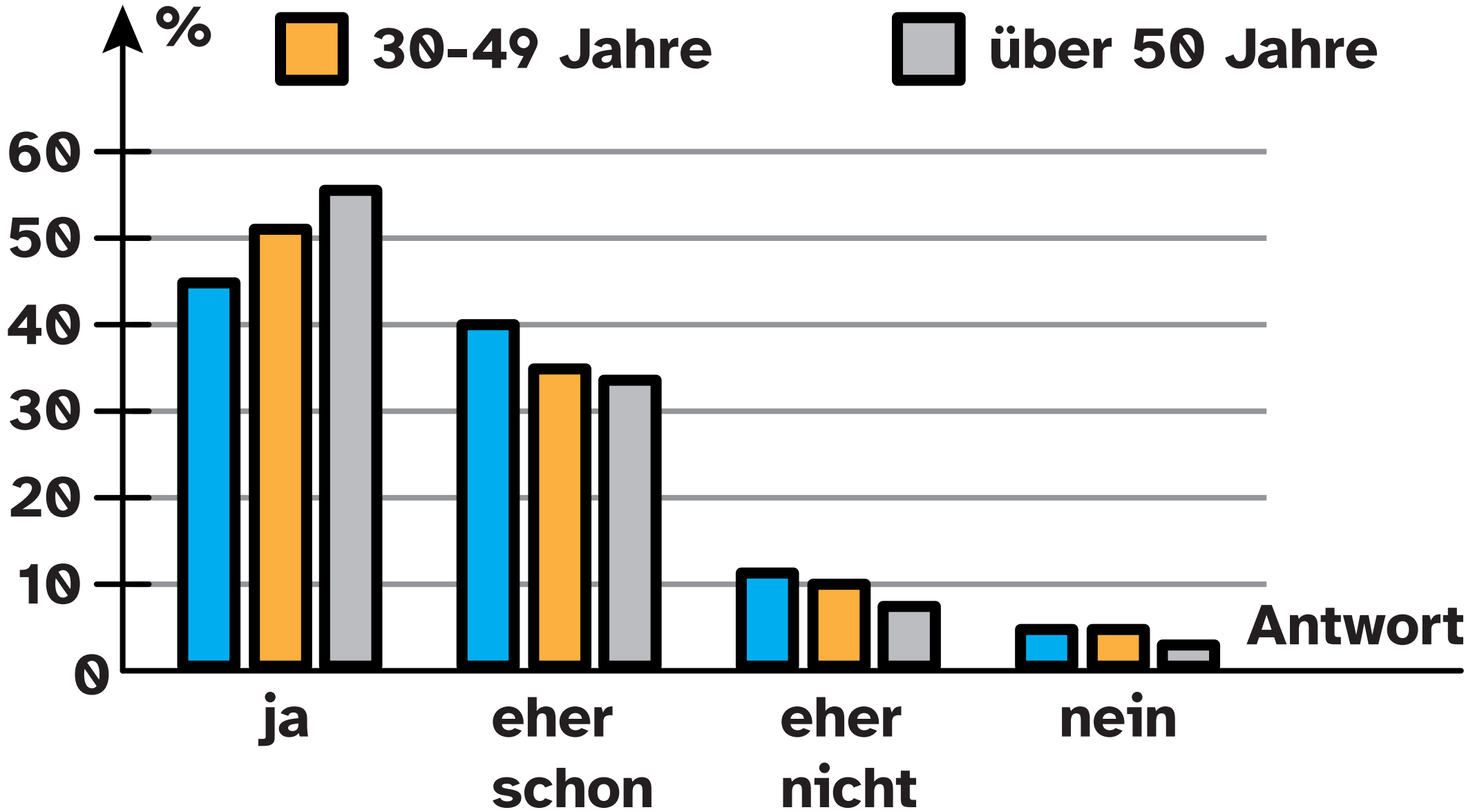

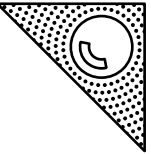

↑ Einnahmen (EUR)

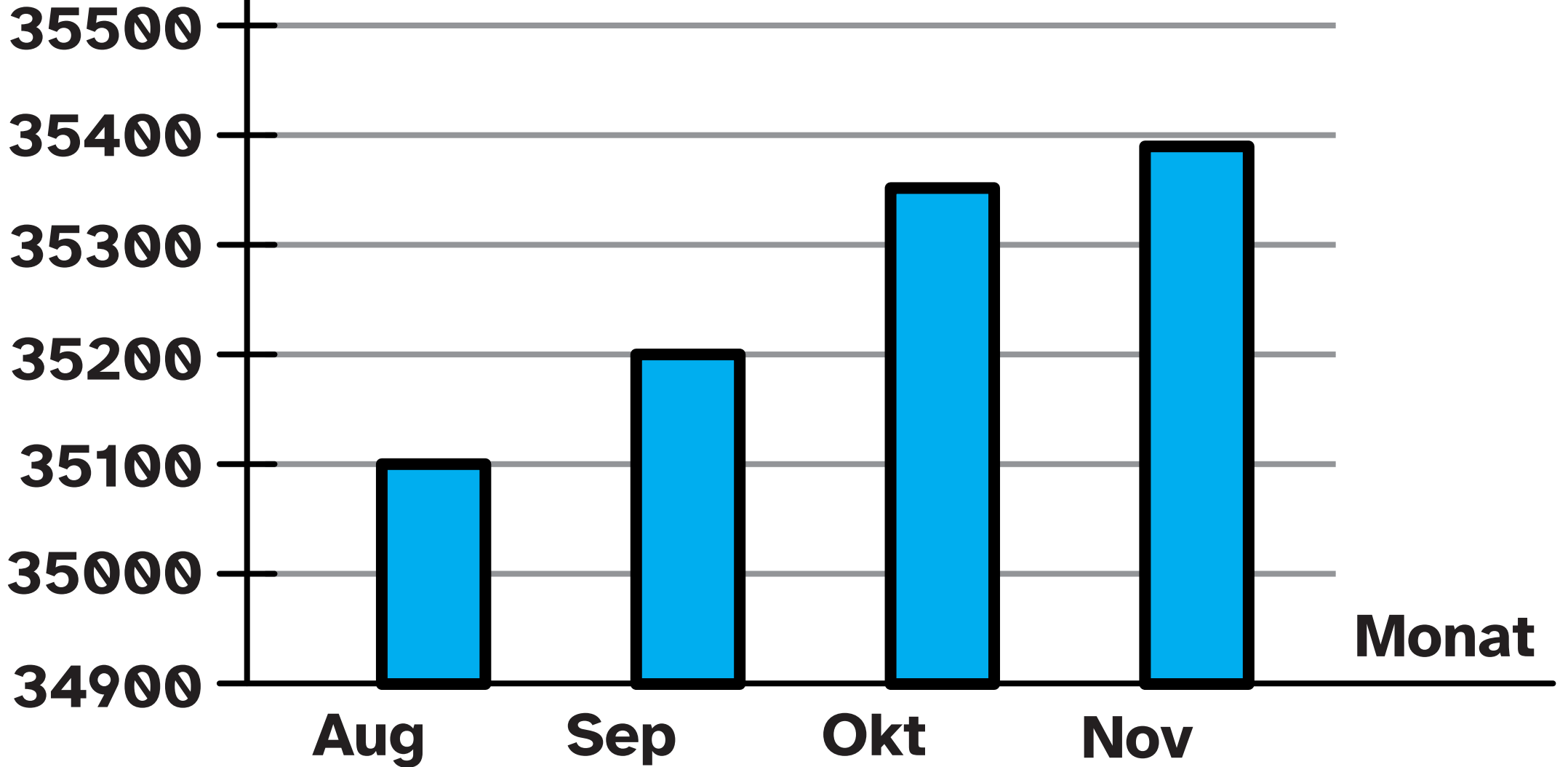



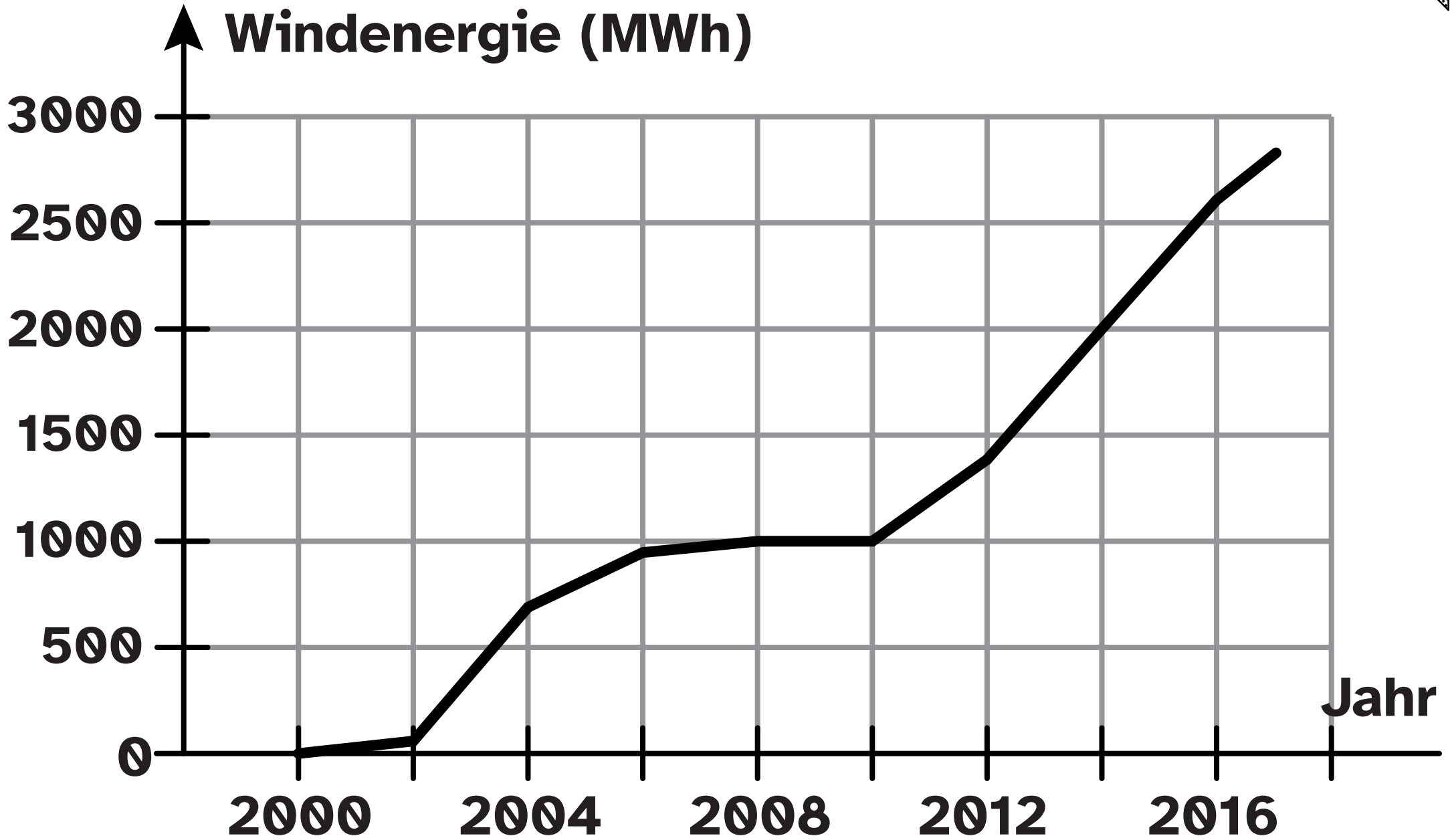
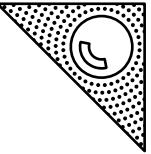

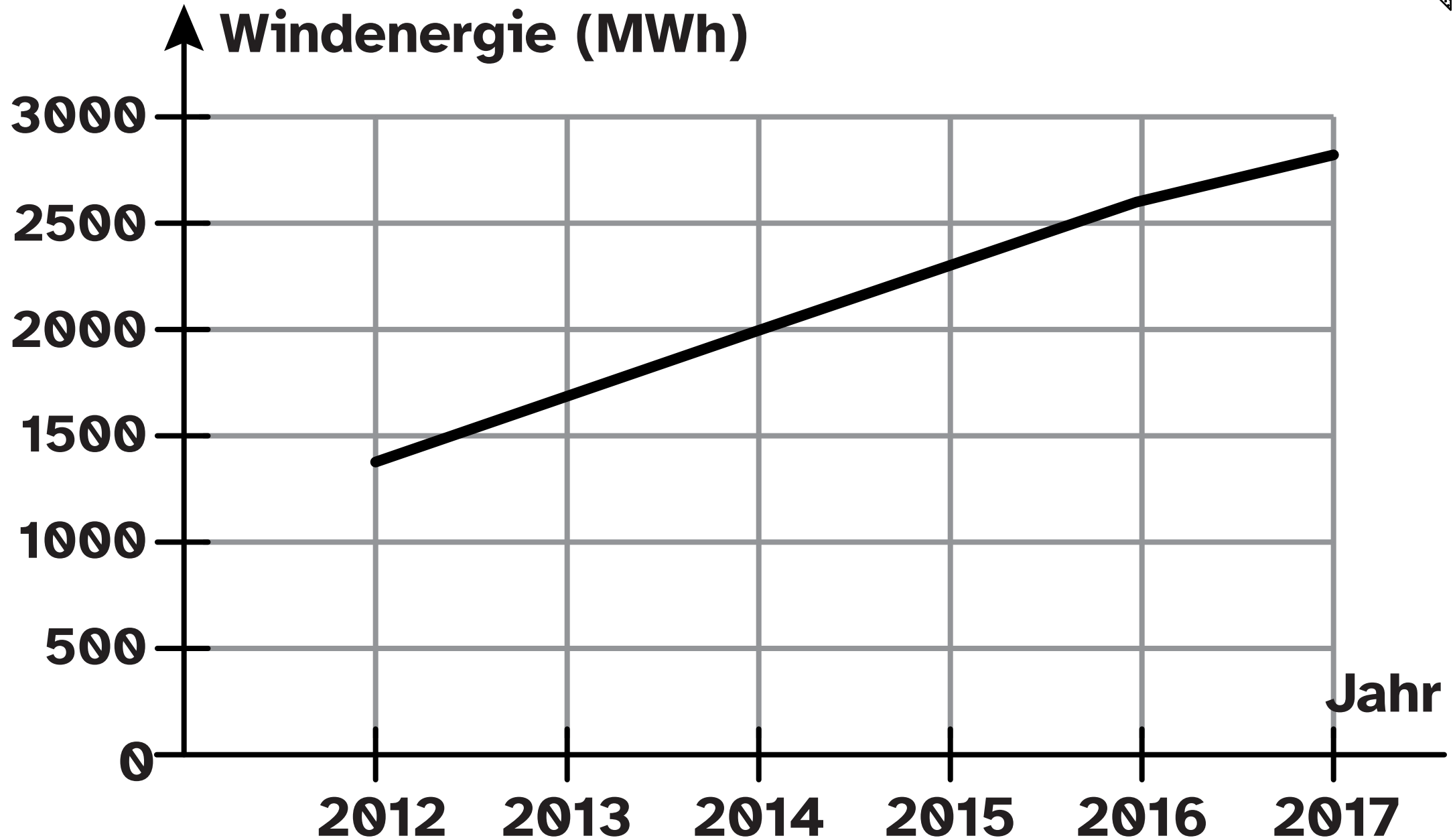
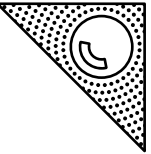

# Plus4

# S.90 460

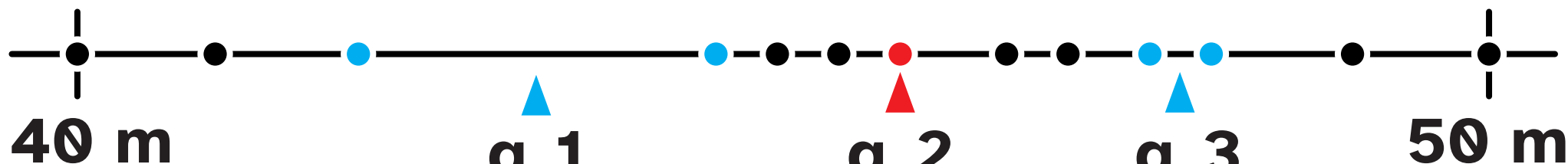
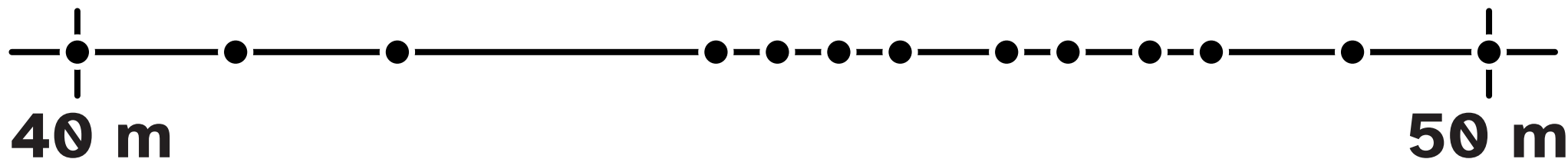
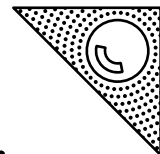

**Median**      **Median**      **Median**  
**untere Hälfte**      **obere Hälfte**

## Boxplot-Diagramm:



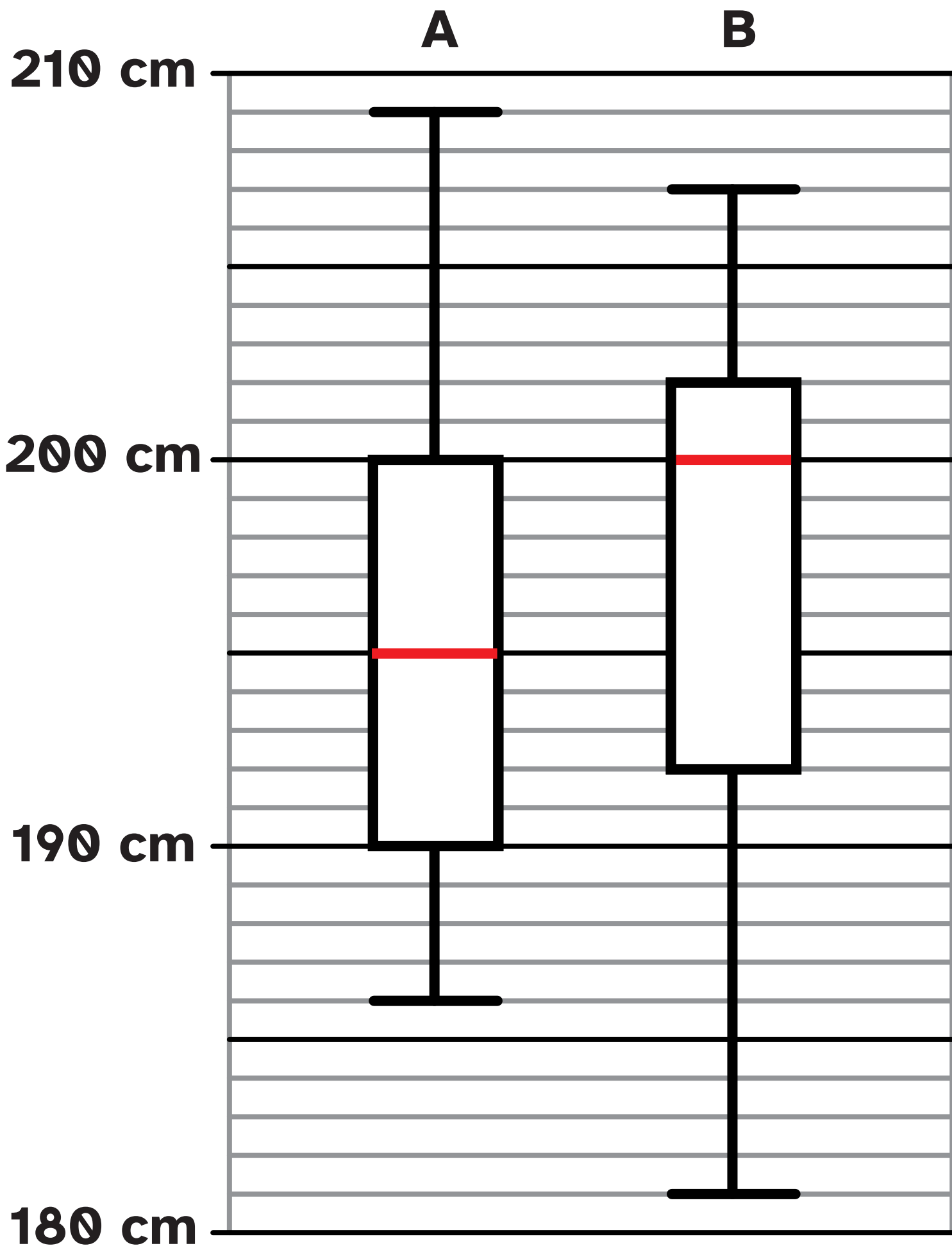
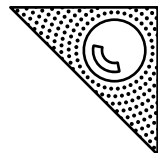

**Plus4**

**S.93 463**

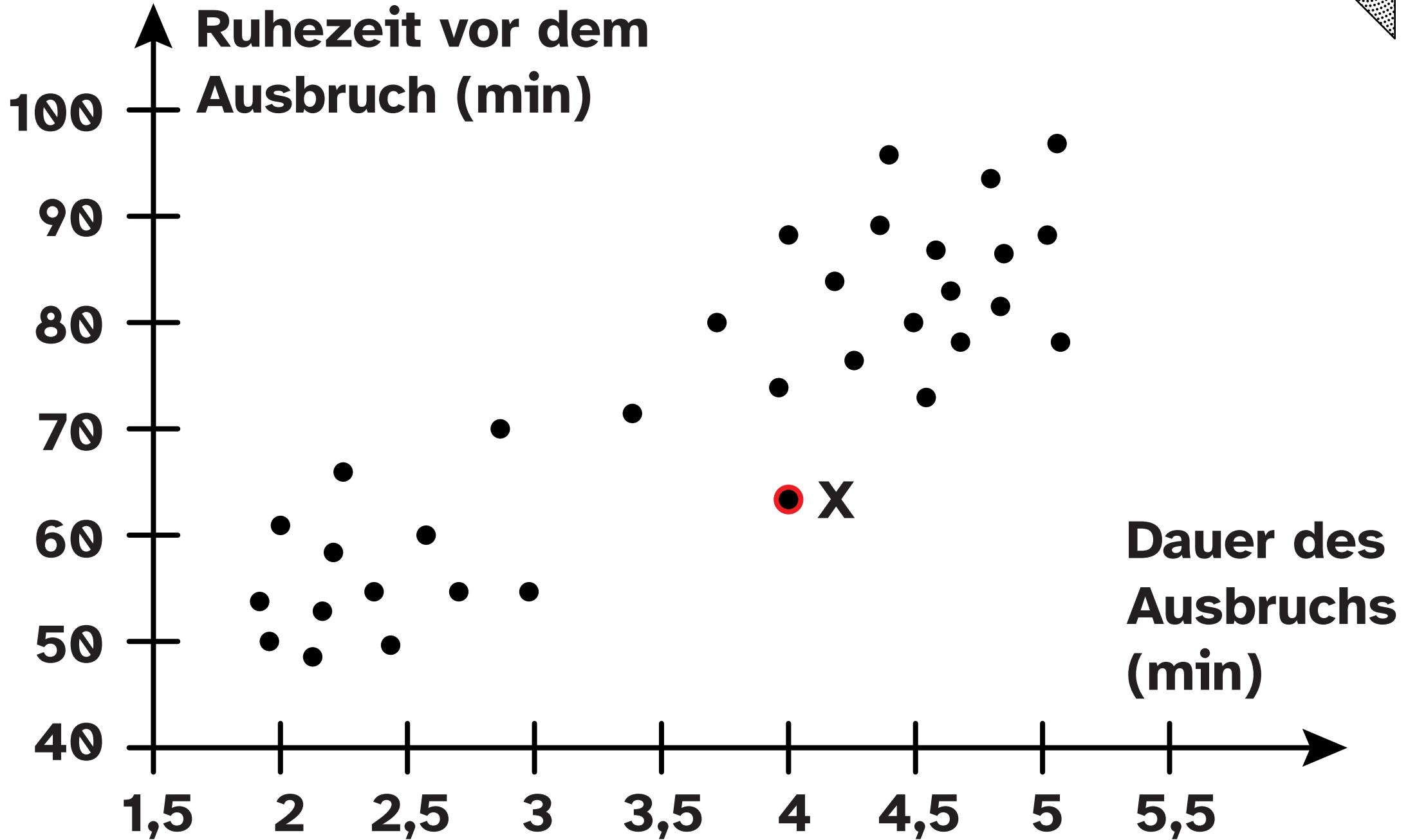
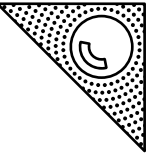

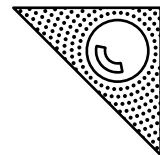

a)



b)

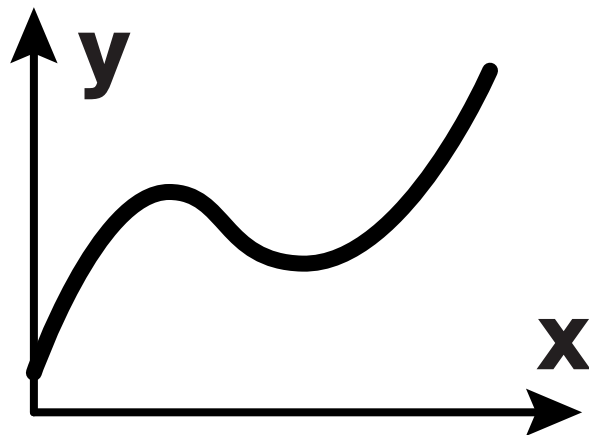

c)

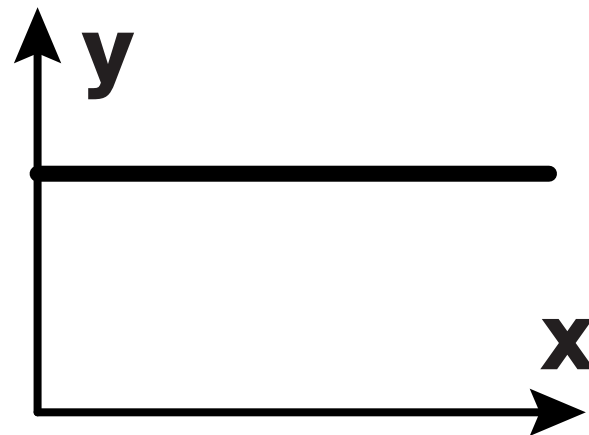

d)

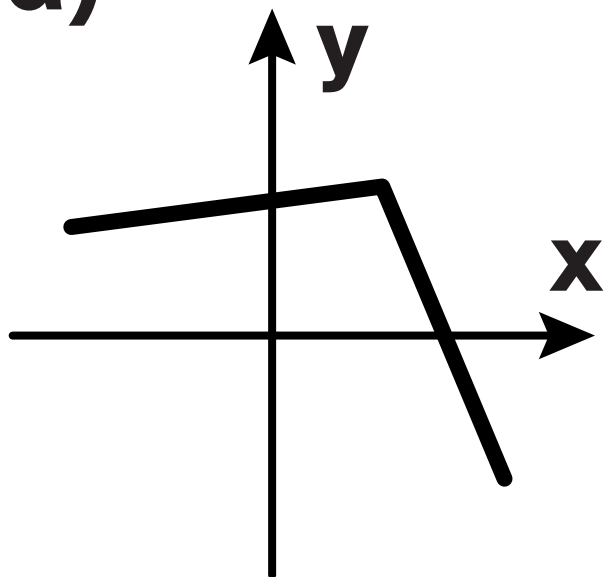

e)

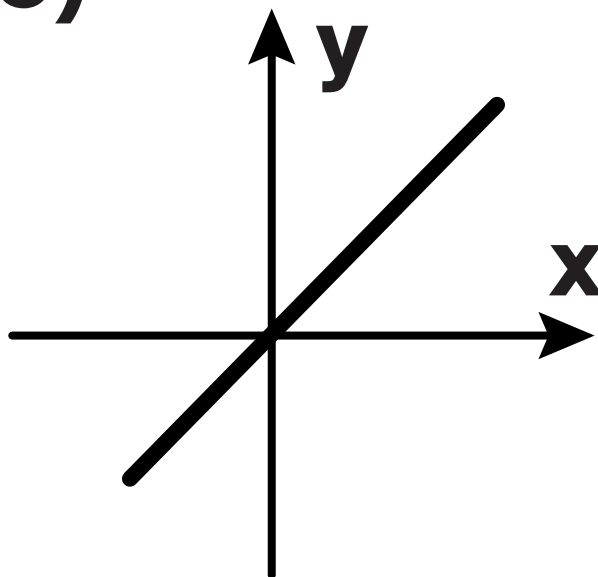

f)

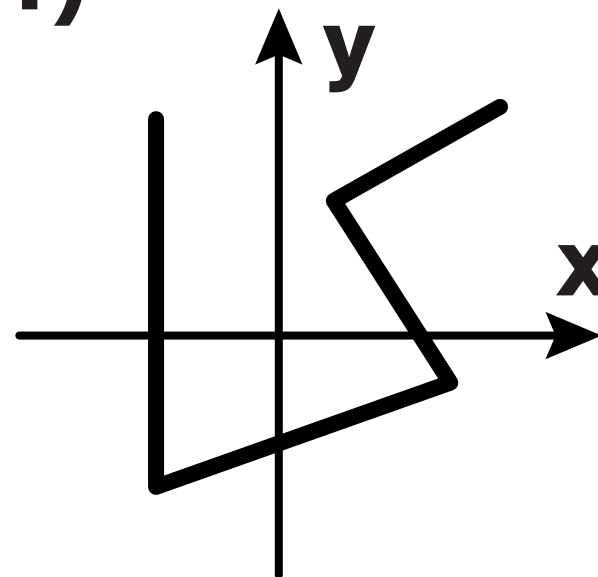

# Plus4 S.122 621, 622, 623

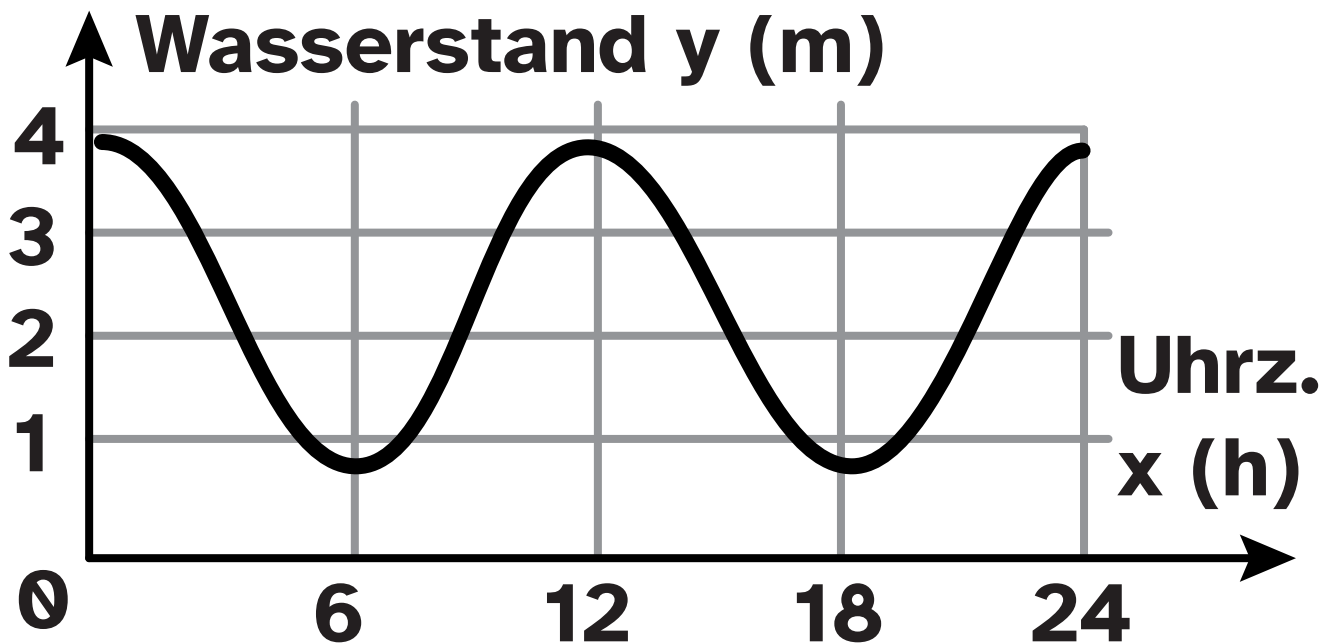
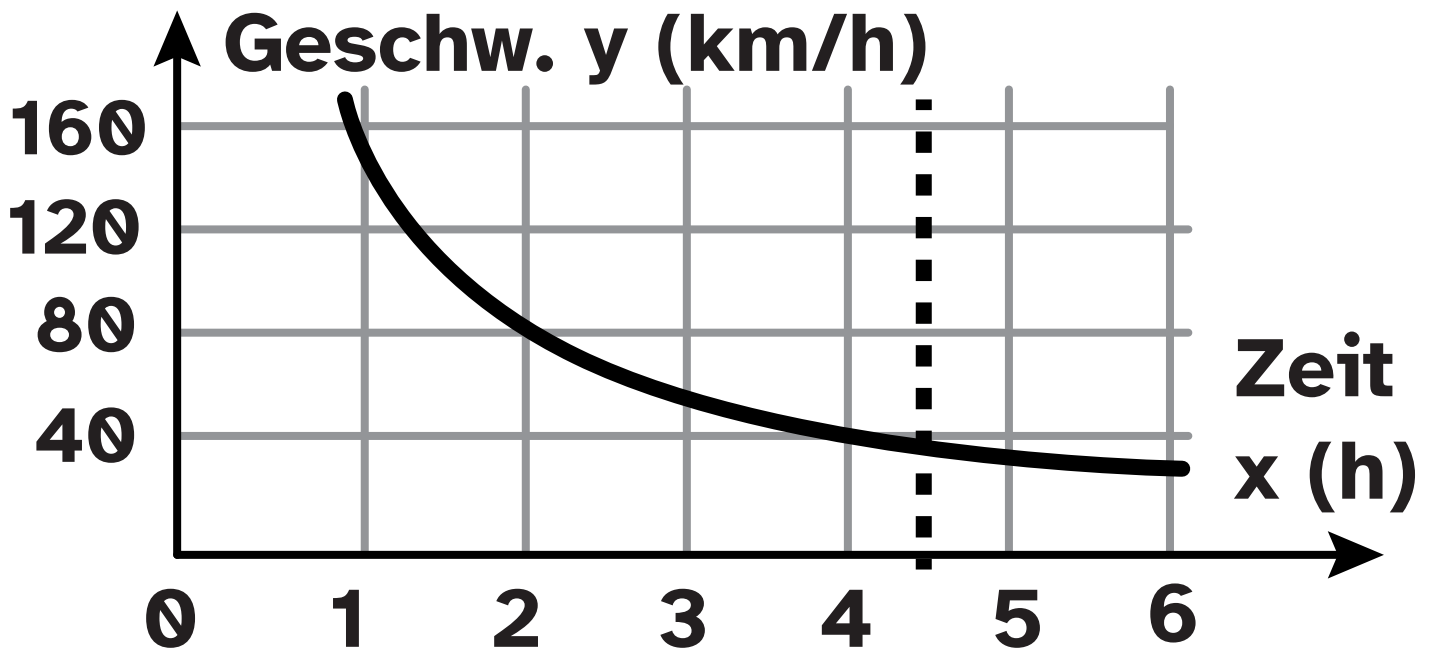
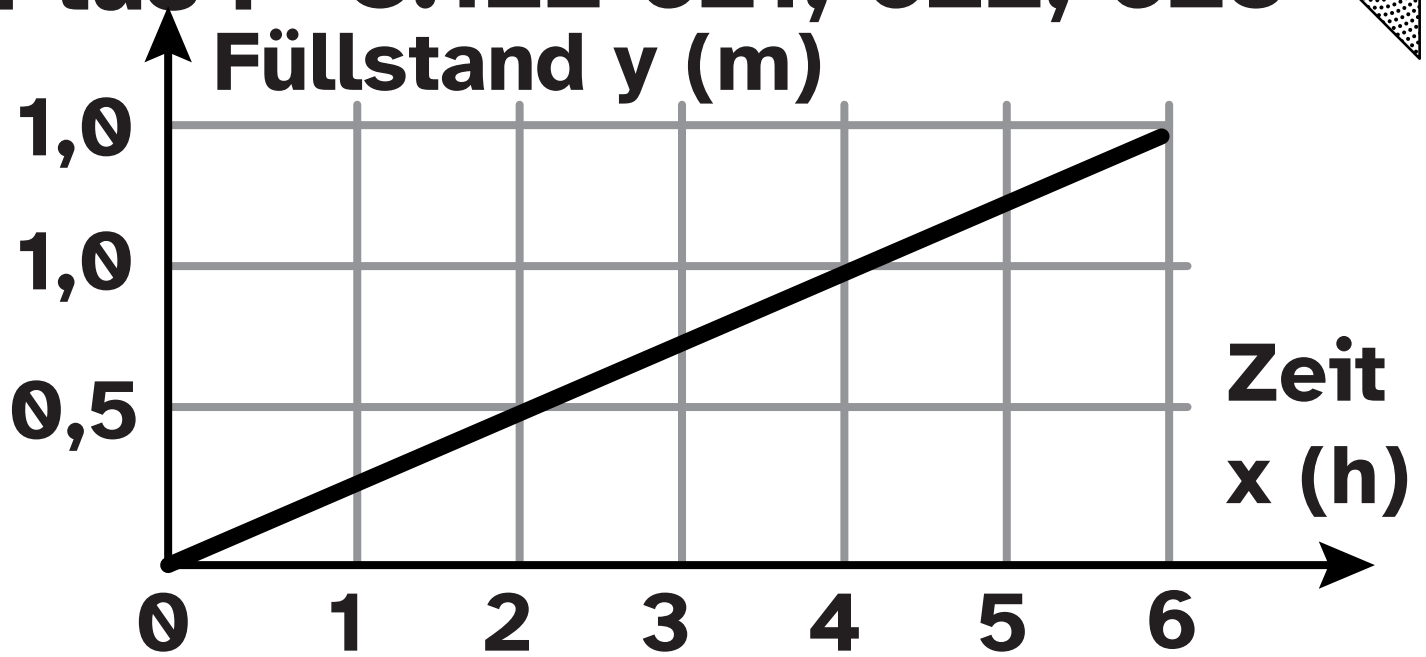
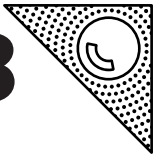

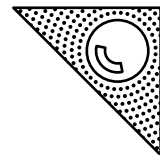

a)

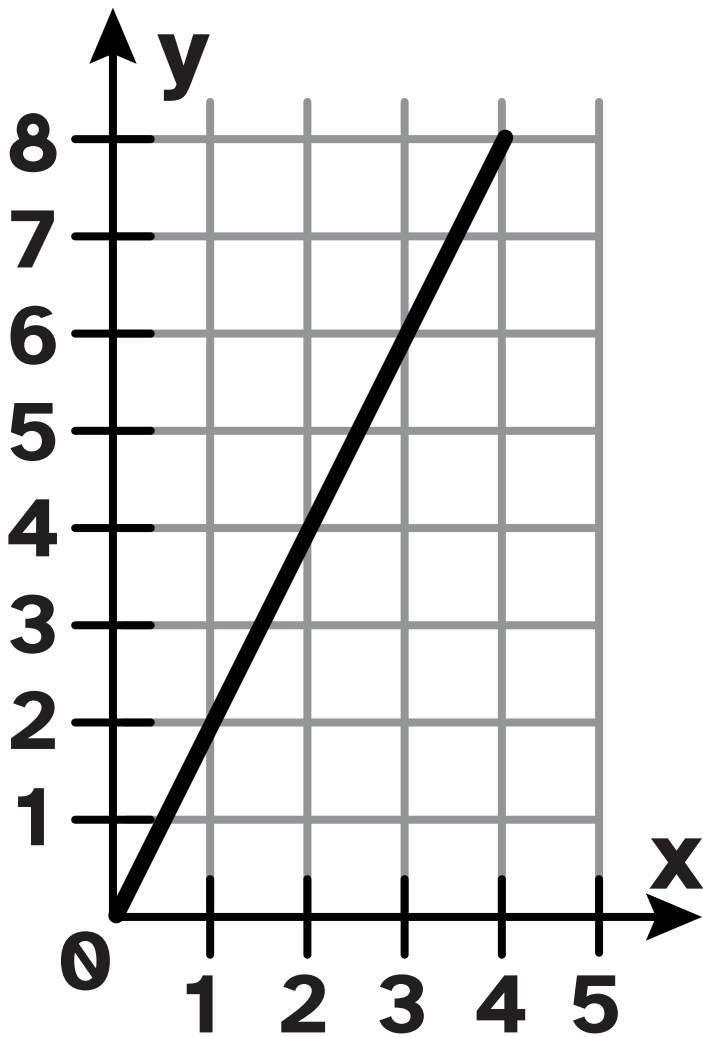

b)

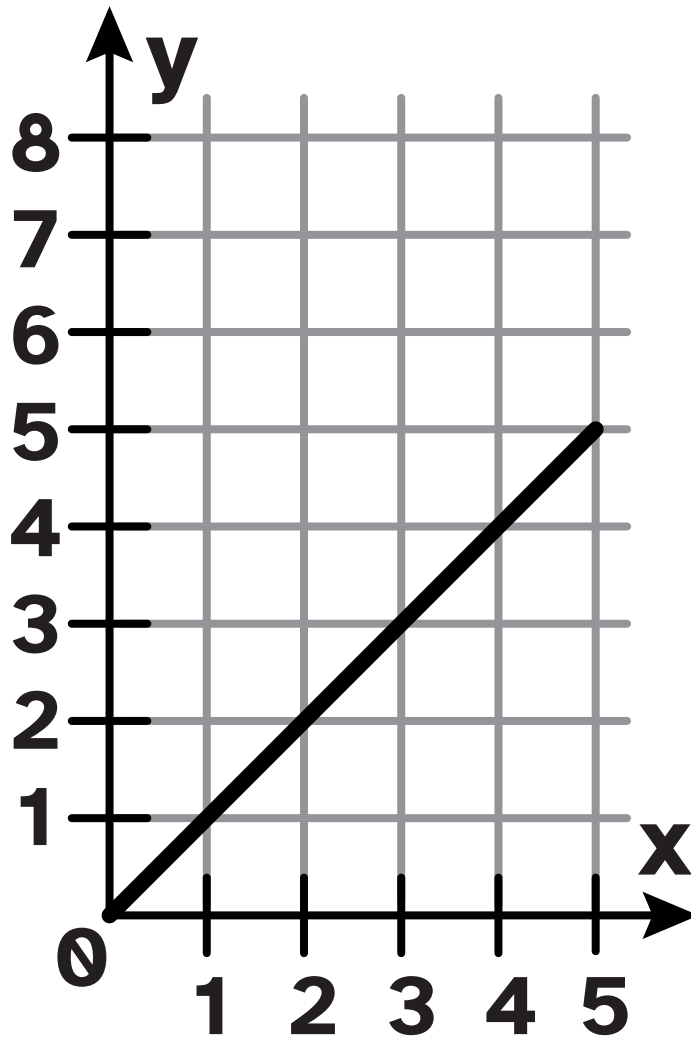

c)

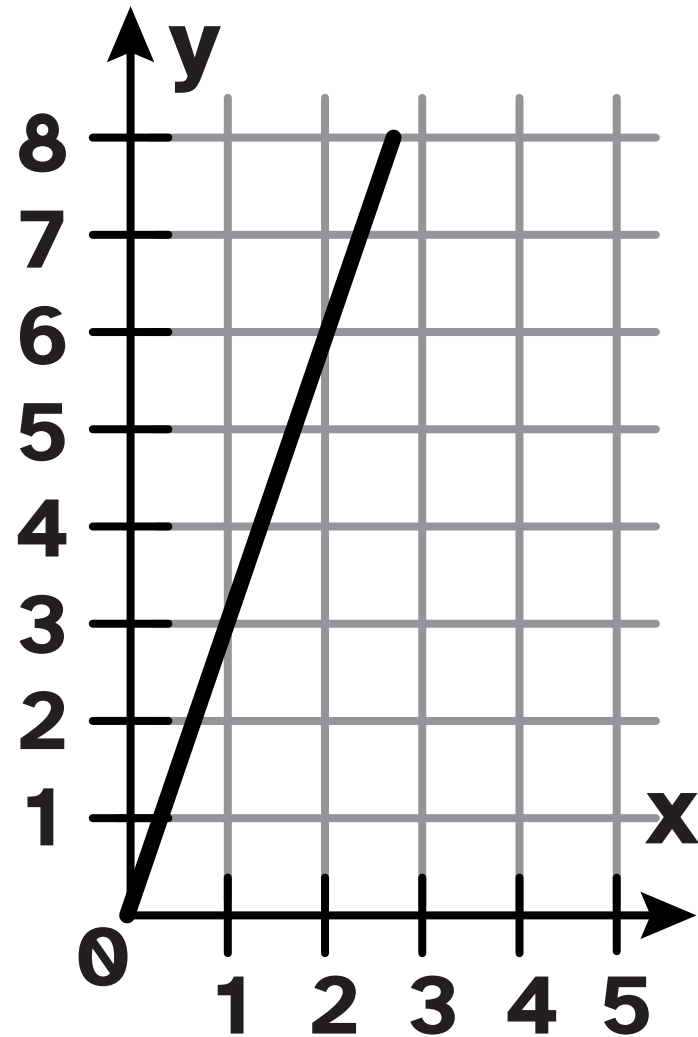



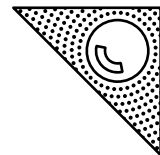

a)

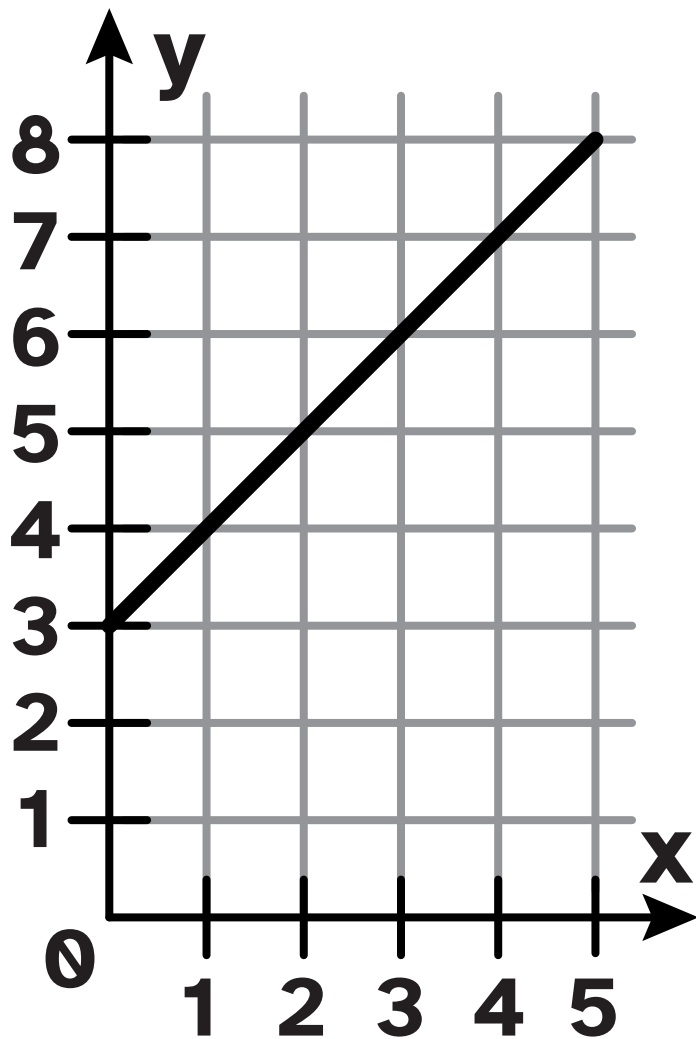

b)

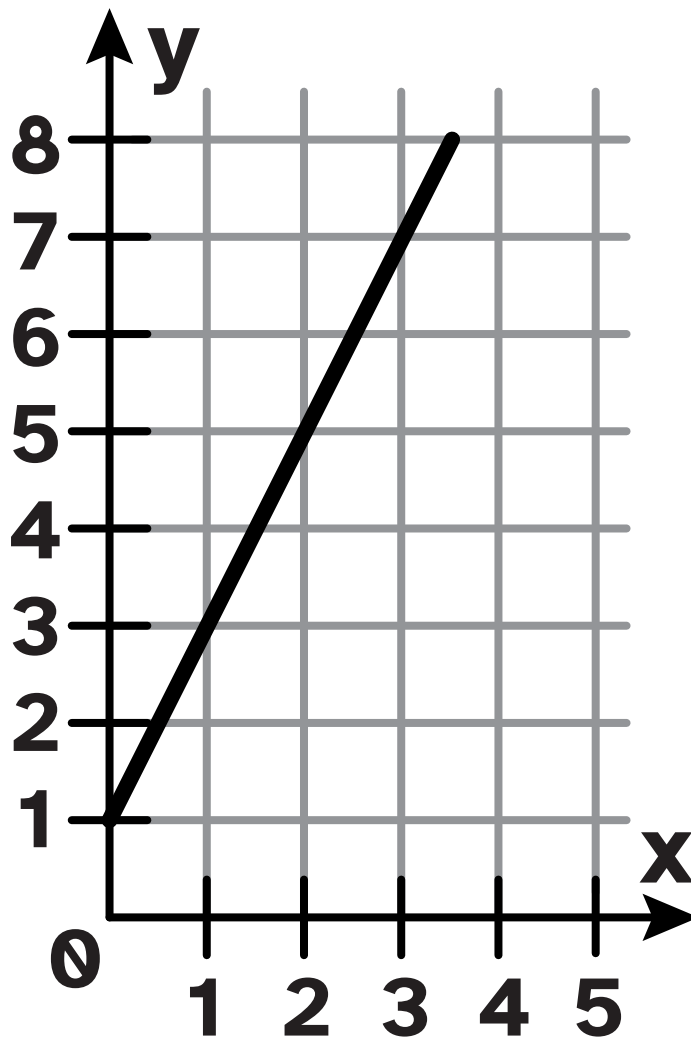

c)

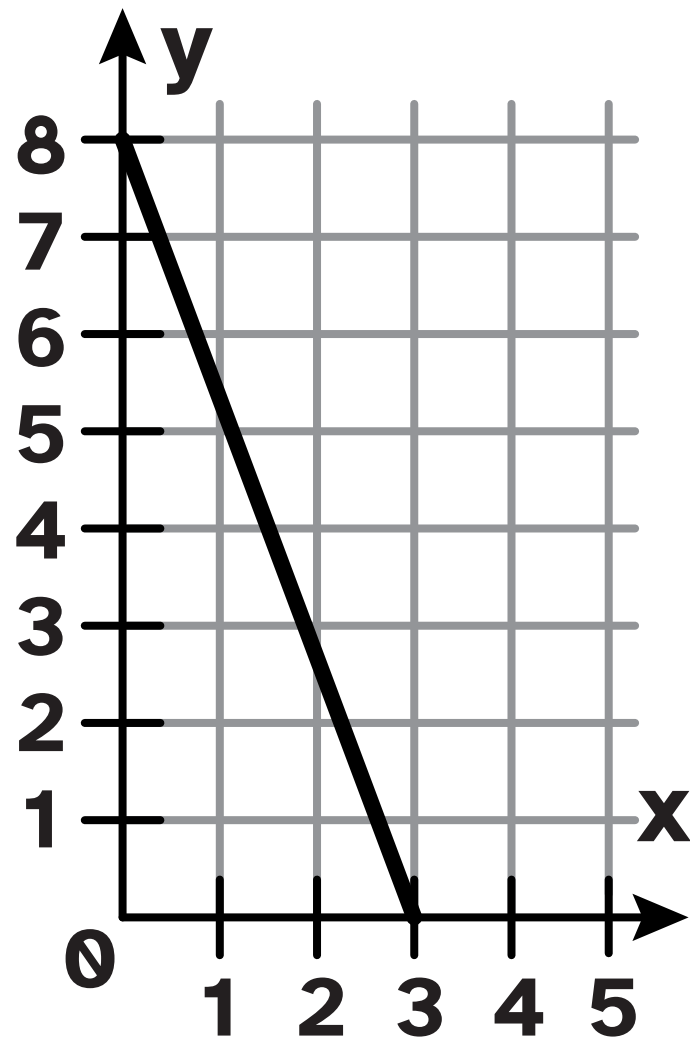

# Plus4

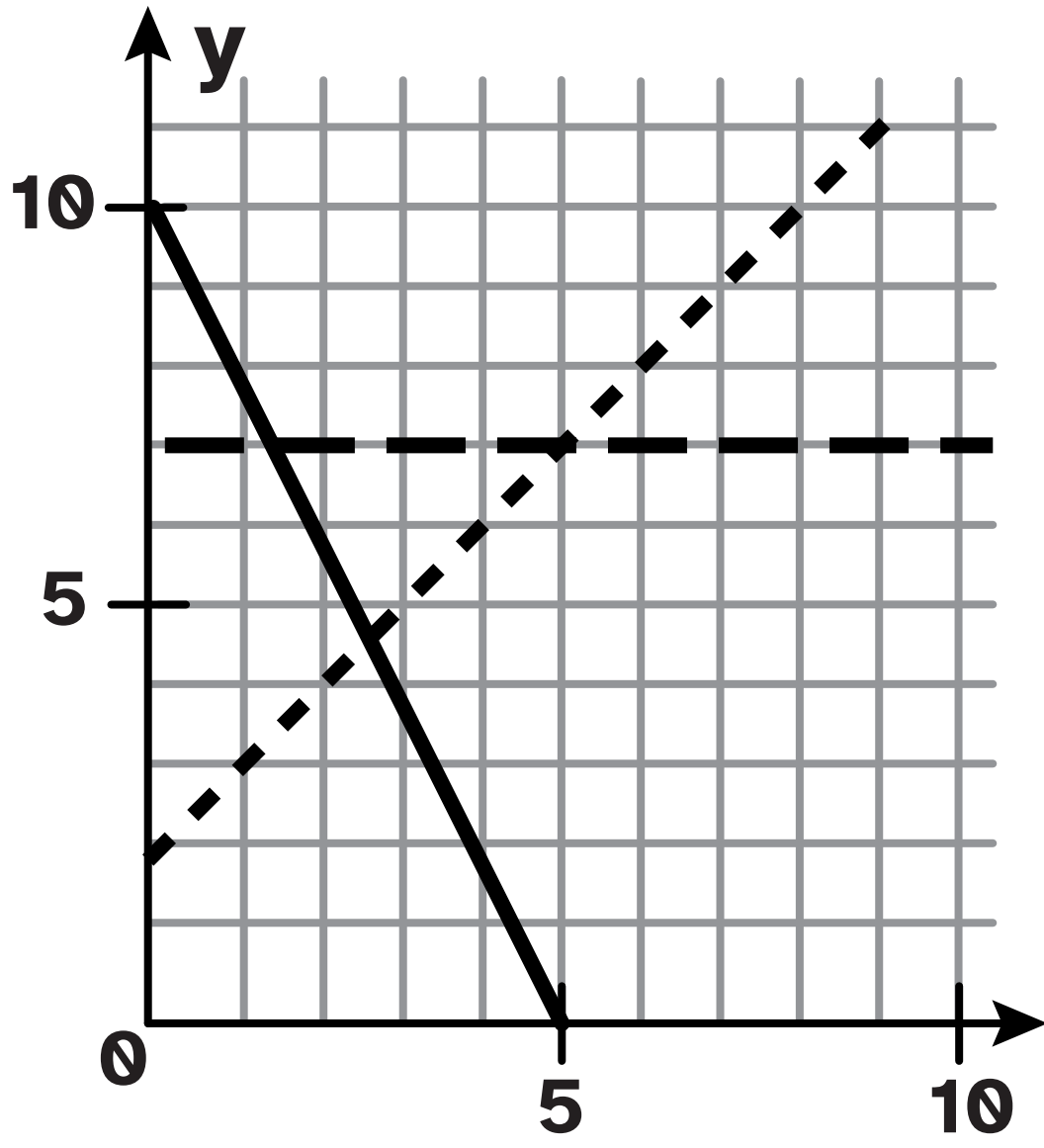

a) ——— b) - - - - c) - . - .

# S.125 632

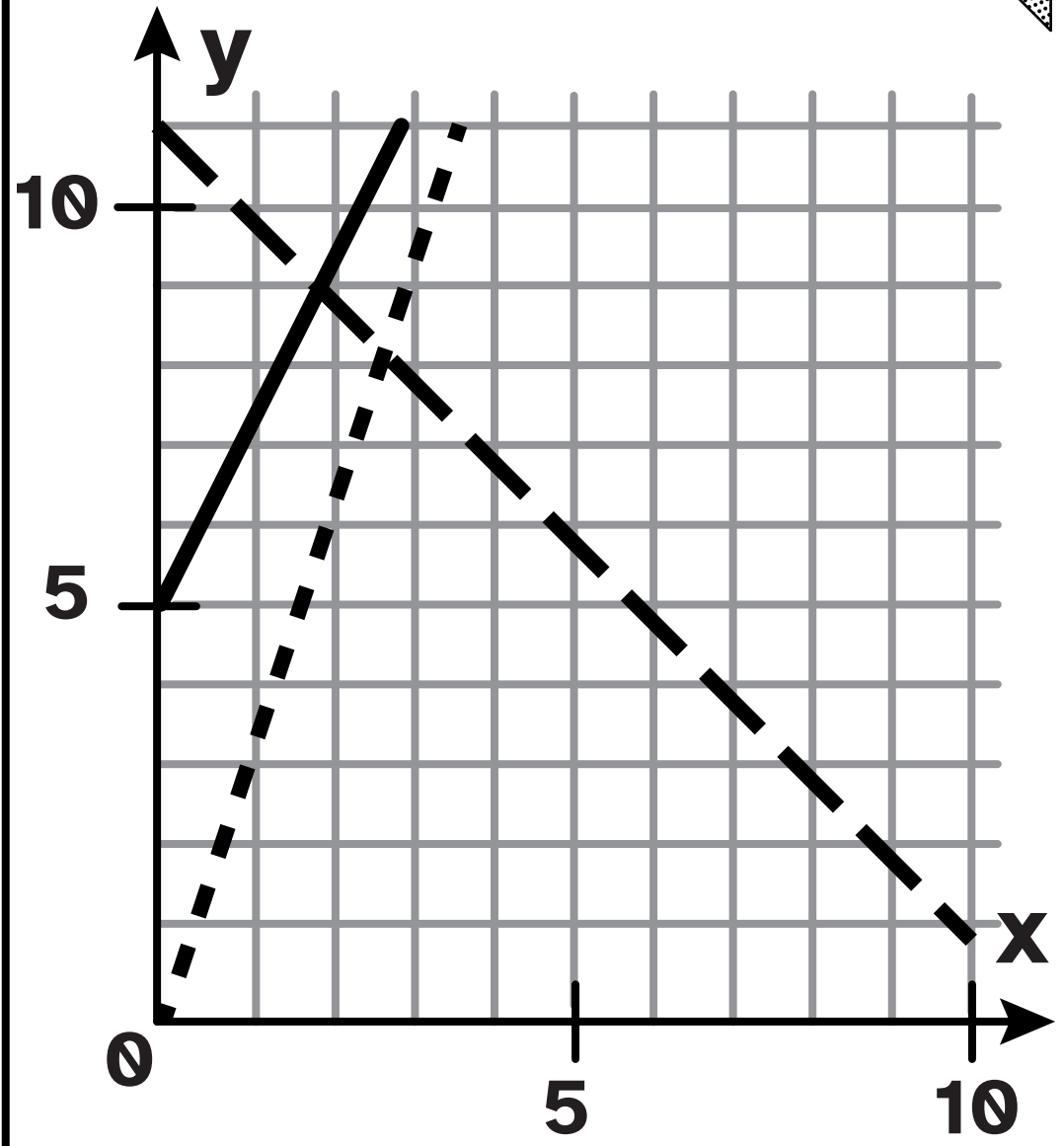
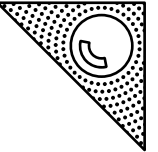

d) ——— e) - - - - f) - . - .

**Plus4**

**S.126 635**

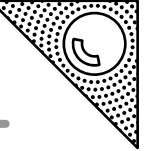

**y**

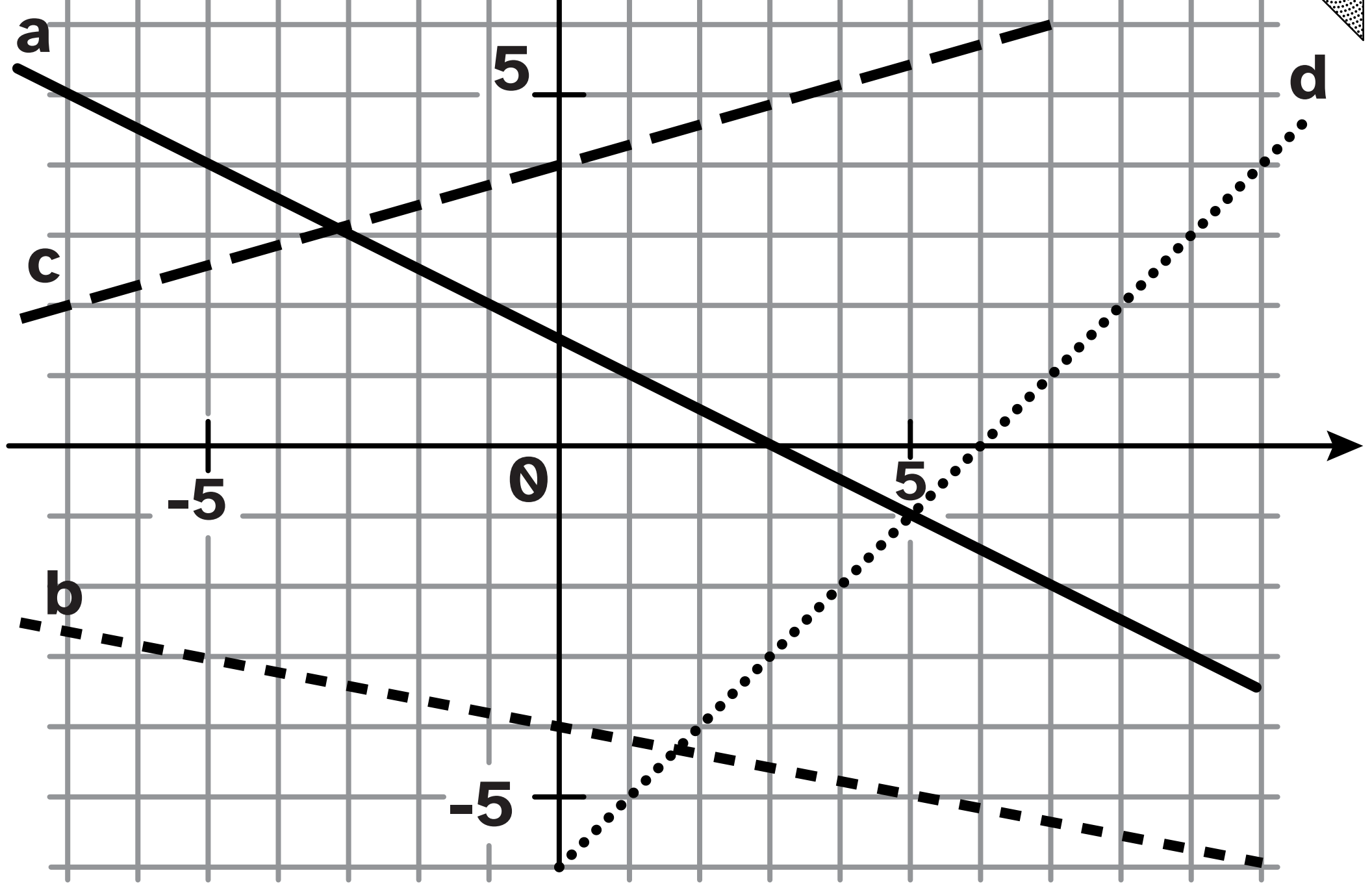

**a**

**5**

**d**

**c**

**-5**

**0**

**5**

**b**

**-5**

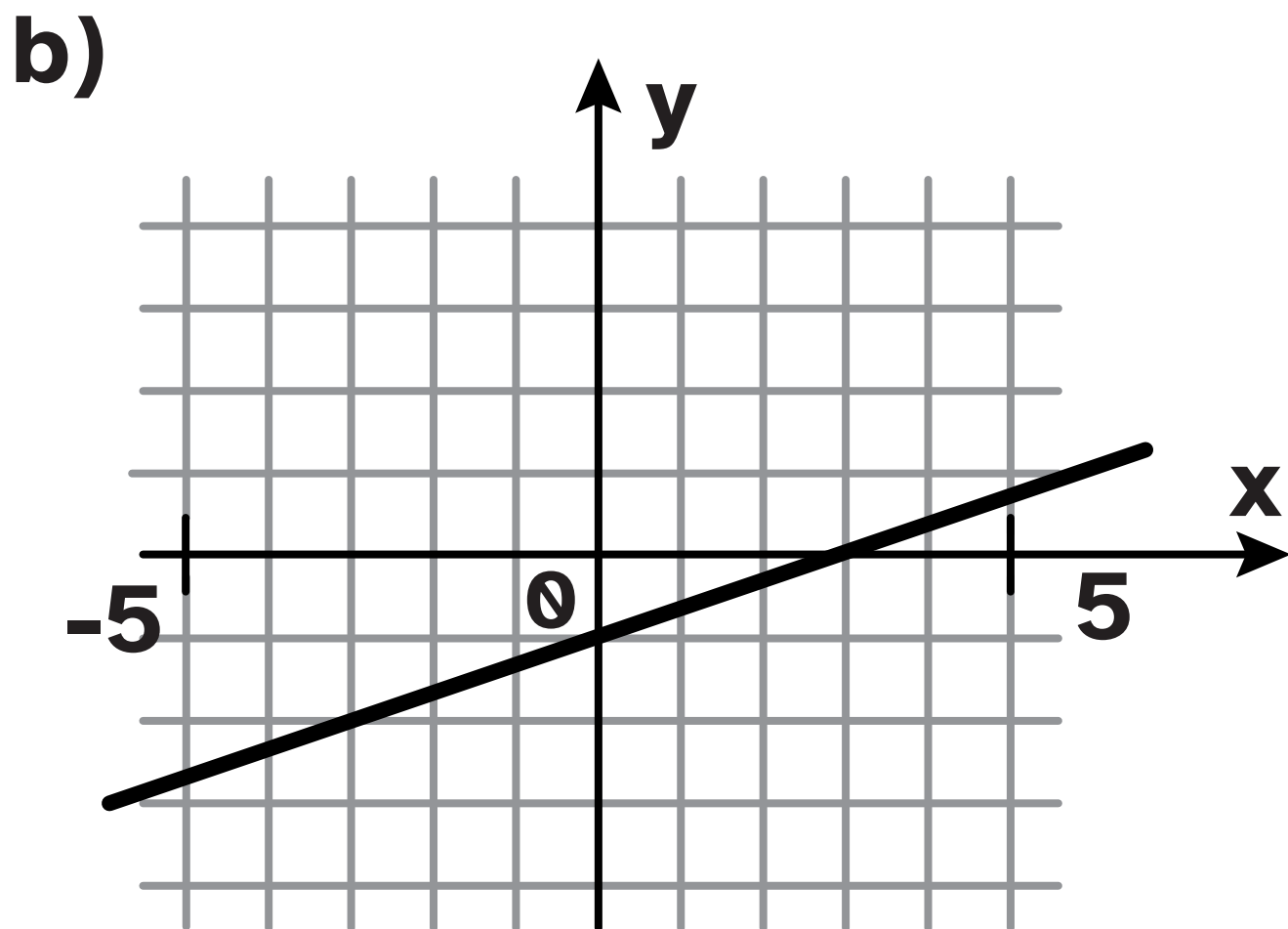
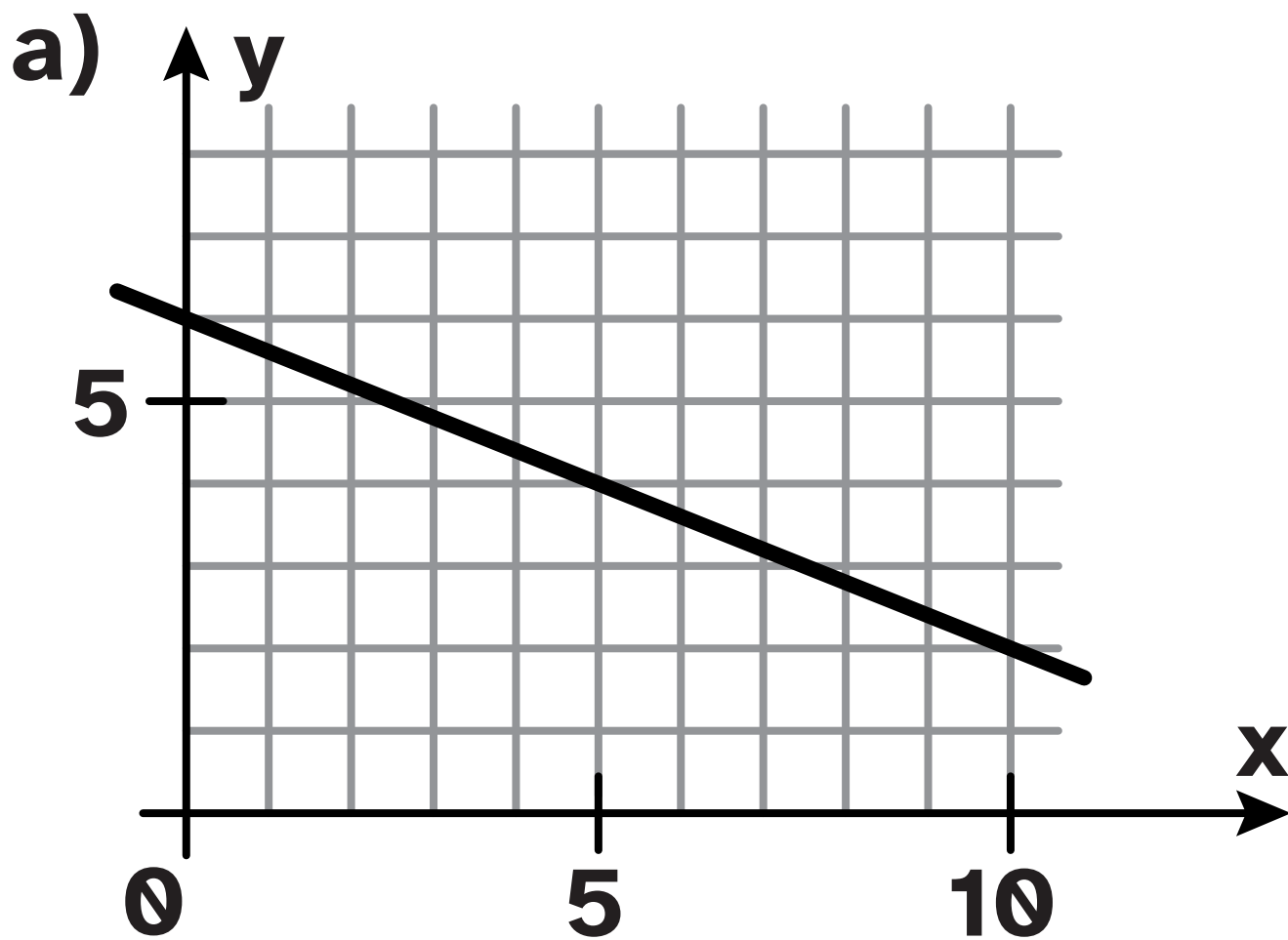
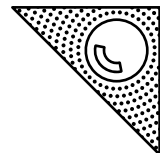

Plus4 y (cm)

S.128 643

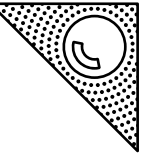

15

10

5

0

5

10

15

20

x (cm)

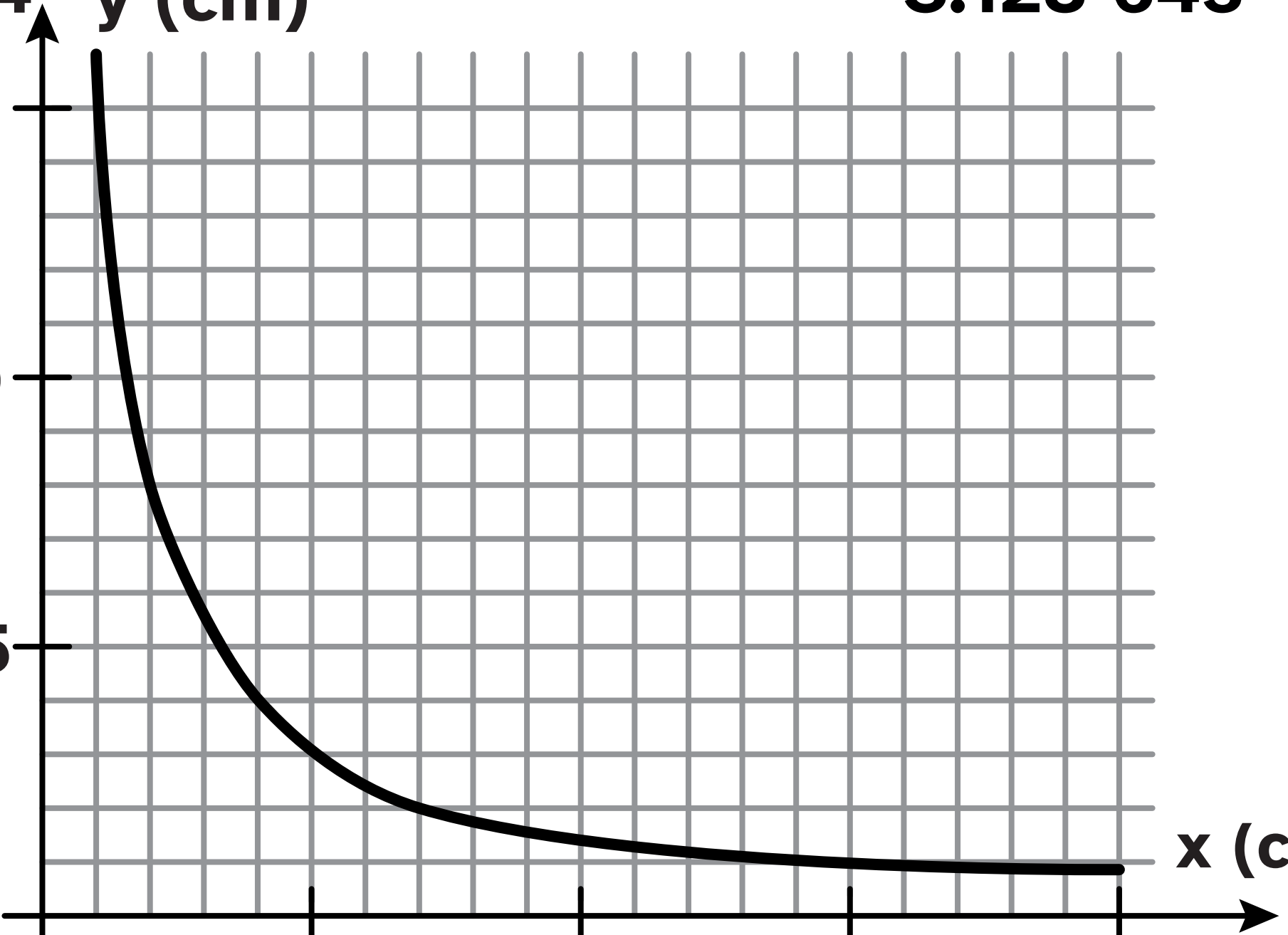

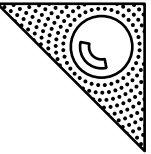

# mittlere Geschwindigkeit

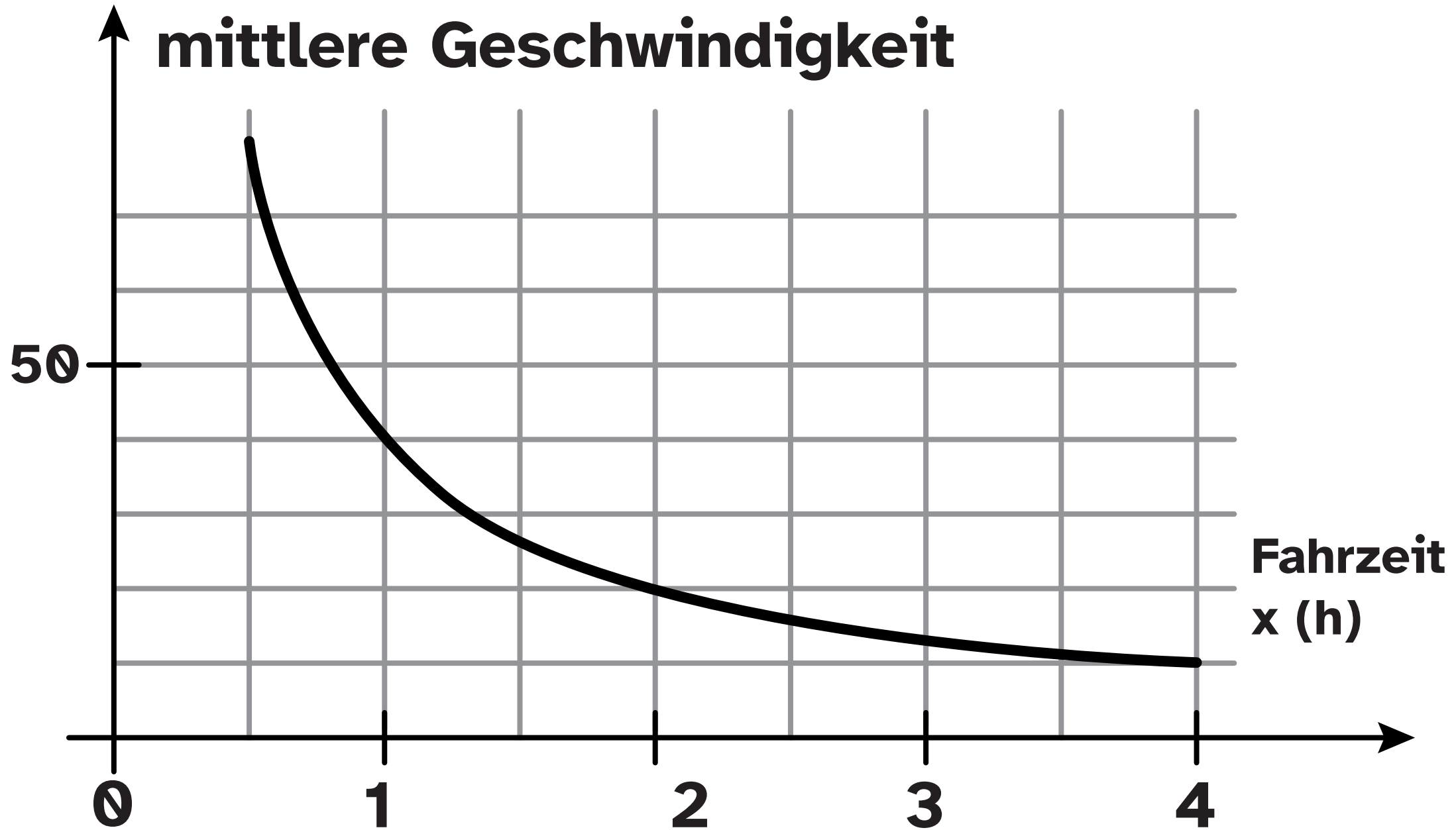

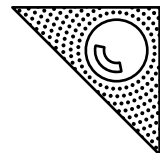

a)

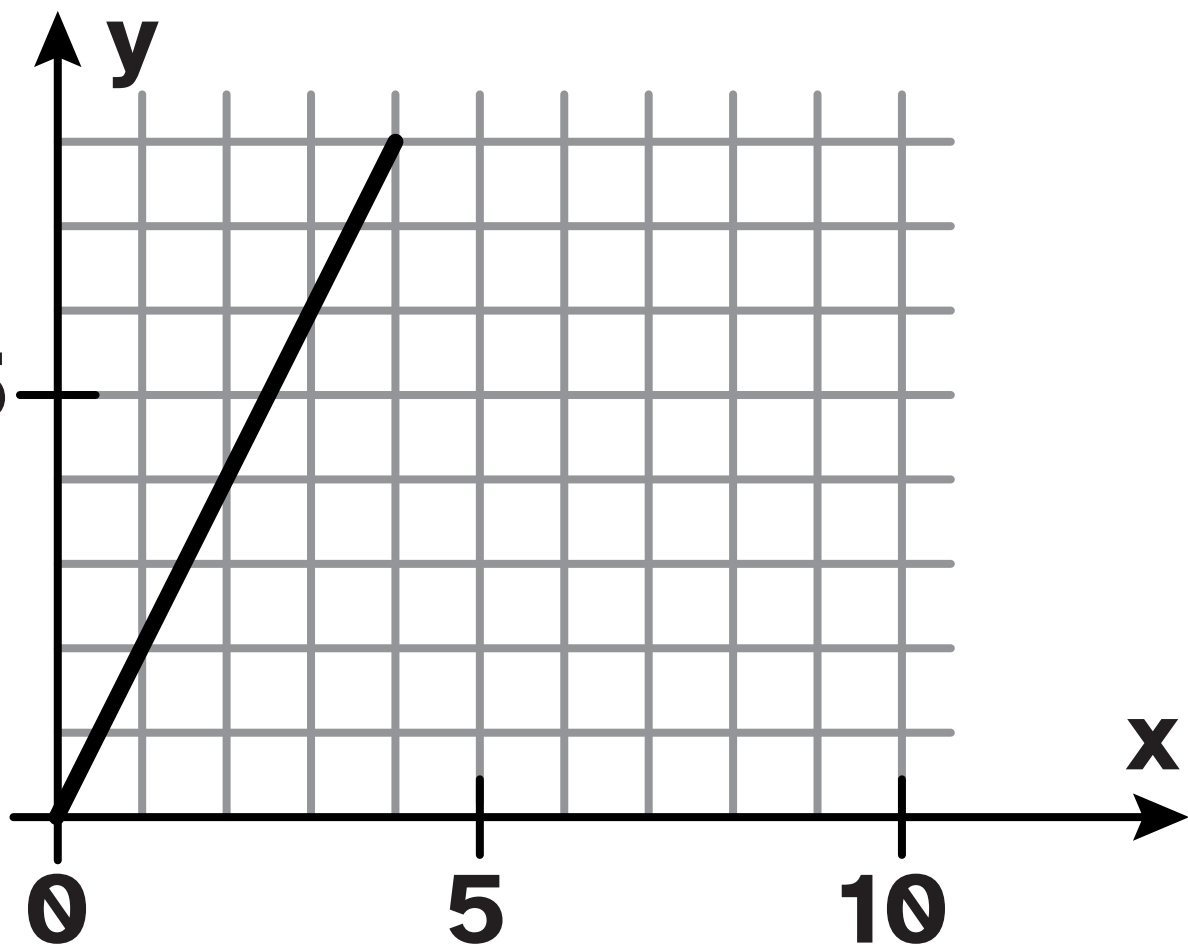

b)

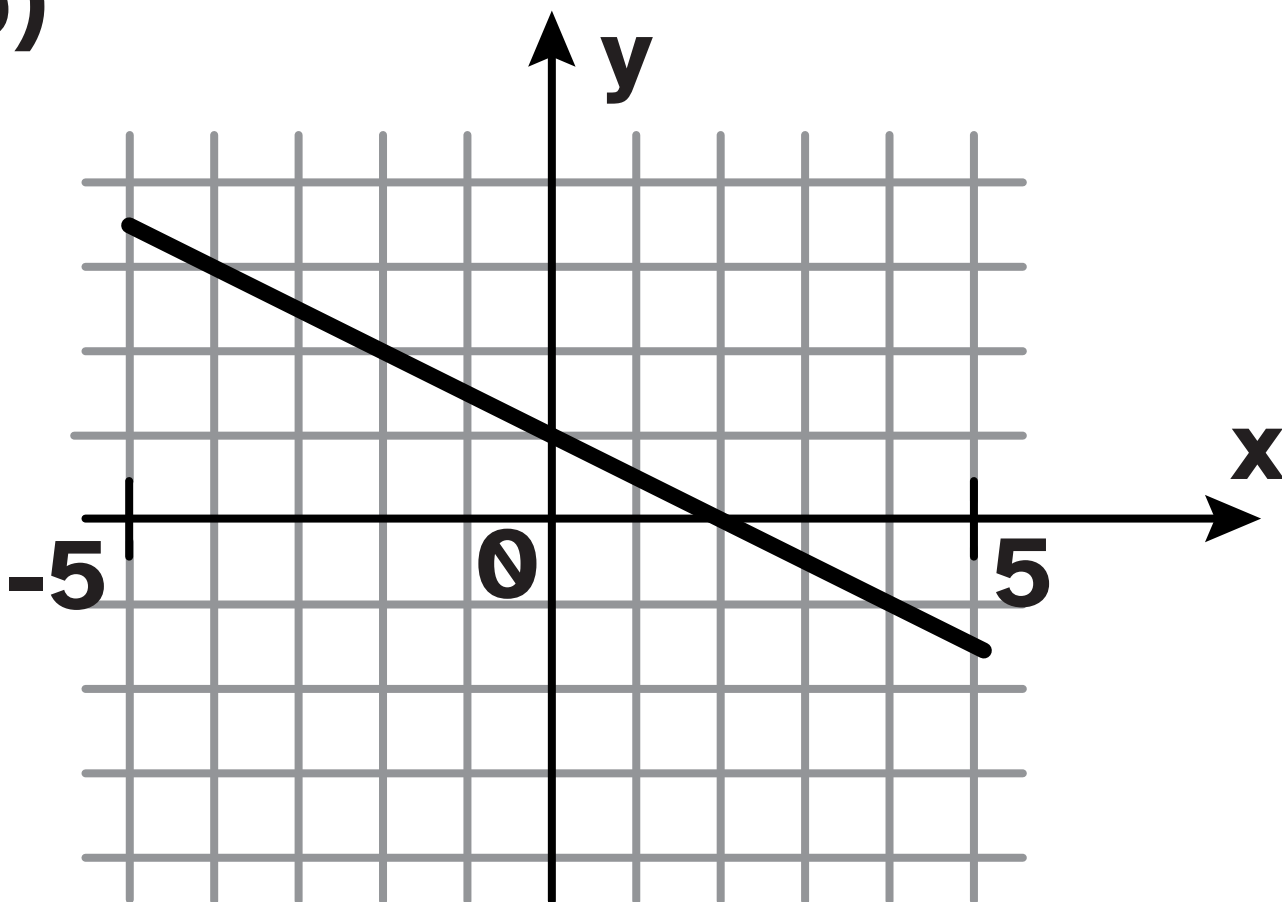

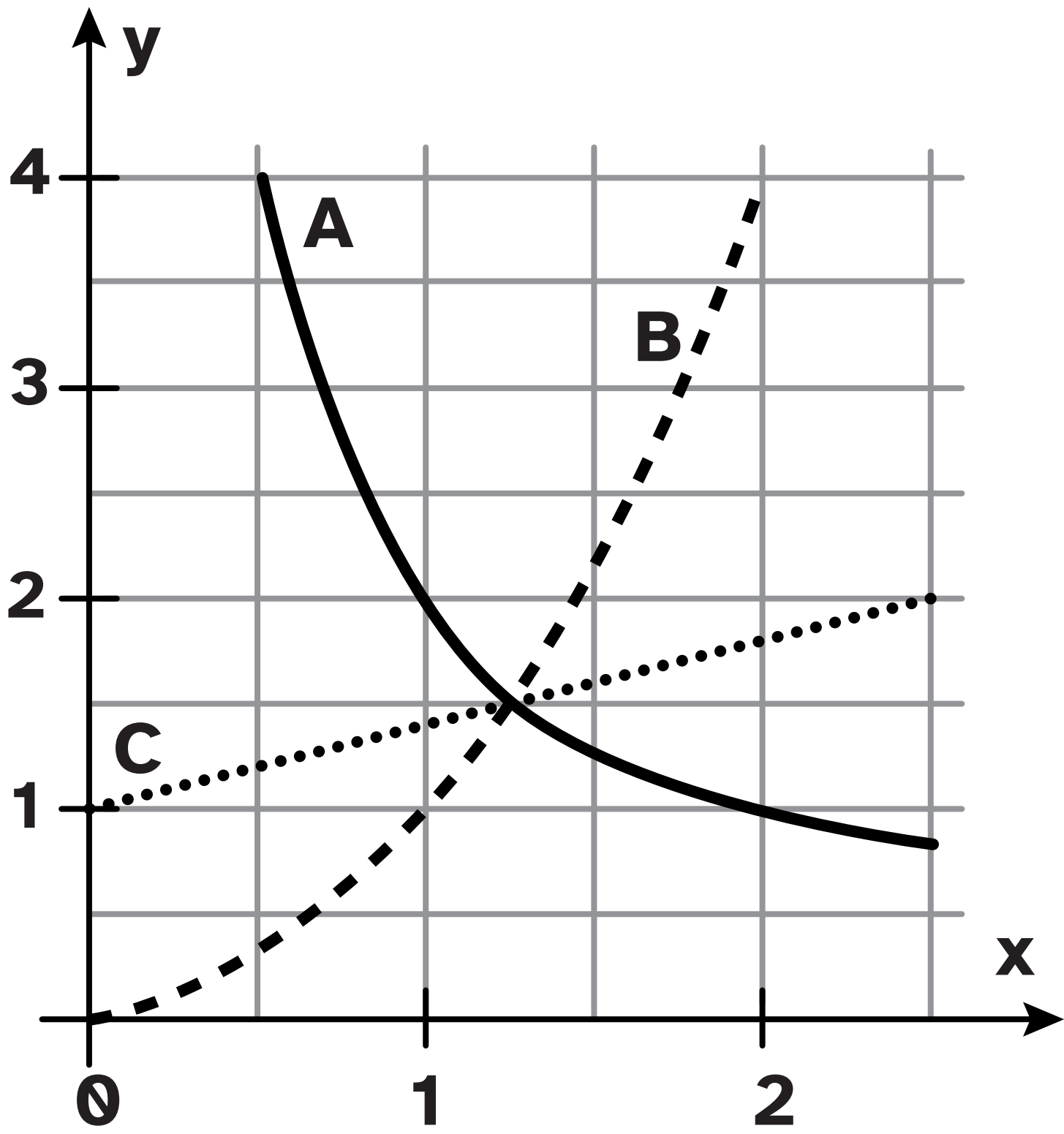
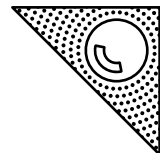



# Plus4

# S.132 658

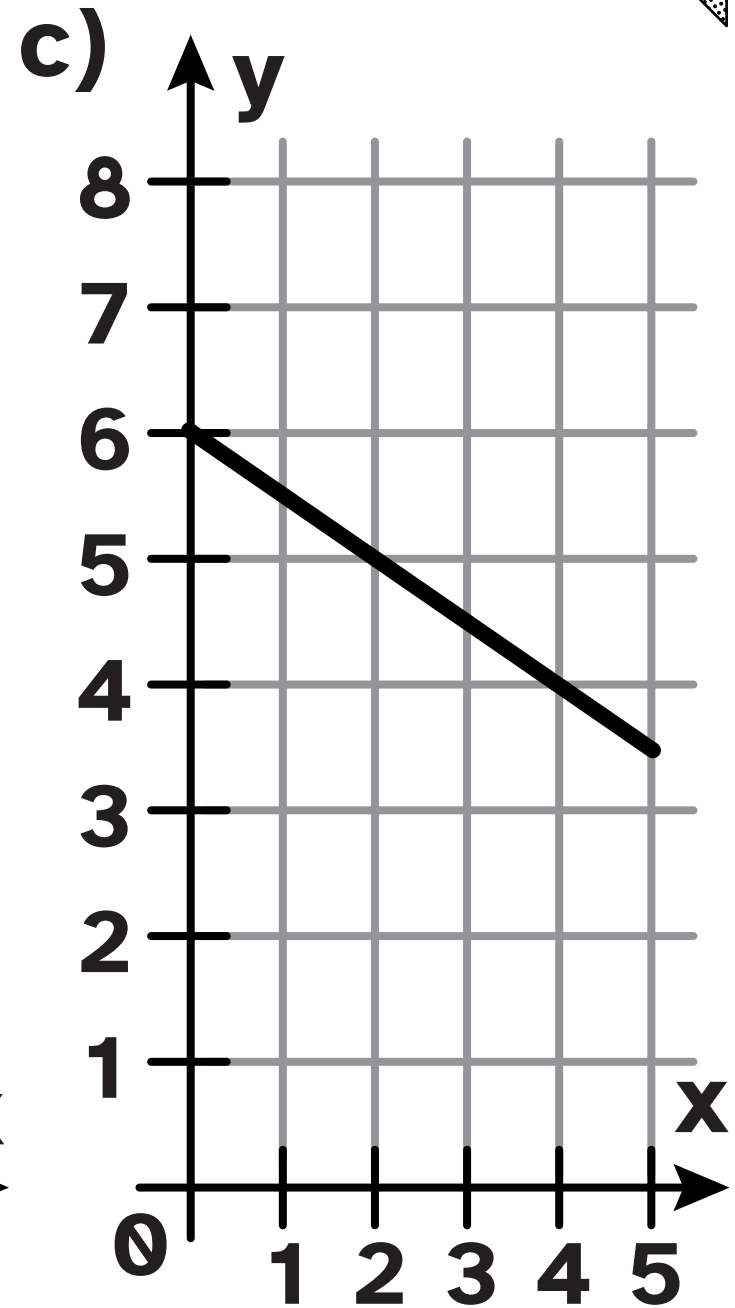
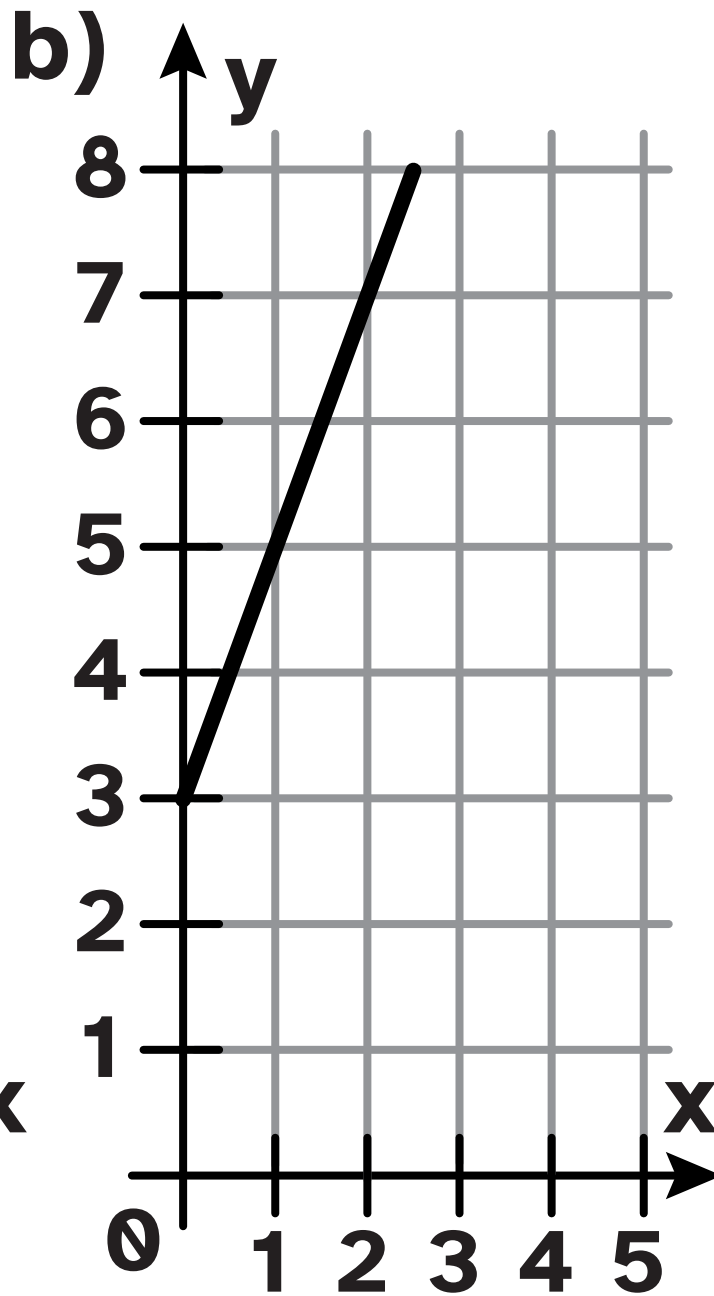
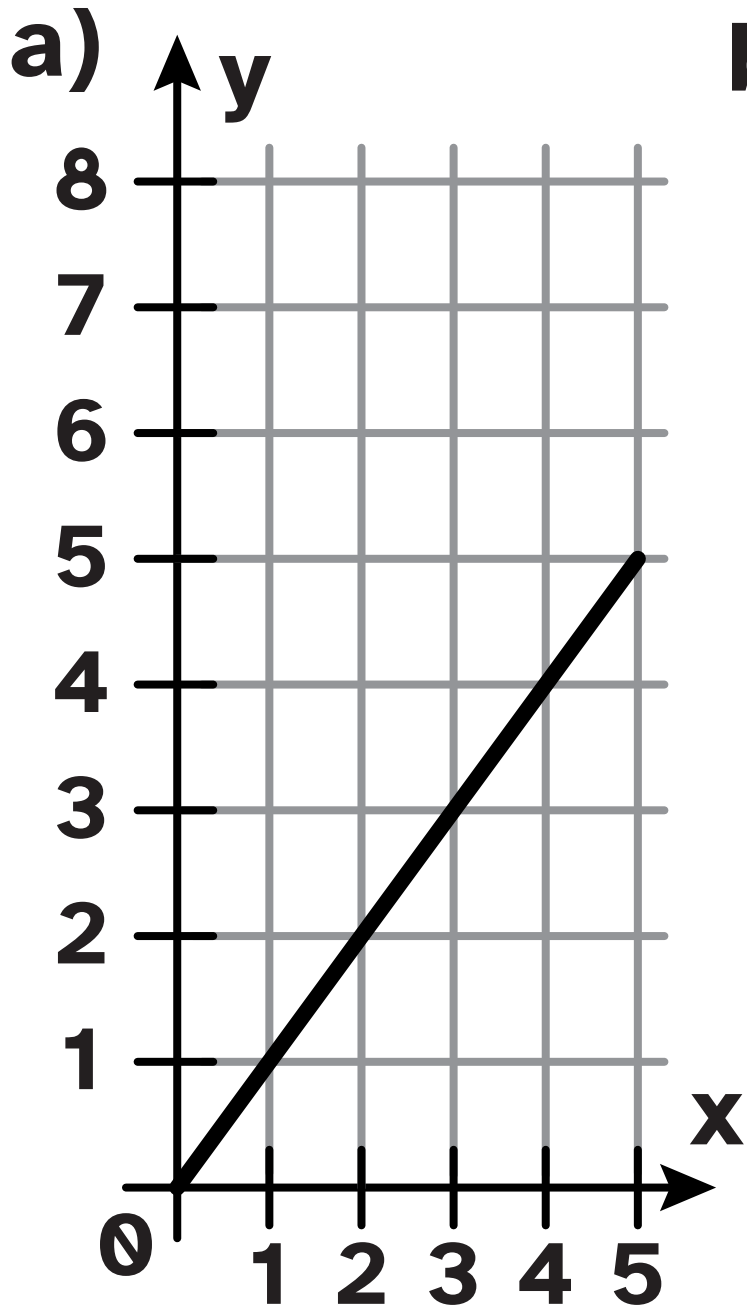
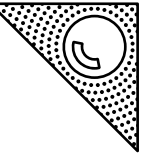

Plus4

S.133 661

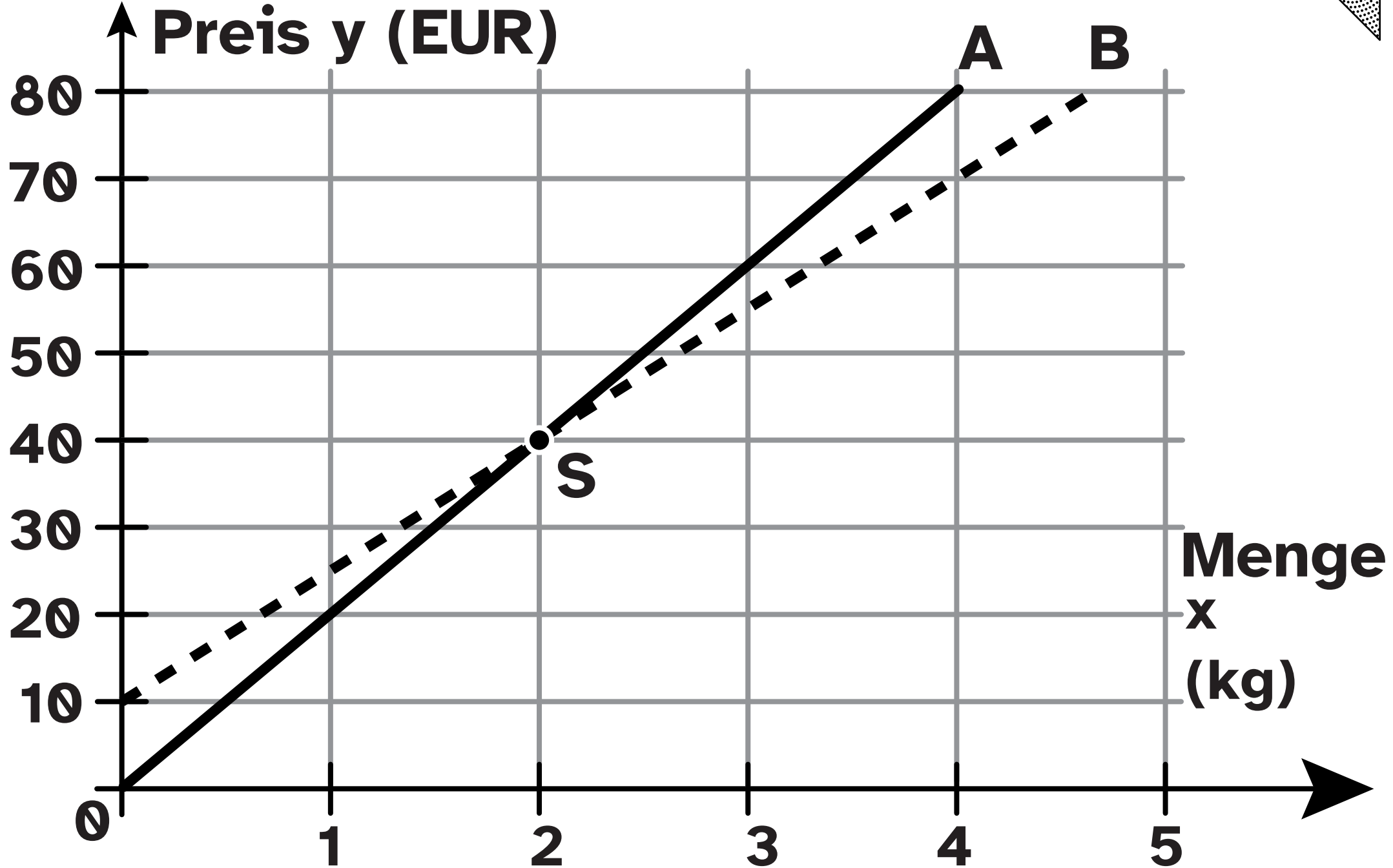
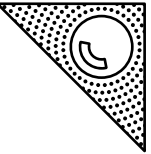

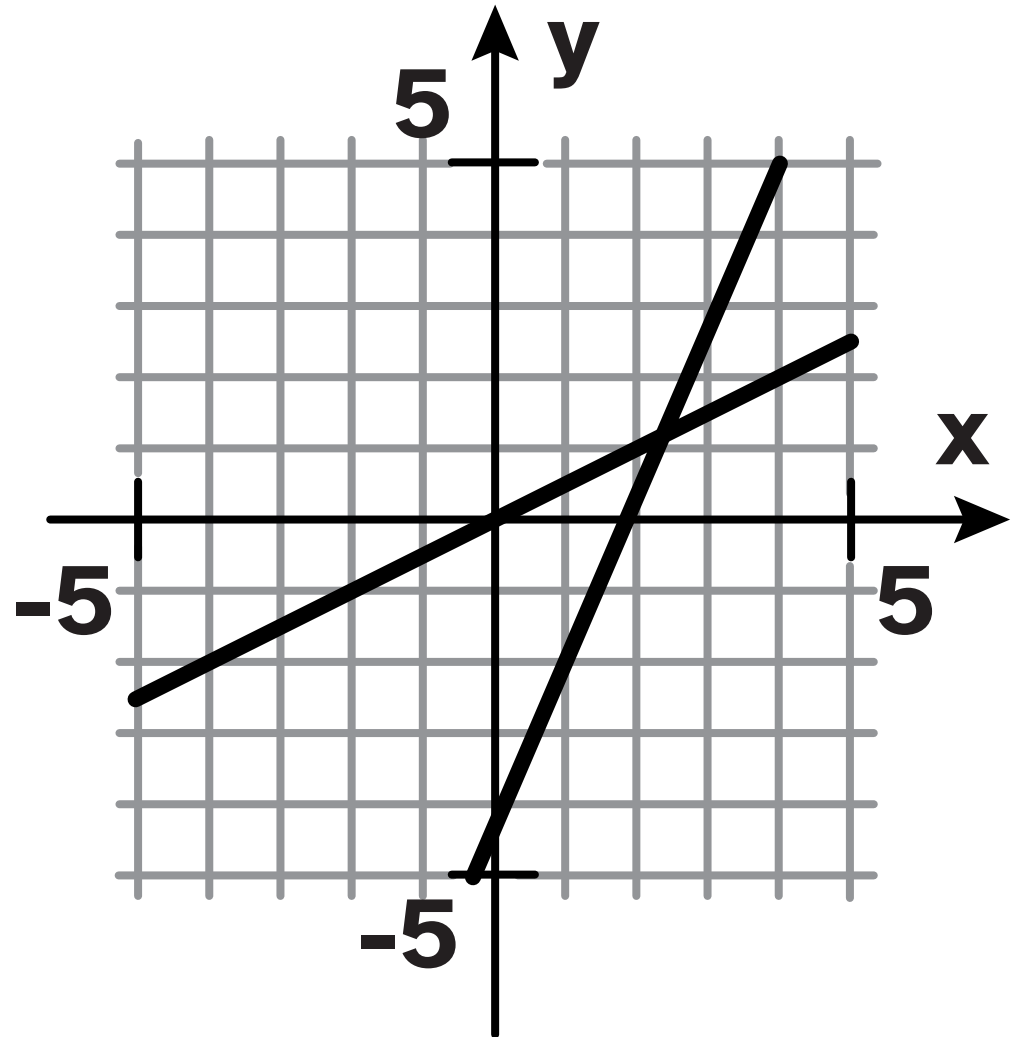
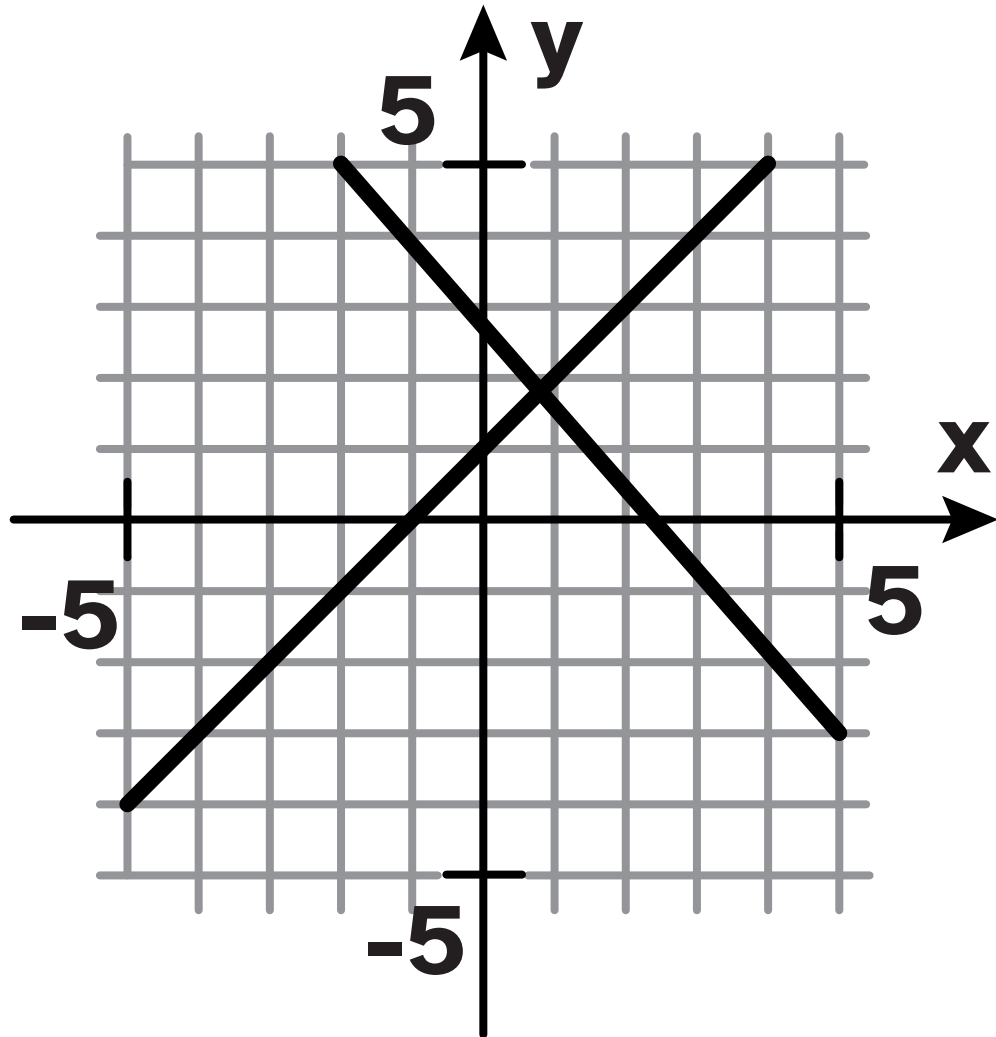
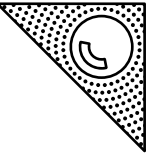

Plus4

S.134 663, 664 a

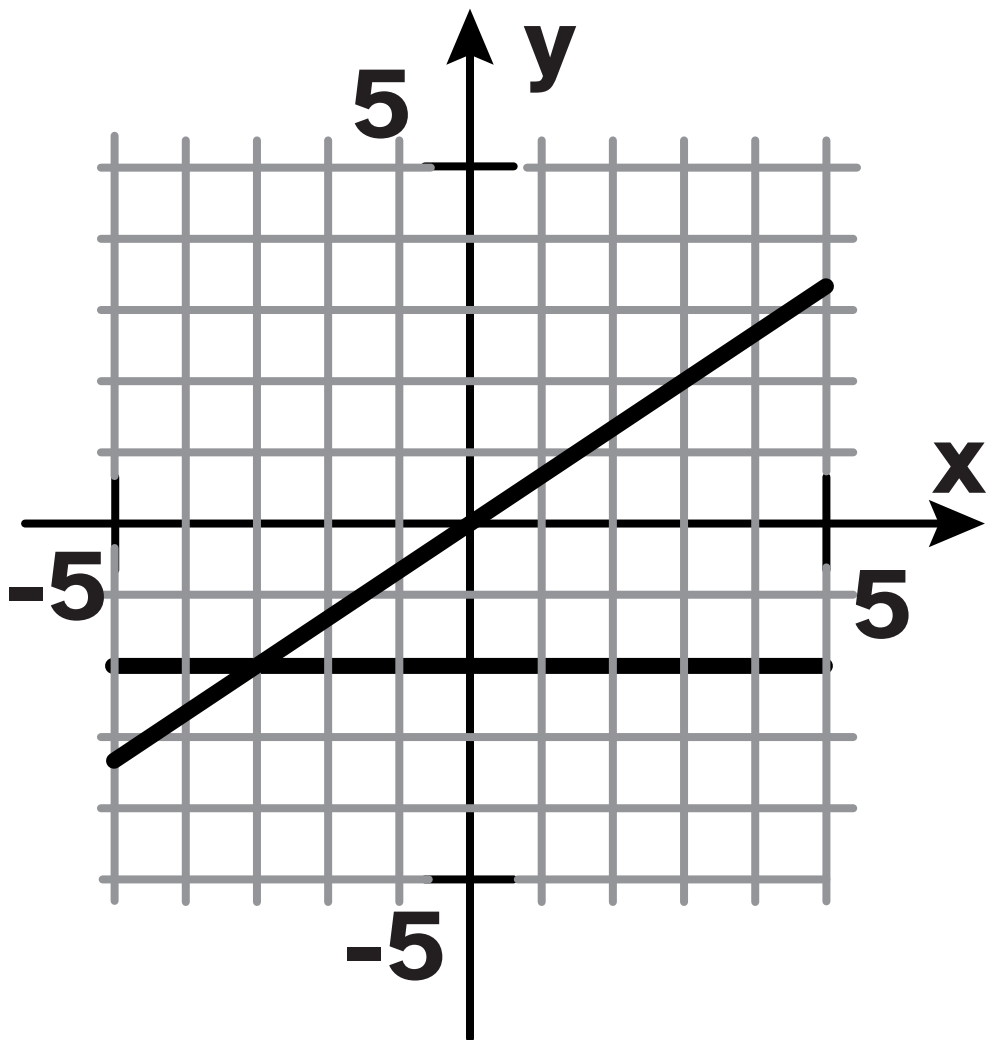
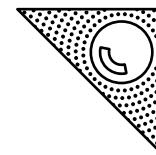

a)

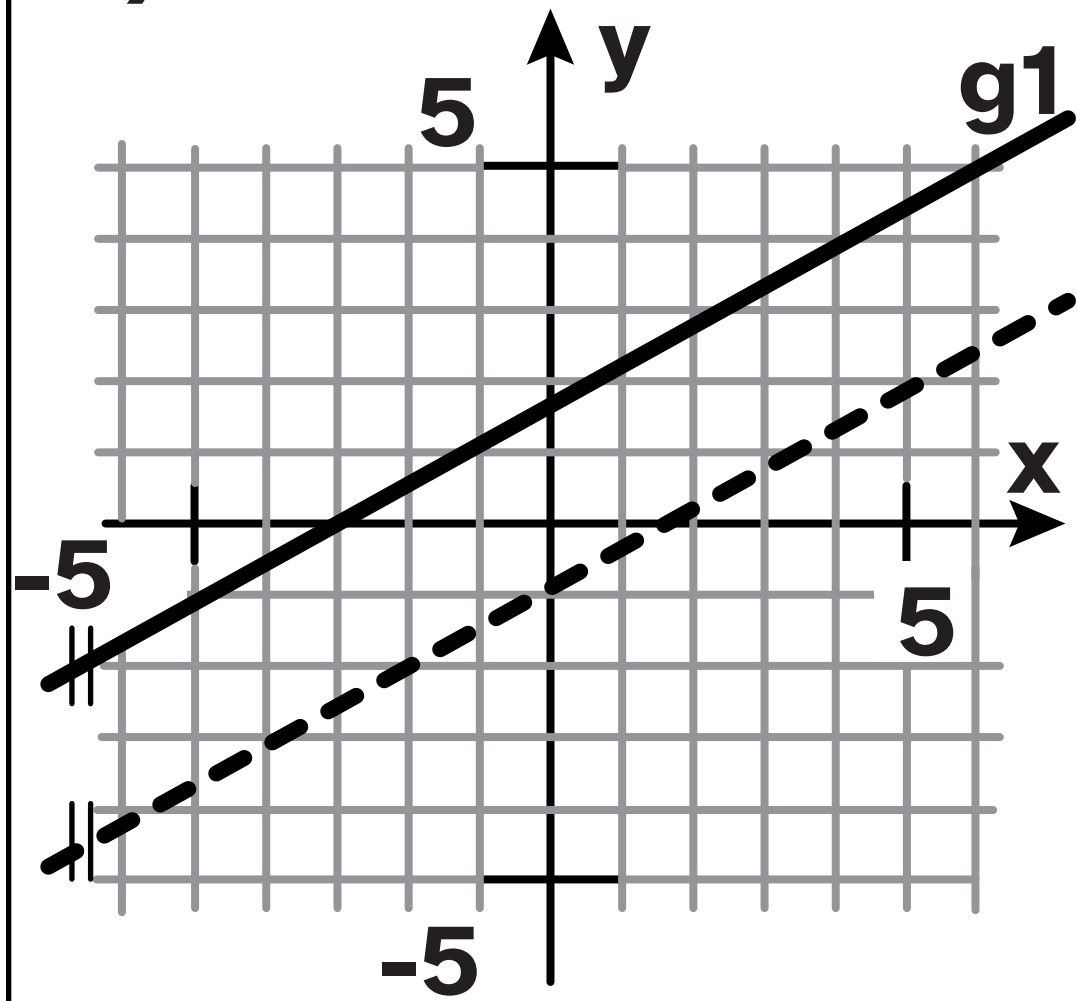

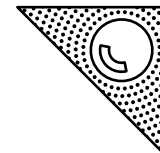

b)

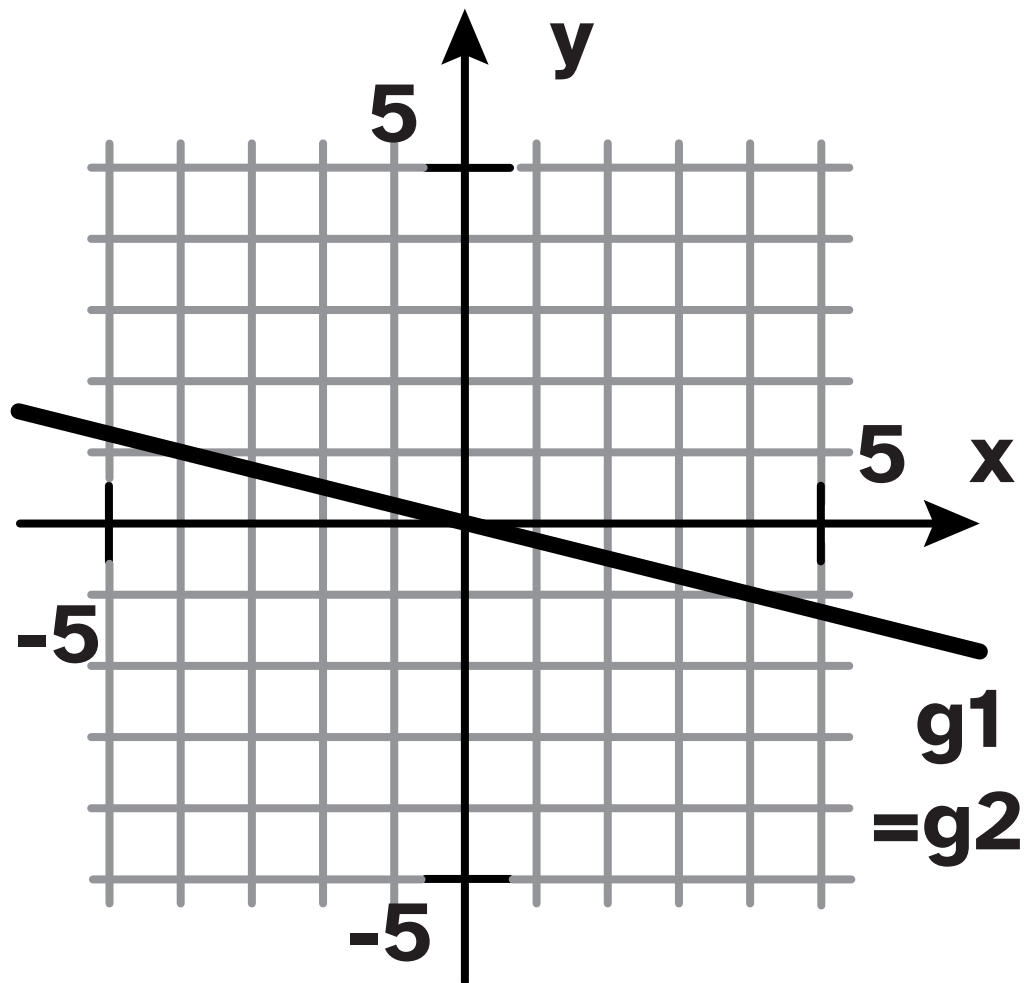

c)

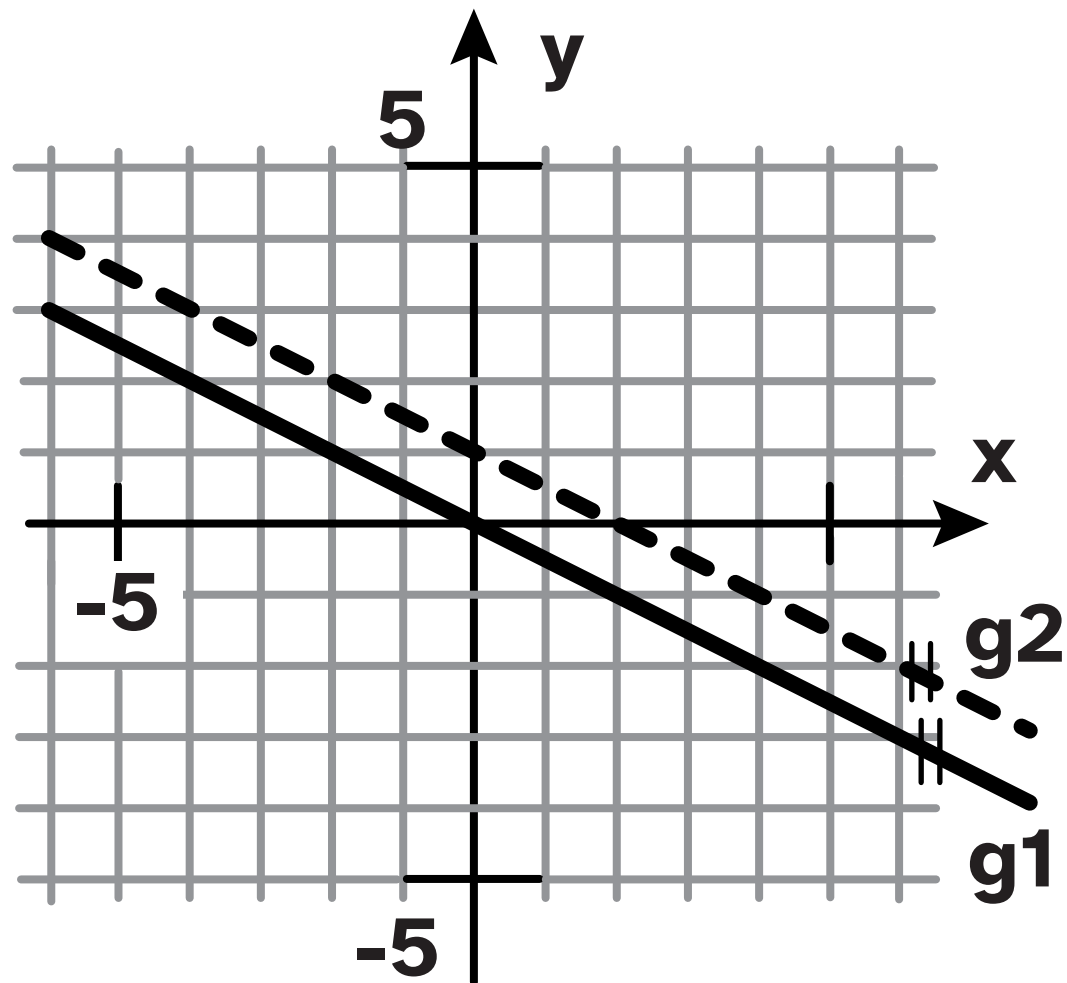

**Plus4**

**S.142 705**

