

Kontoauszug (EURO)

Datum	Ausgänge	Eingänge
05.03	737,00 -	
06.03	350,00 -	
10.03		1245,00 +
10.03		82,00 +
16.03	578,00 -	
22.03		564,00 +
23.03		200,00 +
Alter Kontostand		163,00 +
Summe Ausgänge		1665,00 -
Summe Eingänge		2091,00 +
Neuer Kontostand		589,00 +

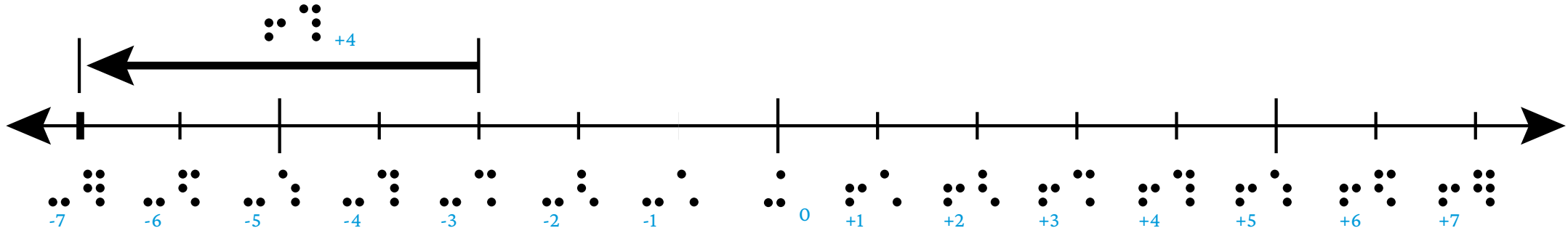

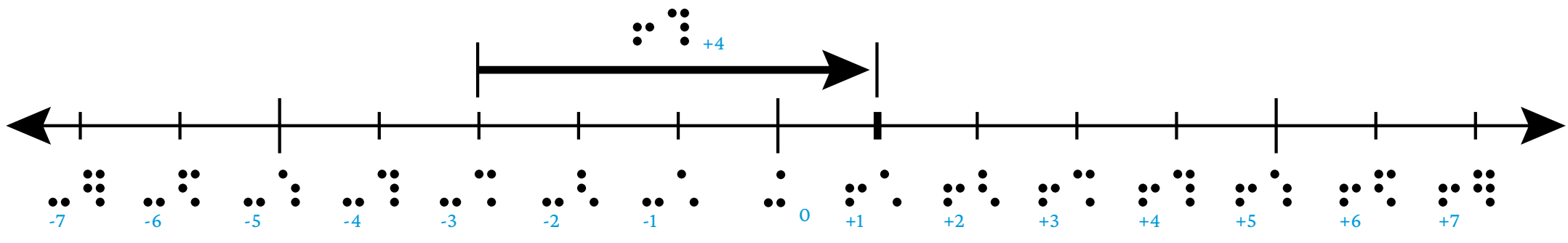
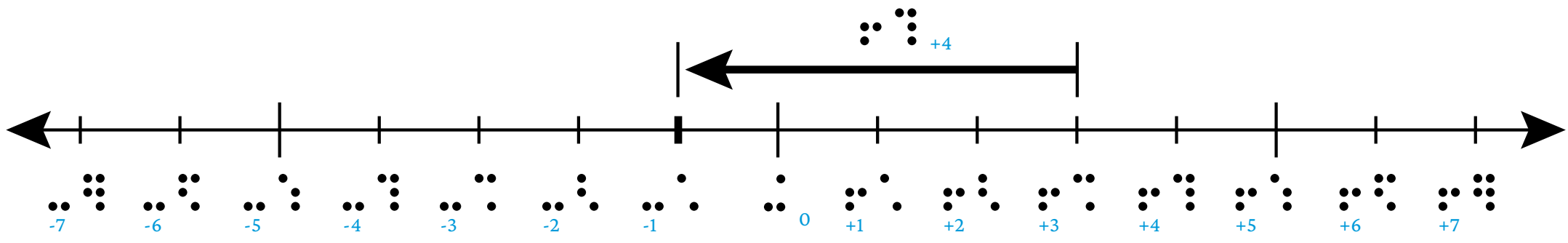
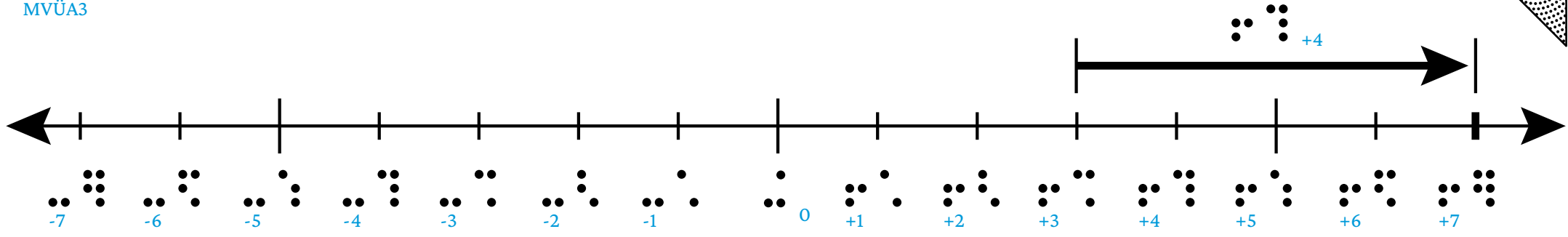
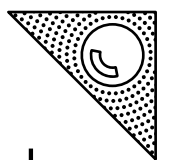
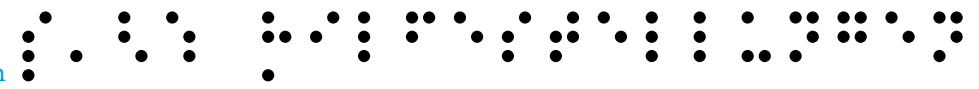
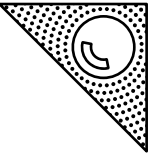

Braille text: "Quadrieren"

Quadrieren

Braille text: "Flächeninhalt eines Quadrats"

Flächeninhalt eines Quadrats

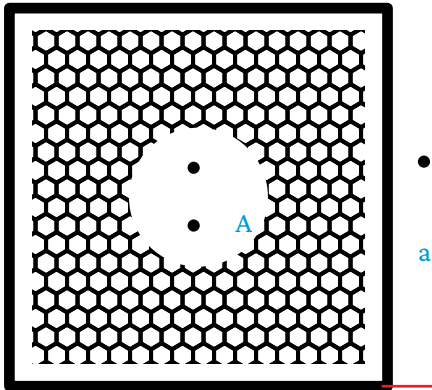

a

Braille text: $A = a * a = a^2$

$A = a * a = a^2$

Braille text: "Kubieren"

Kubieren

Braille text: "Volumen eines Würfels"

Volumen eines Würfels

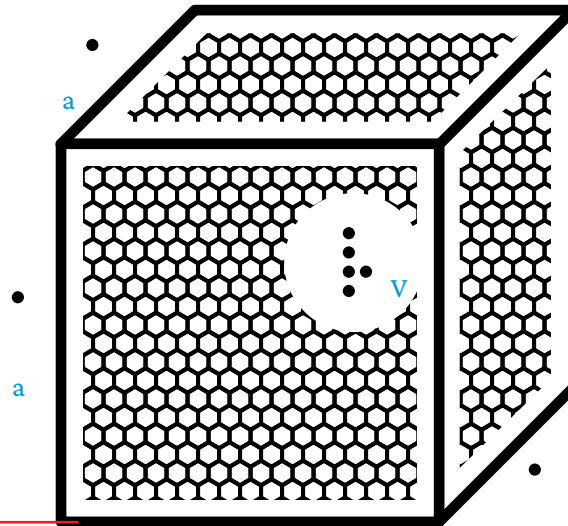

a

a

a

a

Braille text: $V = a * a * a = a^3$

$V = a * a * a = a^3$

Braille text: "Siehe 3D-Modell"

Siehe 3D-Modell

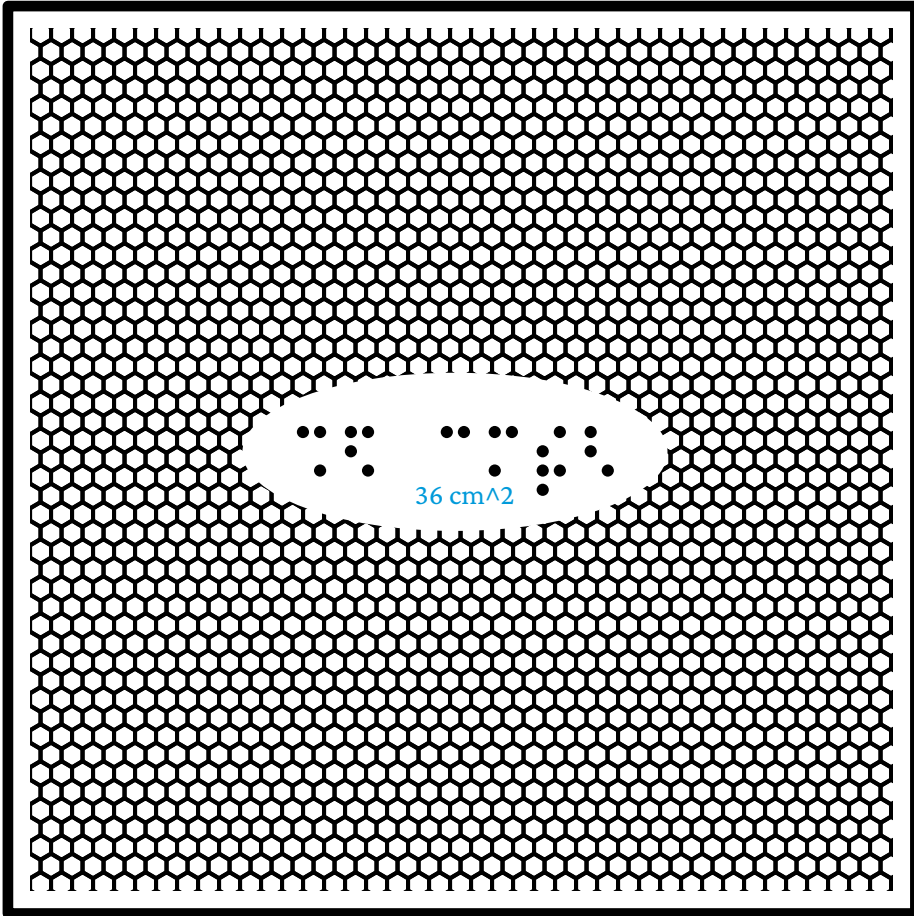
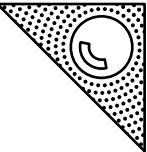

2,25 cm²

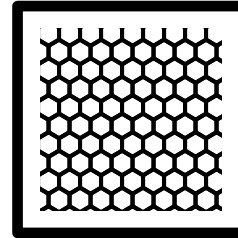

2 cm

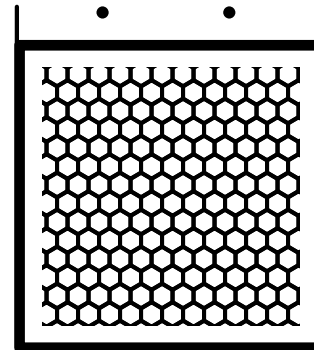

3 cm

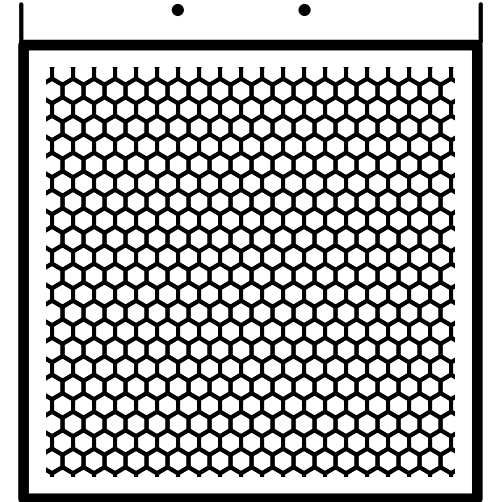

1,44 cm²

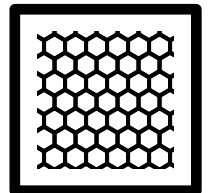

1 cm²

1 cm²

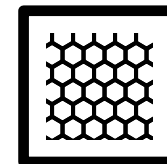

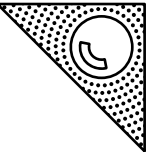

Braille: $y=4$

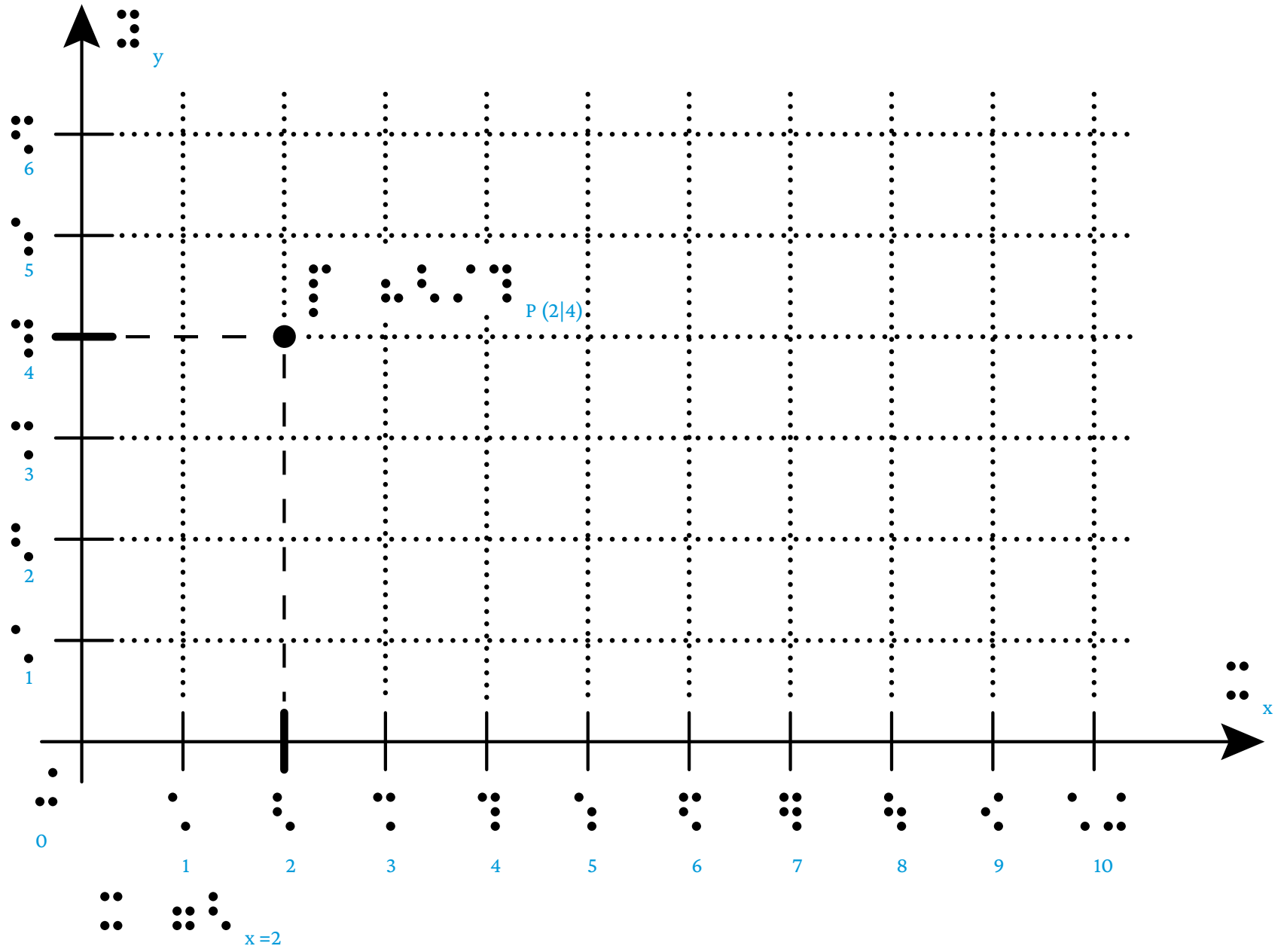

Braille: $x=2$

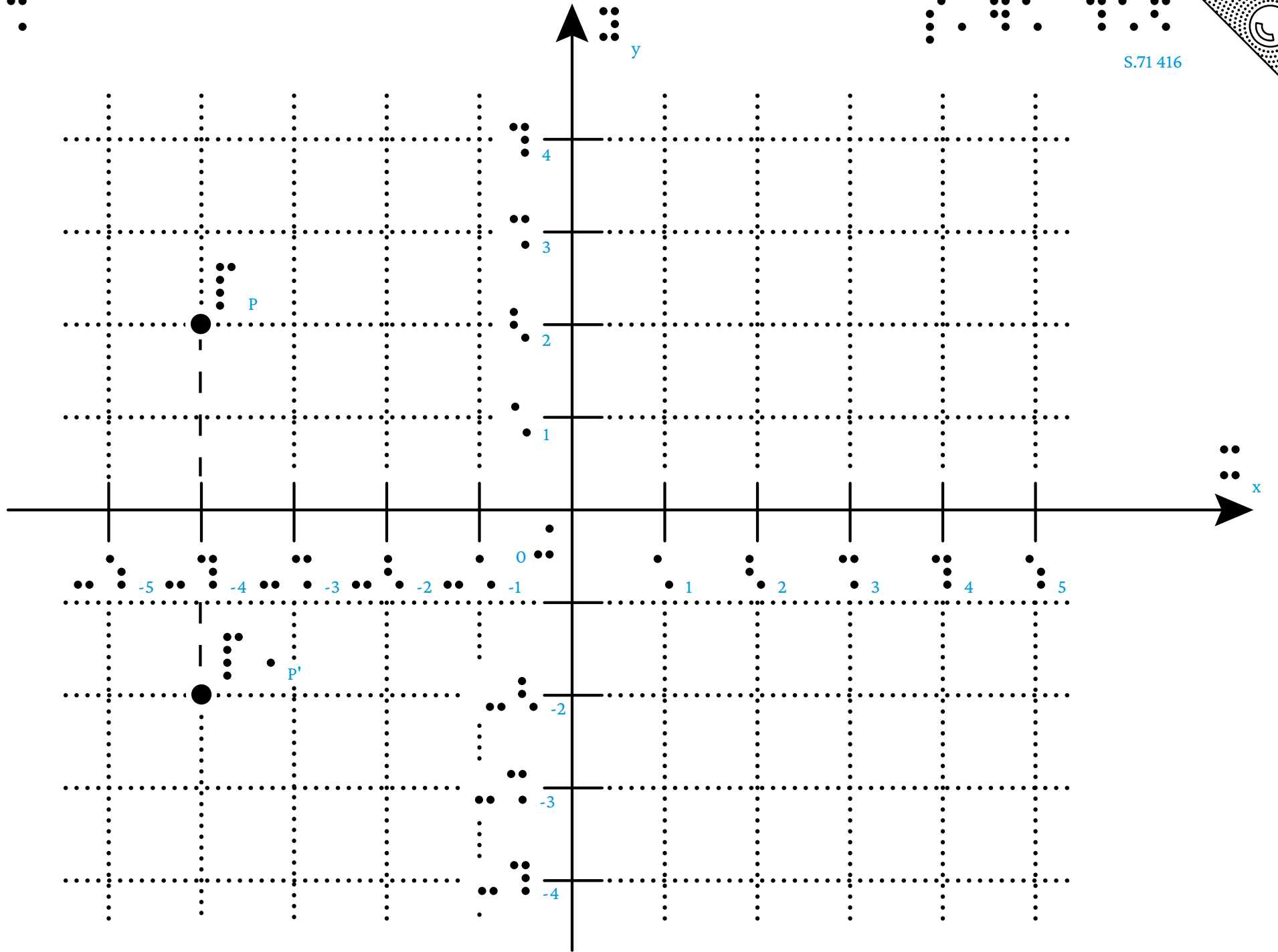
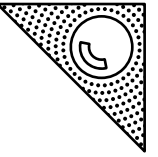

MVÜA3

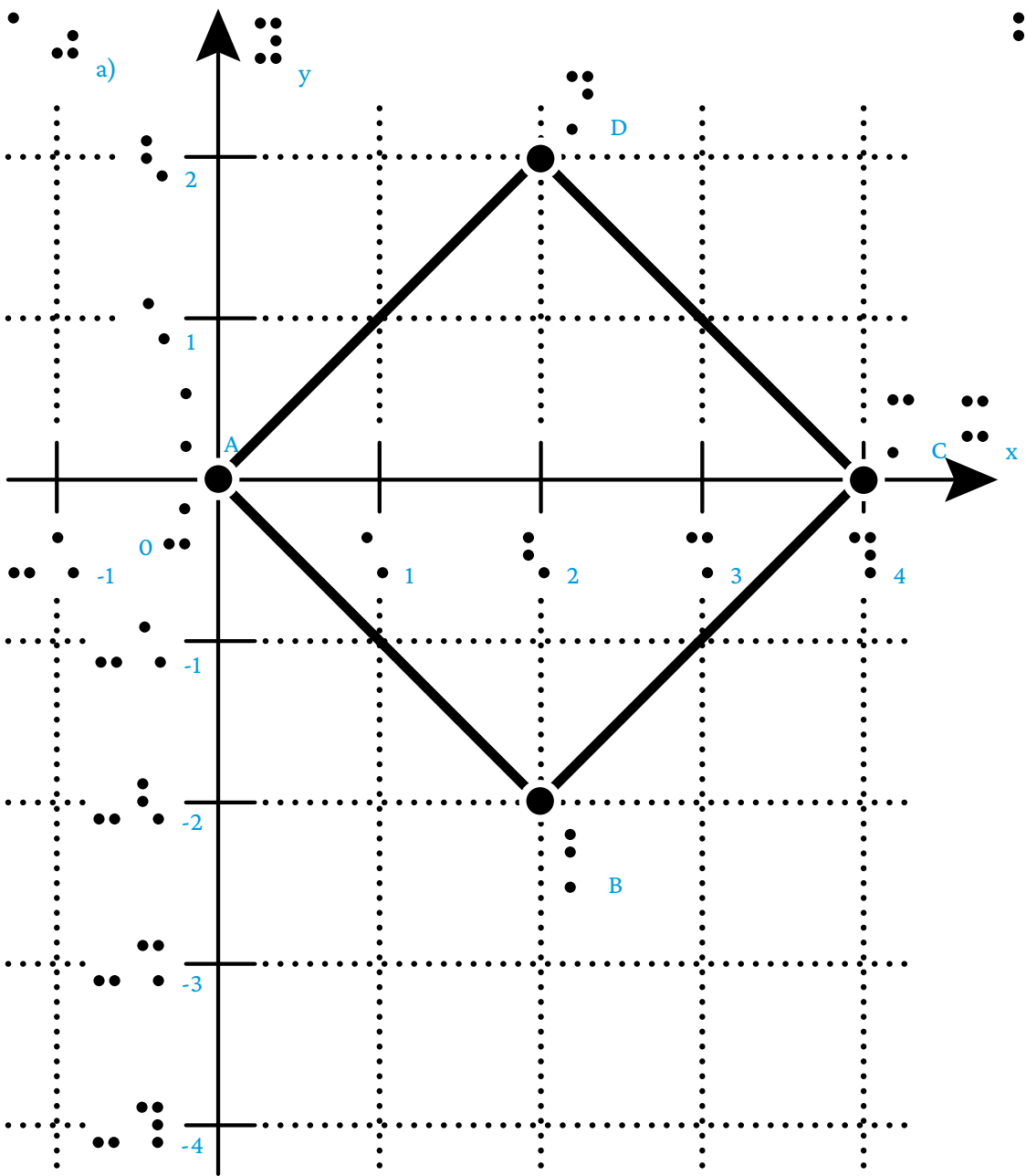

S.74 436 a), b)

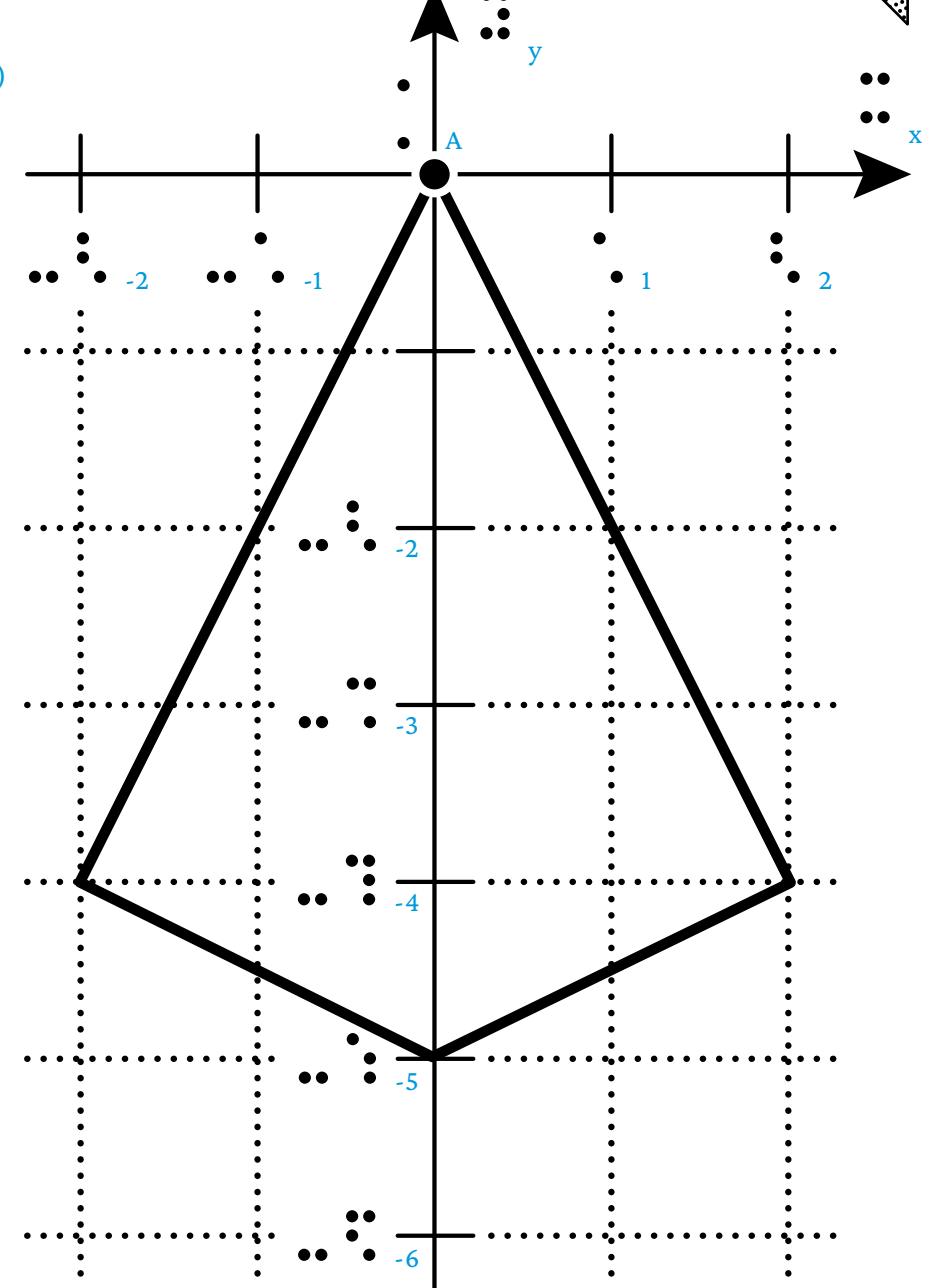

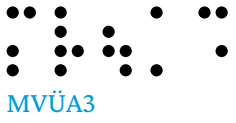

MVÜA3



c)

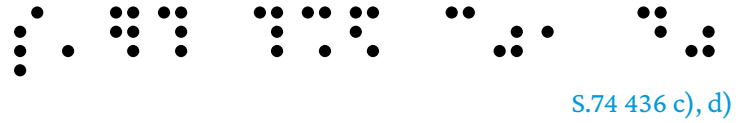
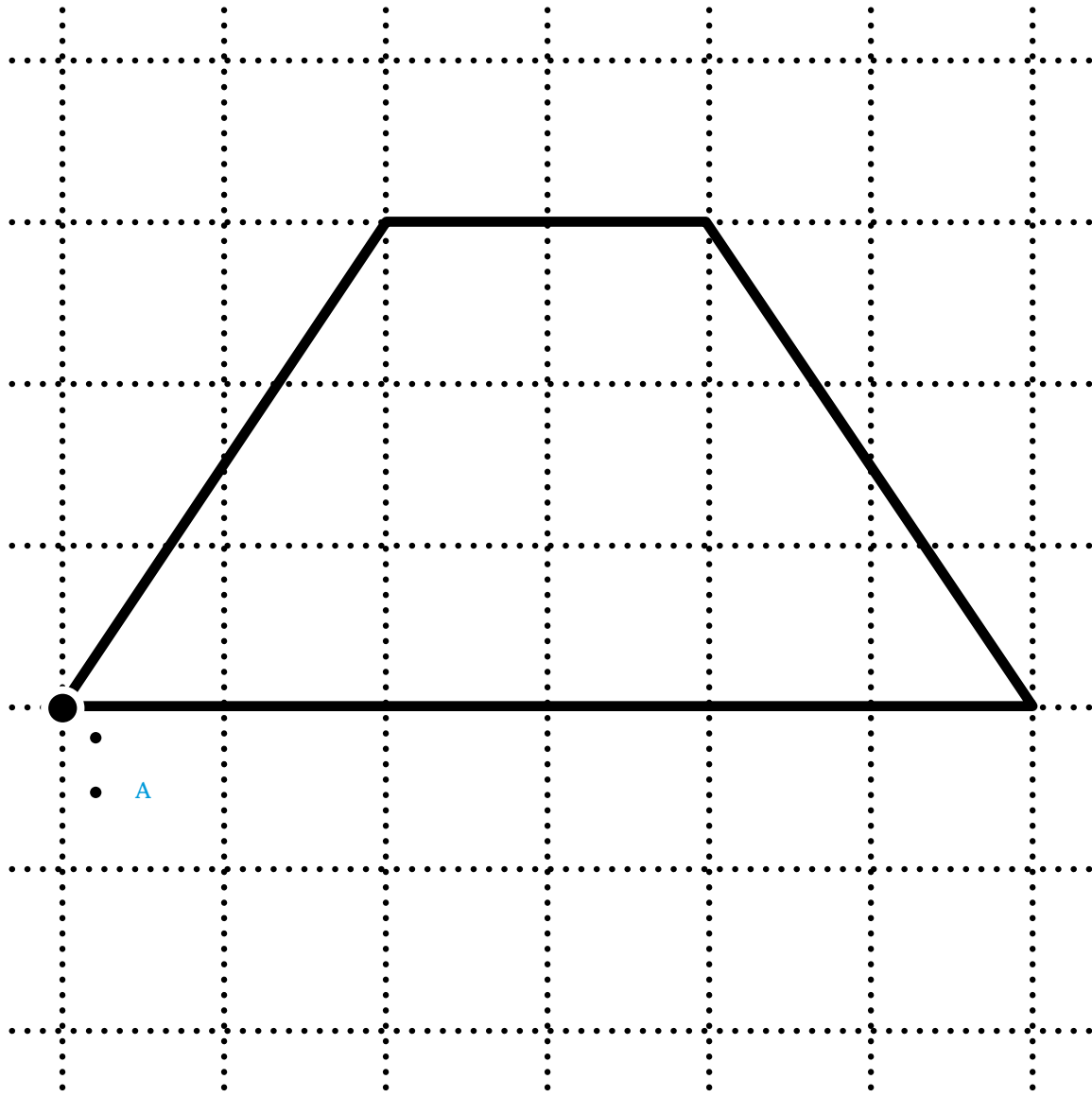

S.74 436 c), d)

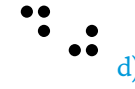

d)

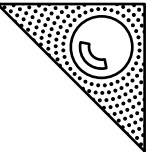
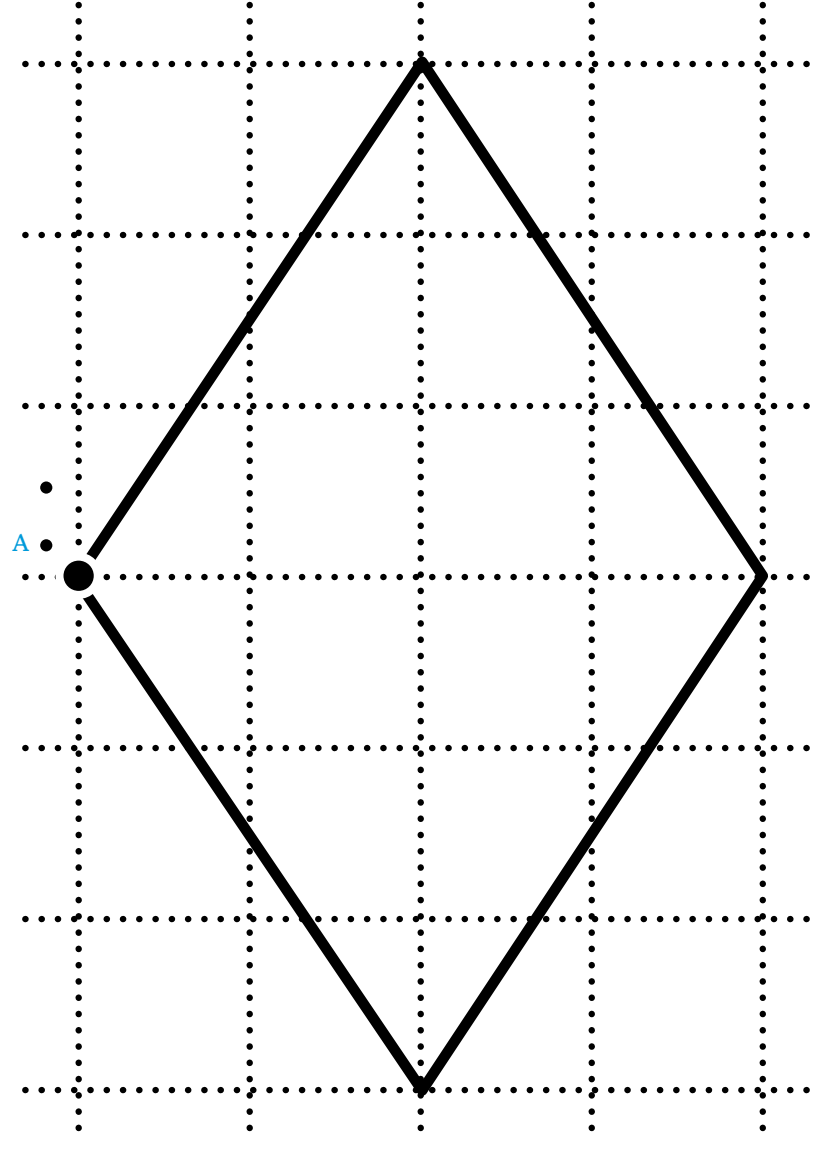

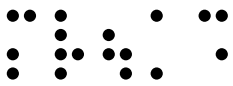

MVÜA3

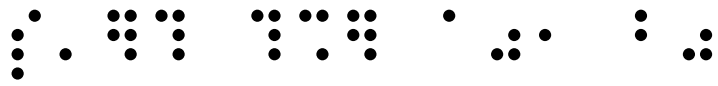

S.74 437 a), b)

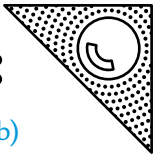

a)

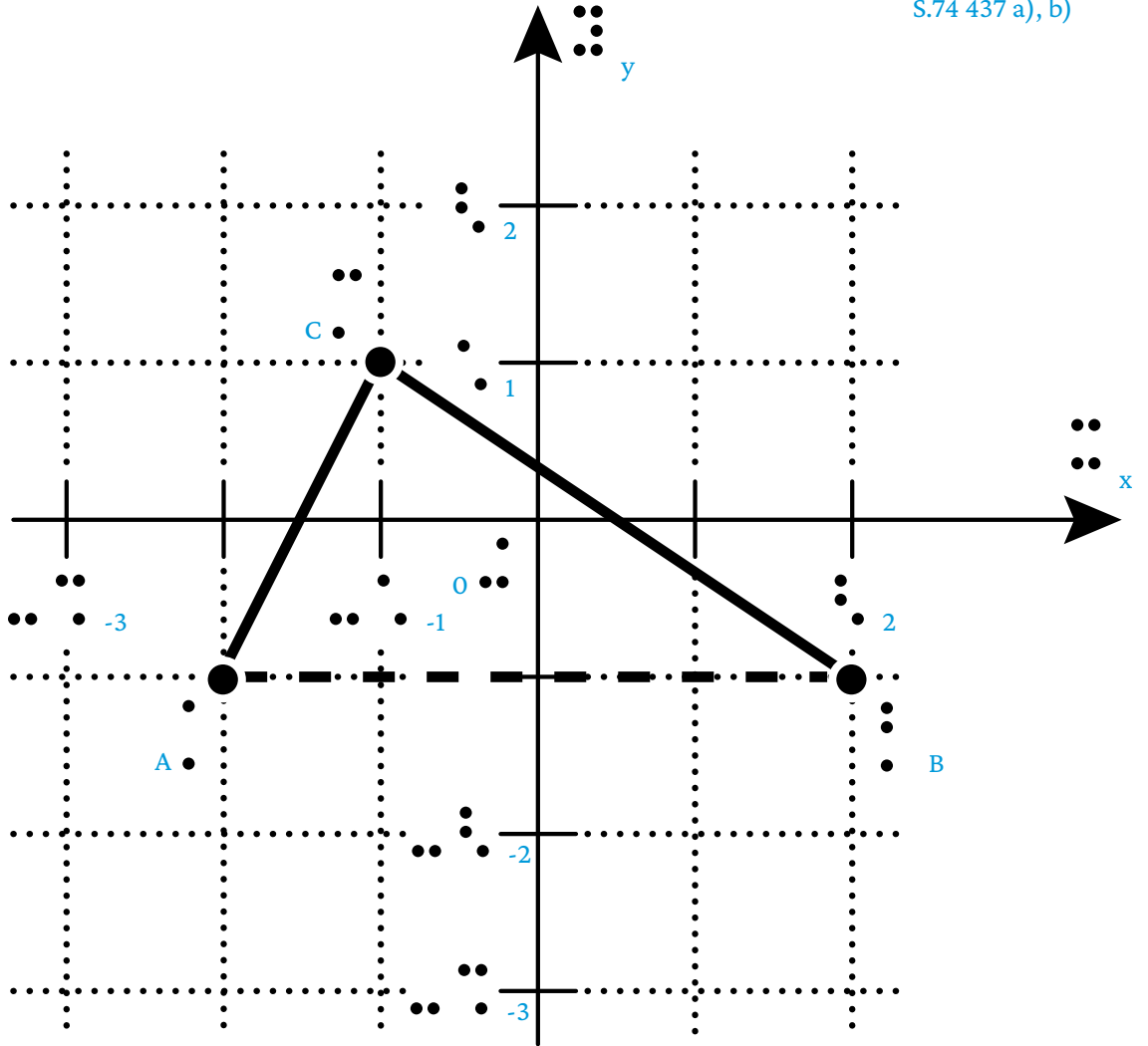

b)

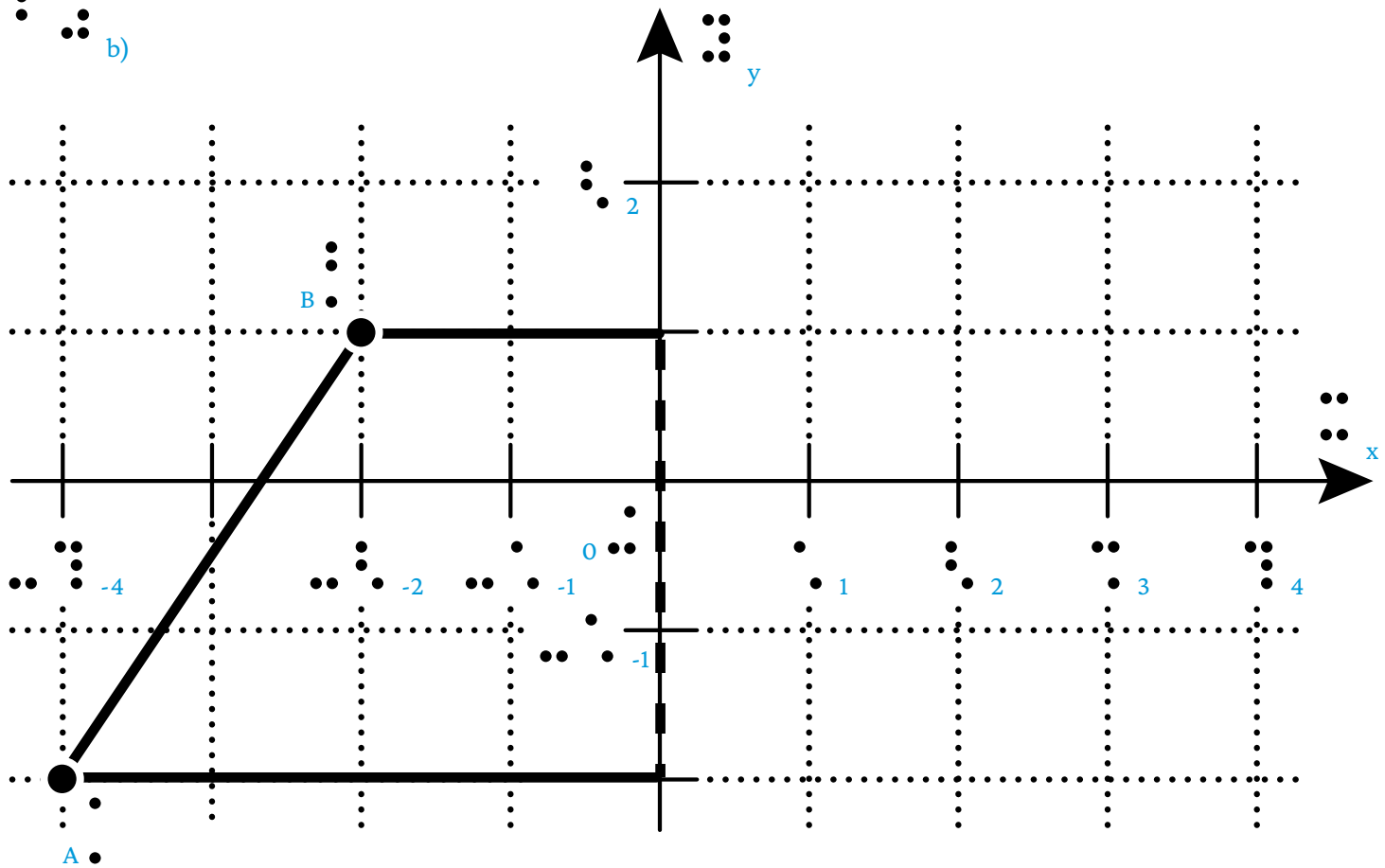

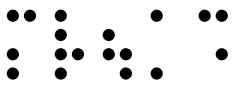

MVÜA3

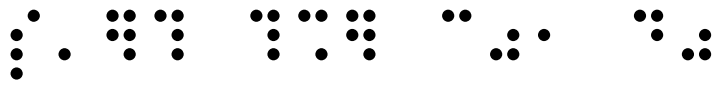

S.74 437 c), d)

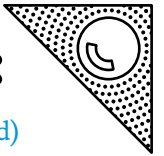

c)

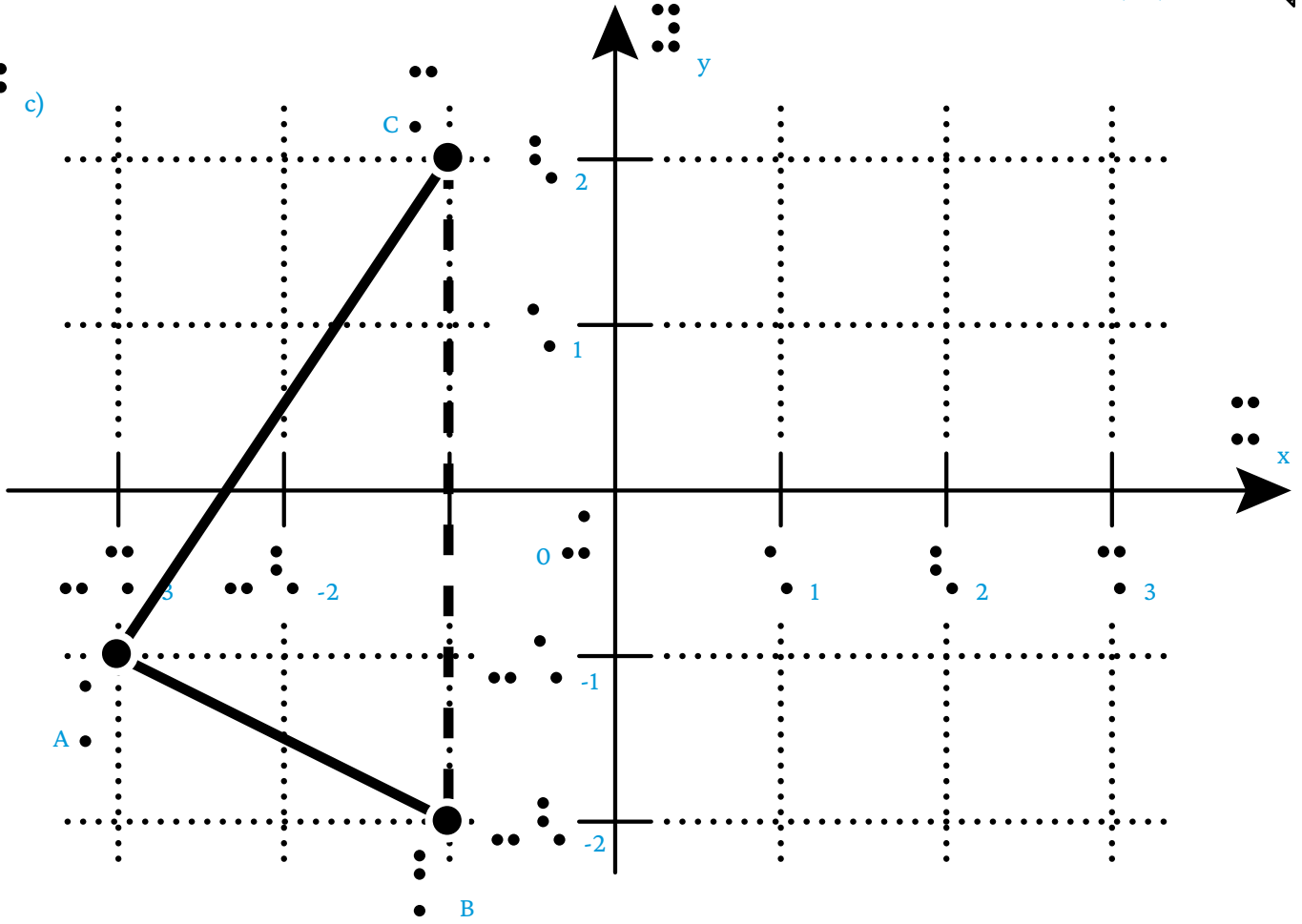

d)

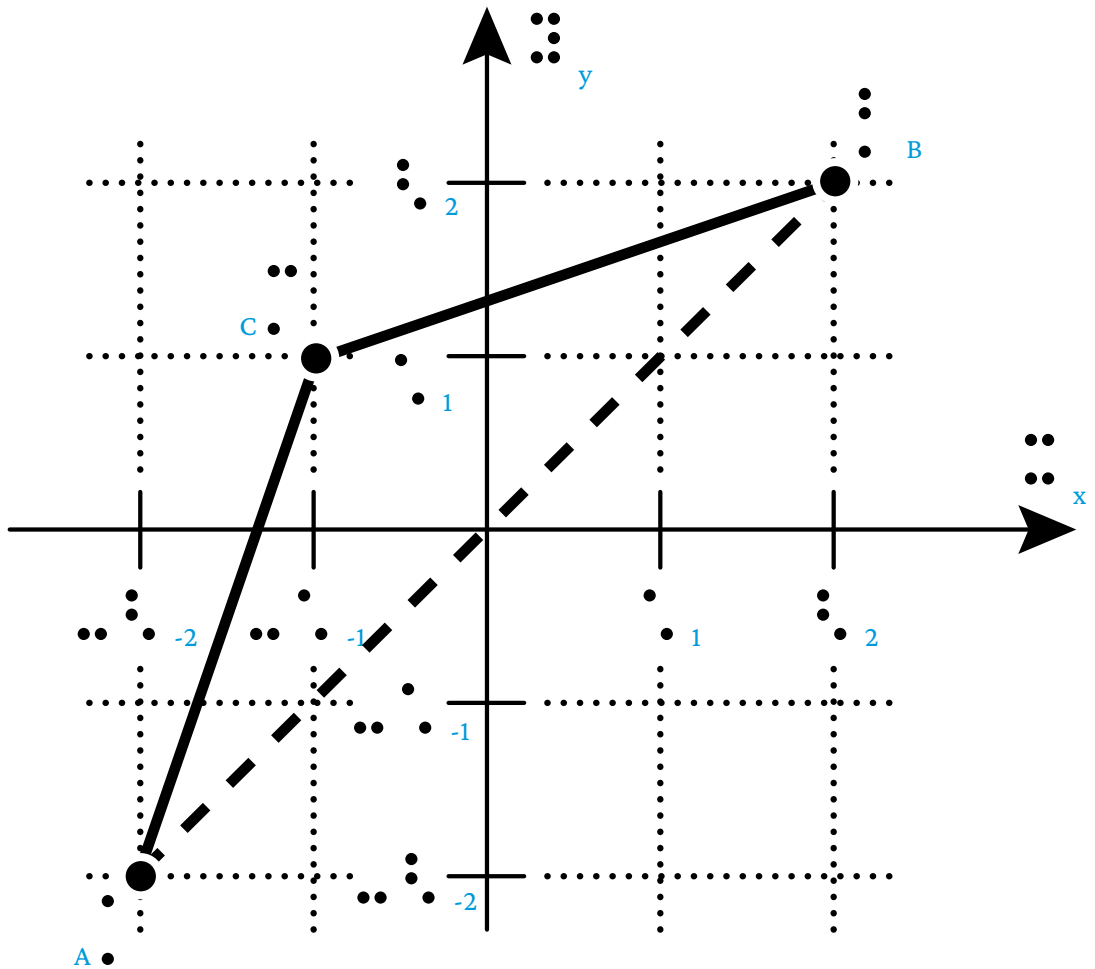

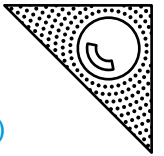

MVÜA3

S.74 440 a), b)

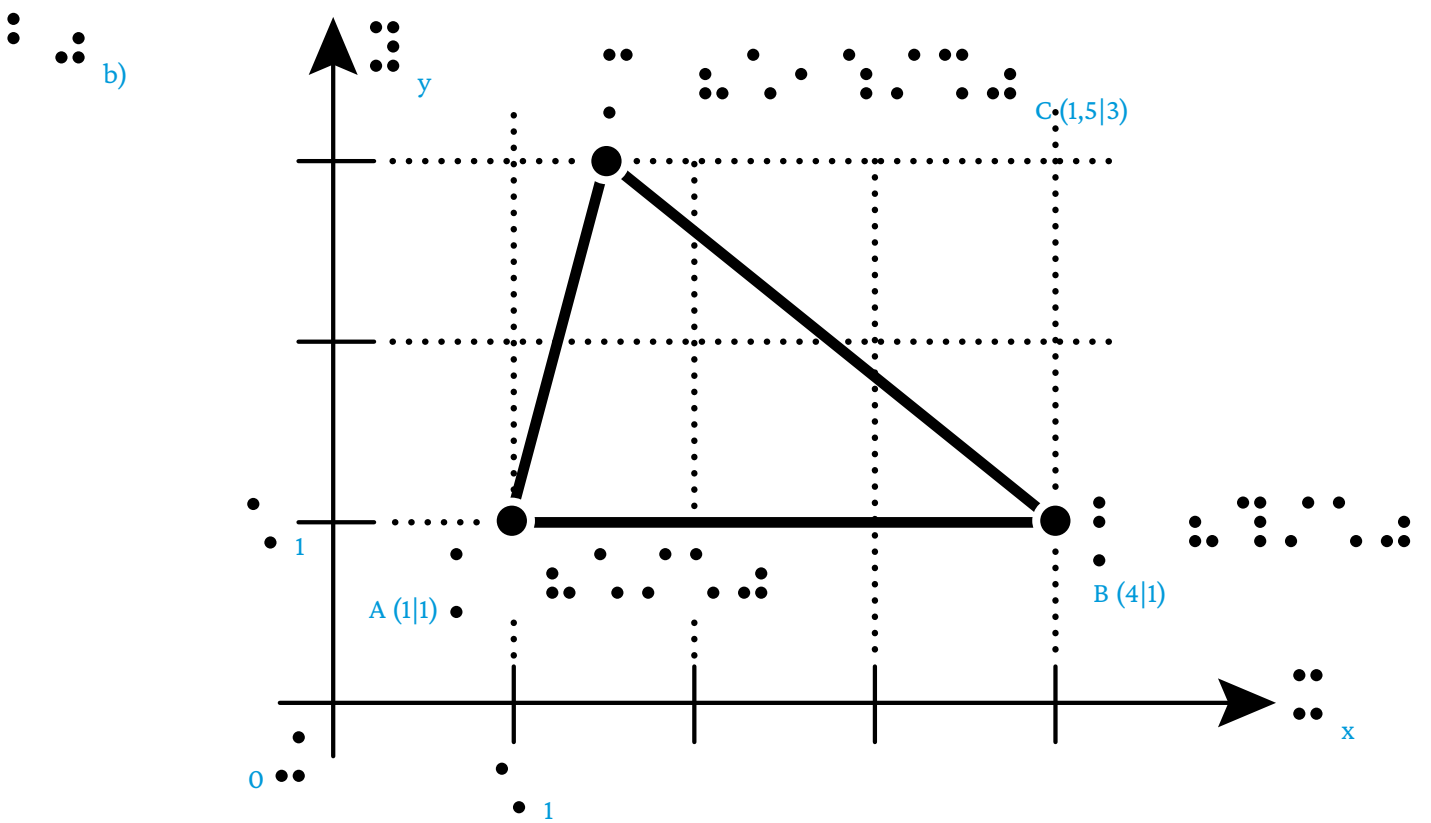
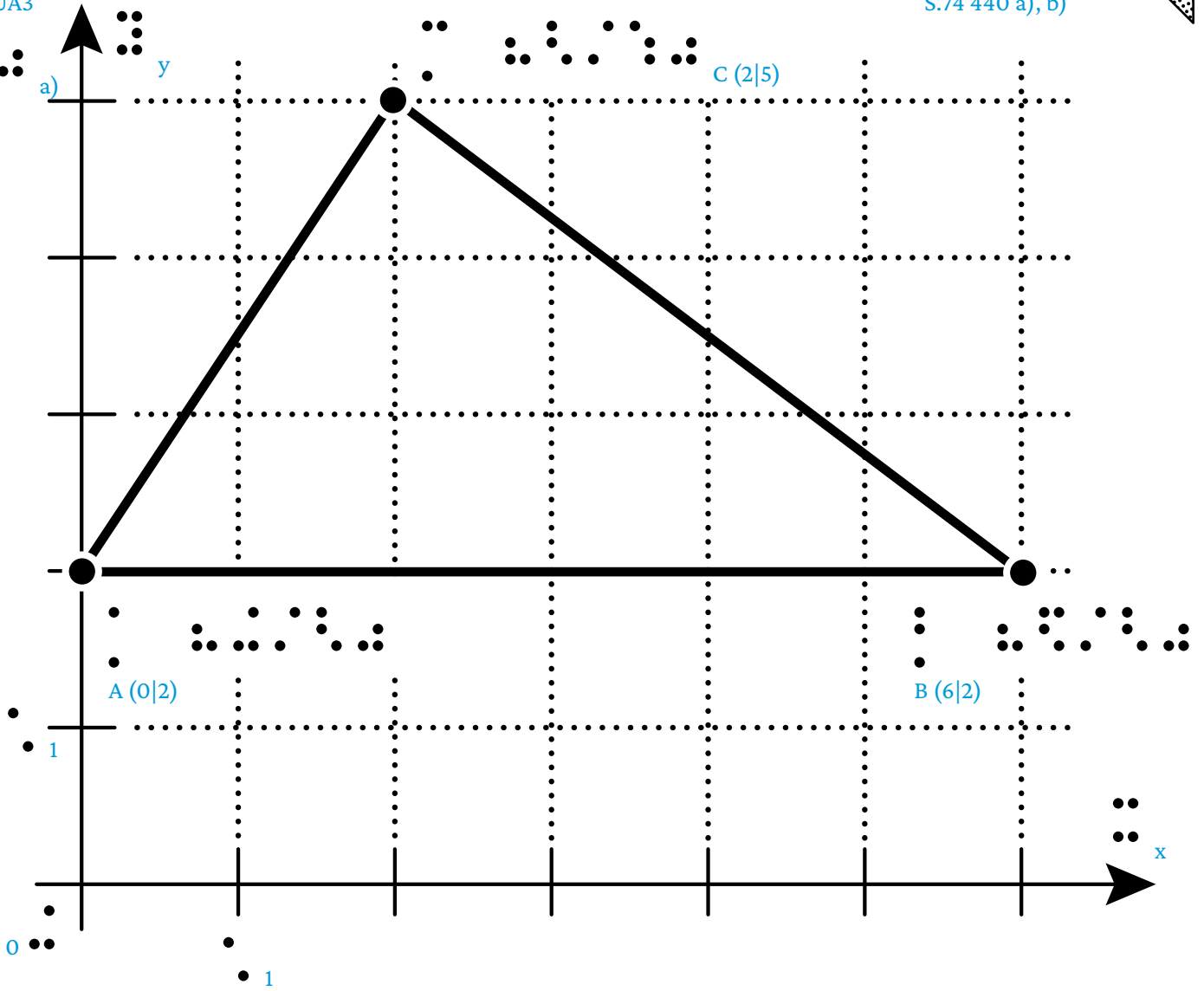

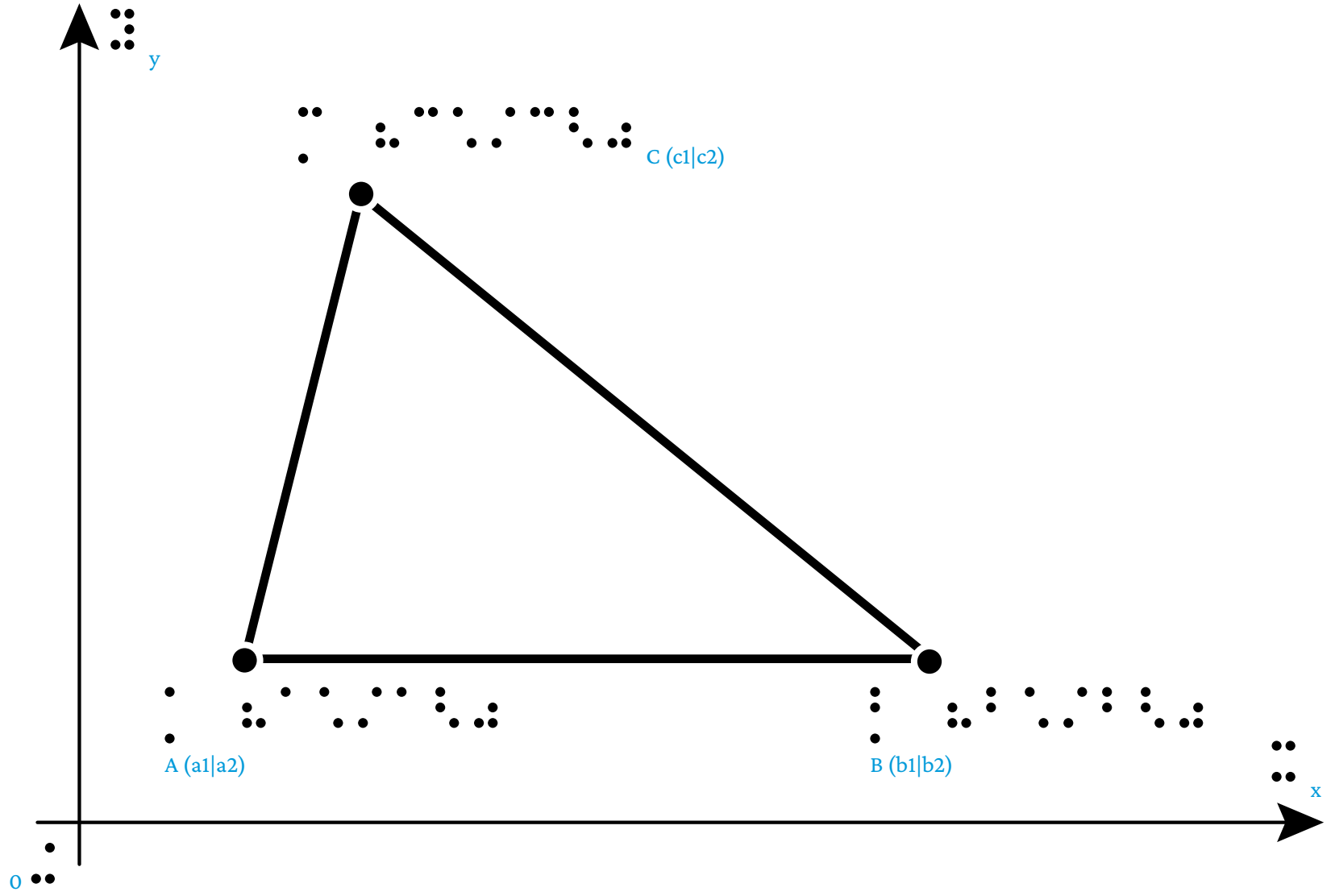
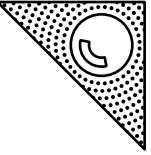

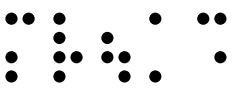

MVÜA3

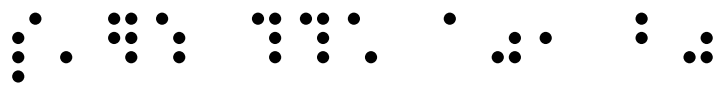

S.75 441 a), b)

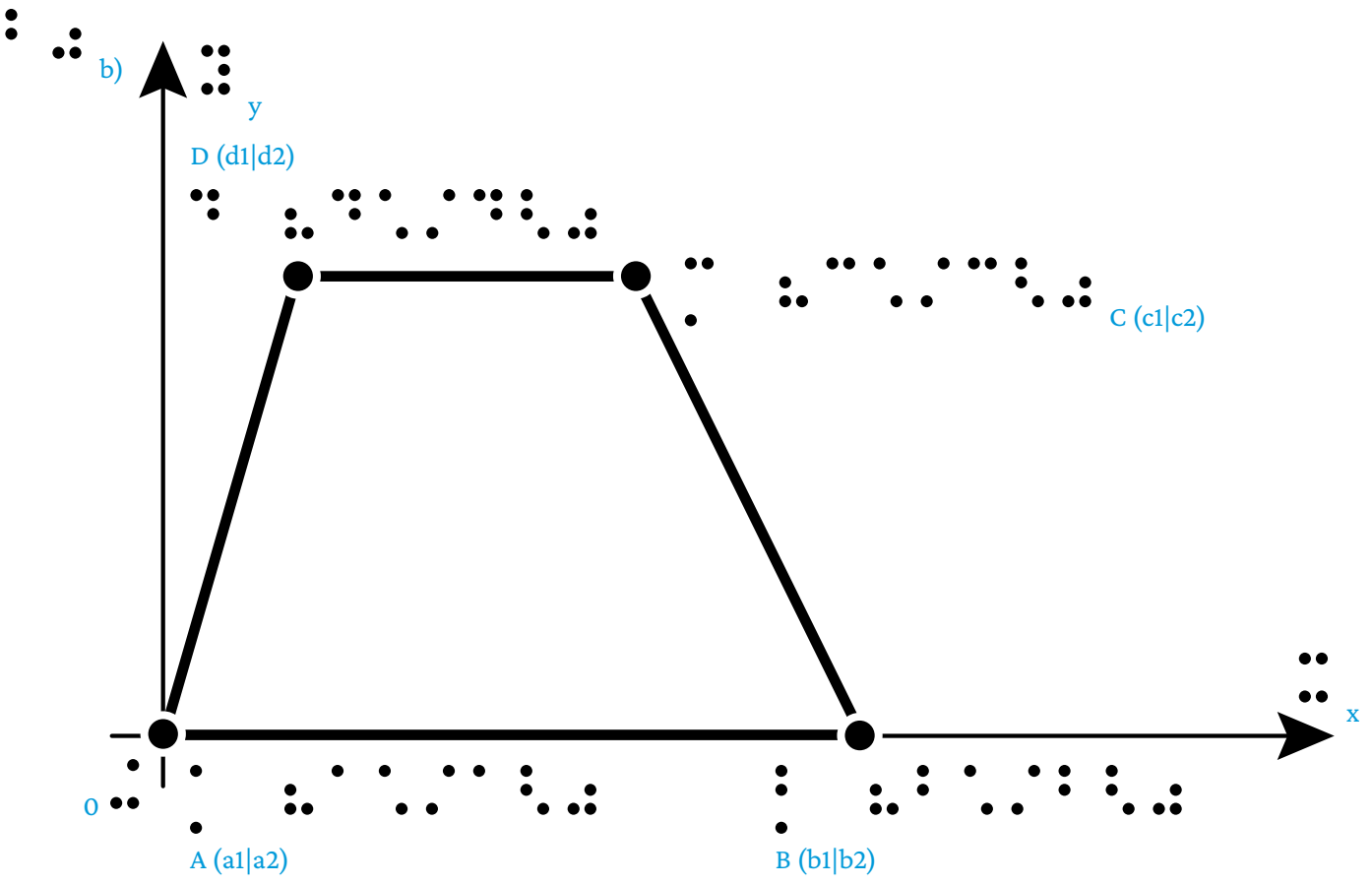
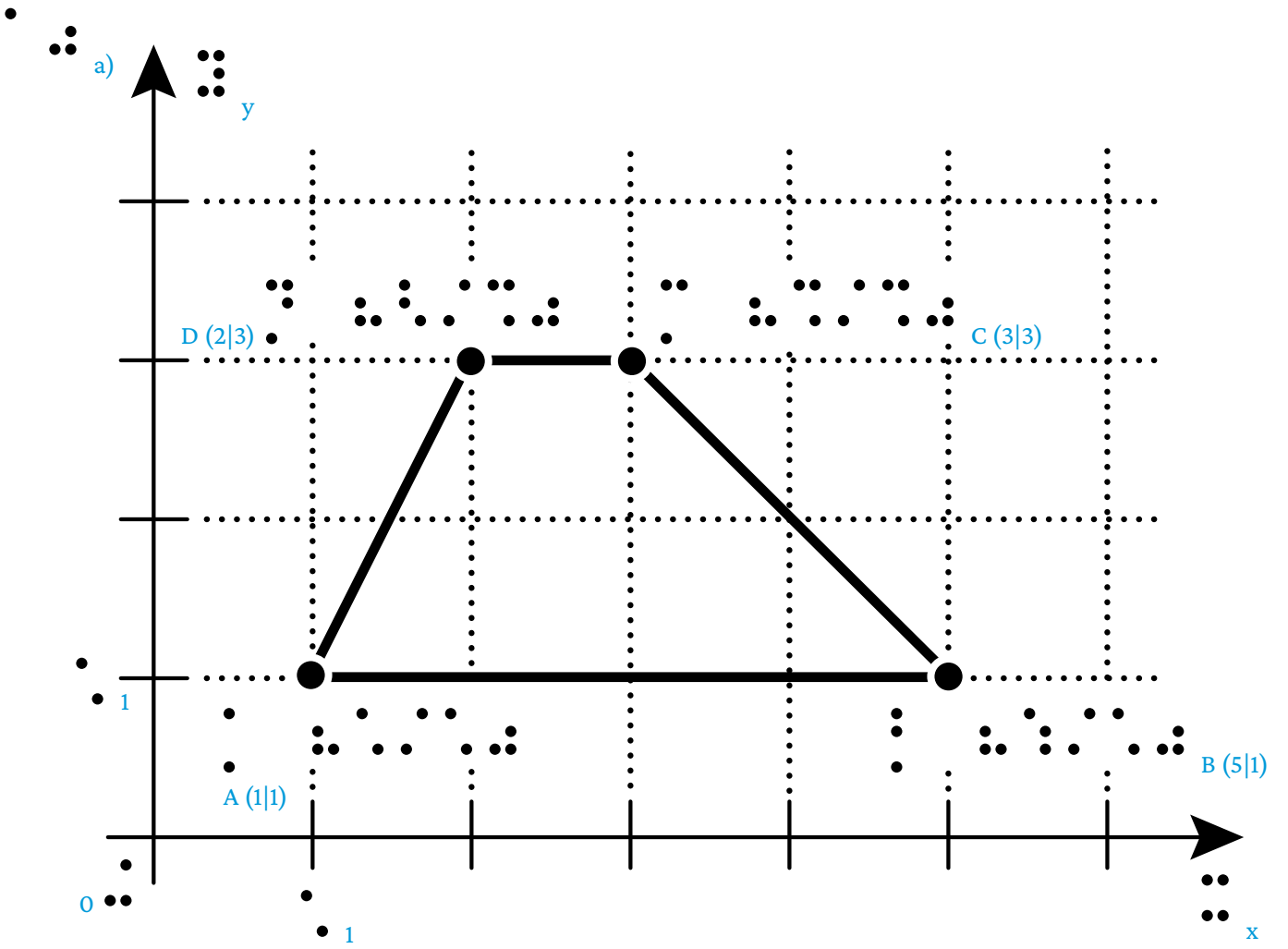
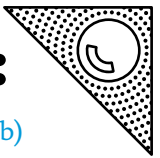

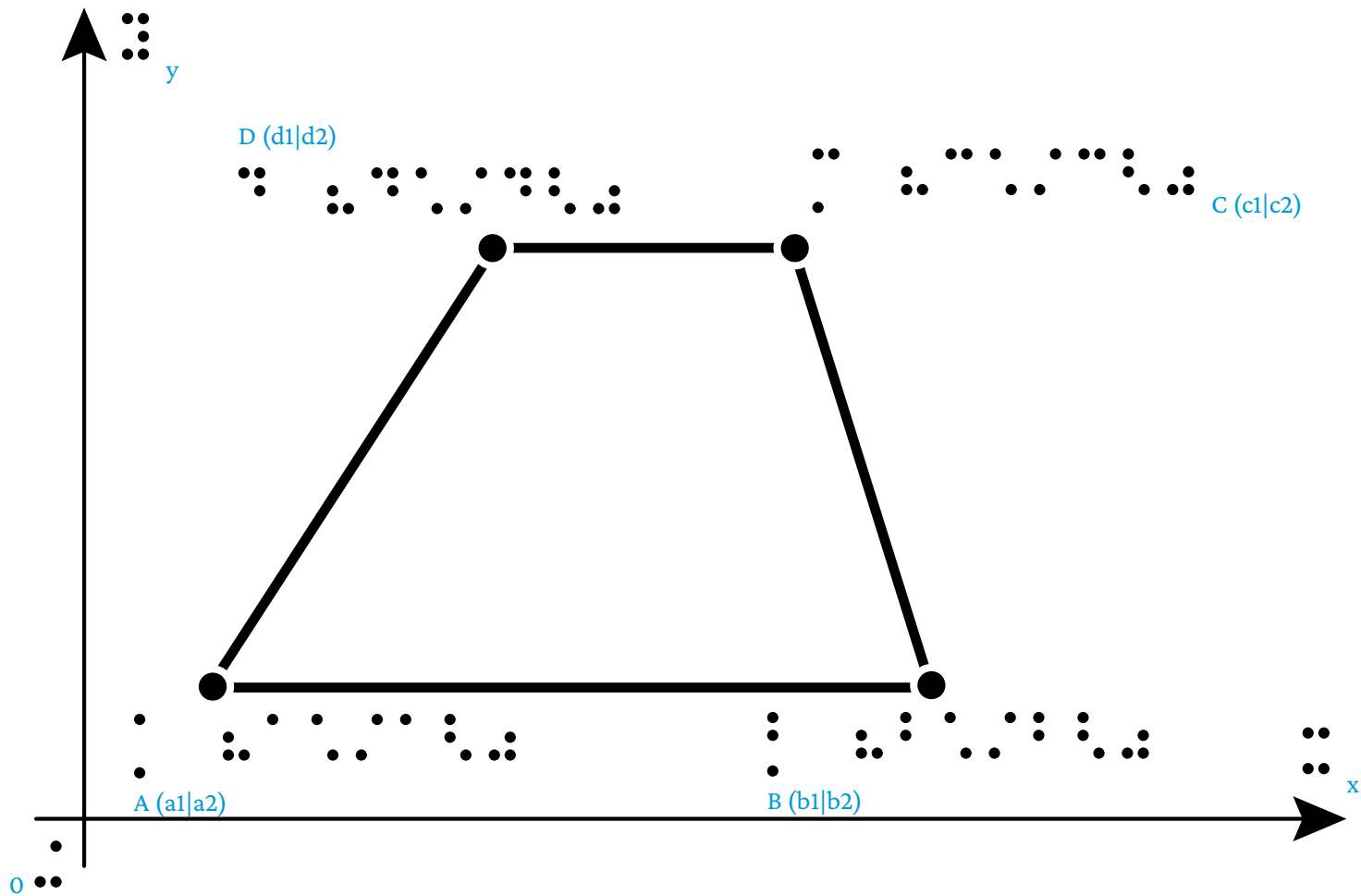
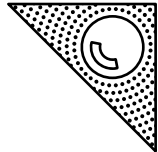

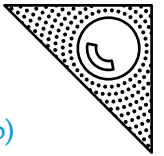

MVÜA3

S.75 442 a), b)

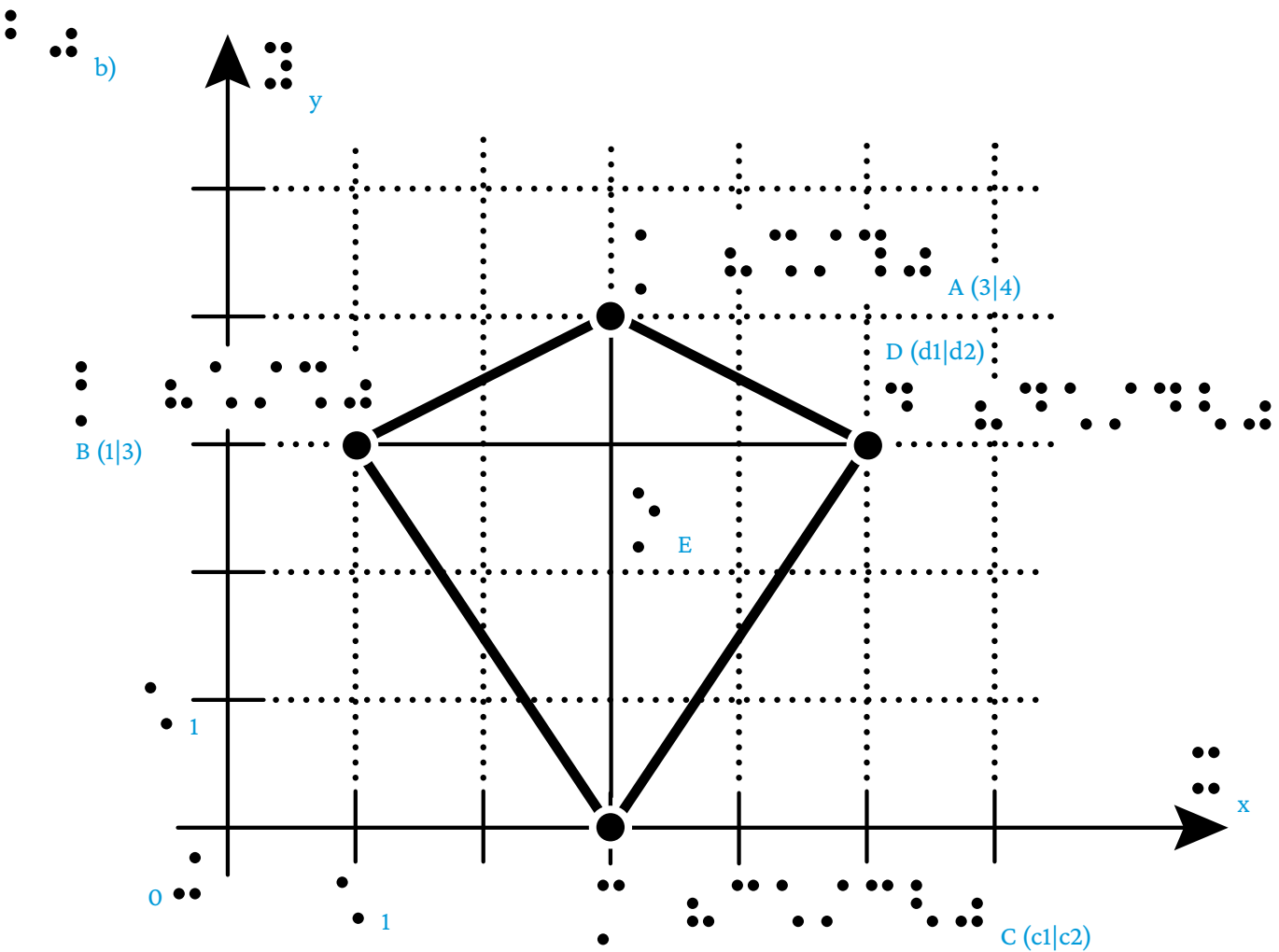
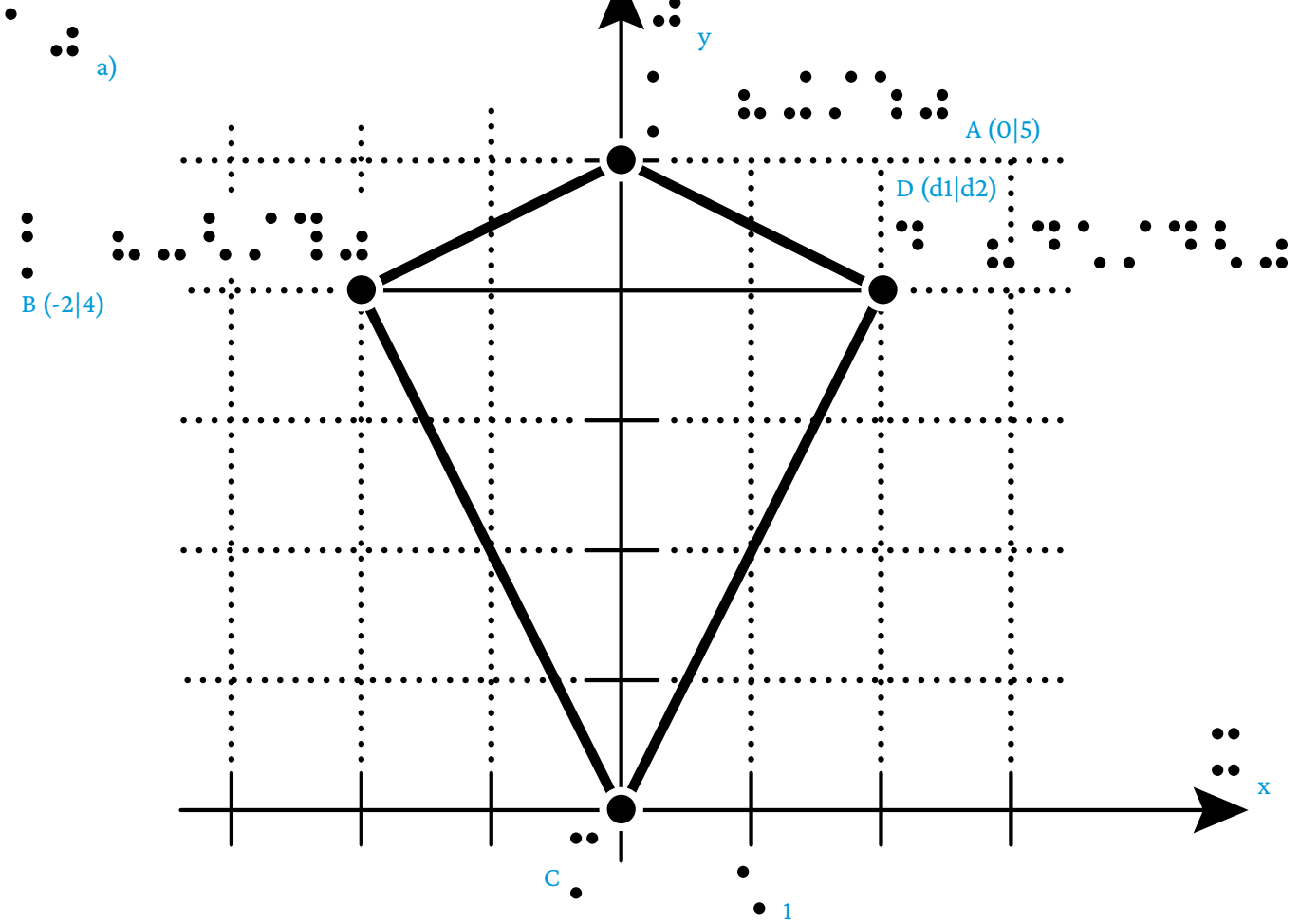

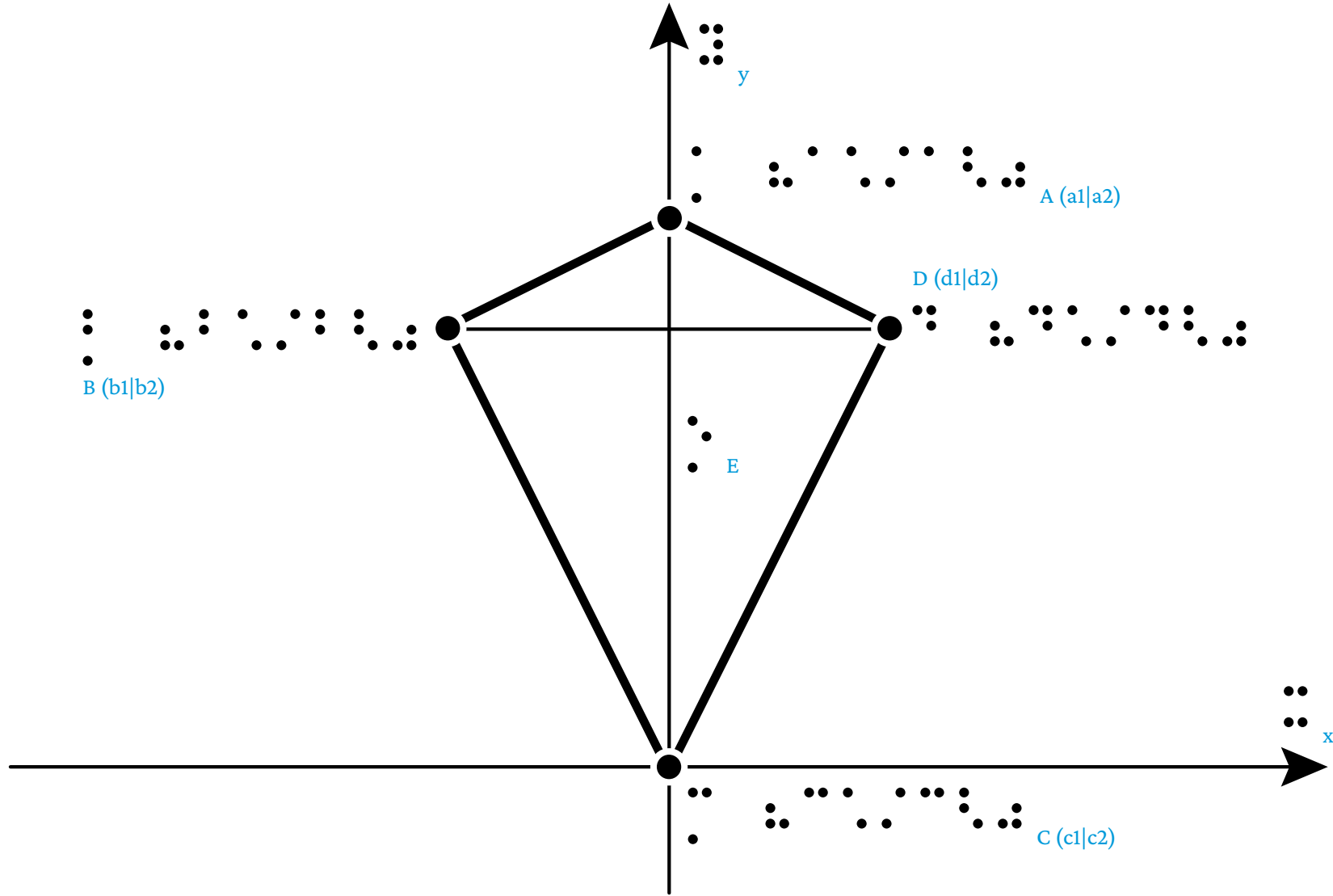
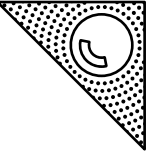

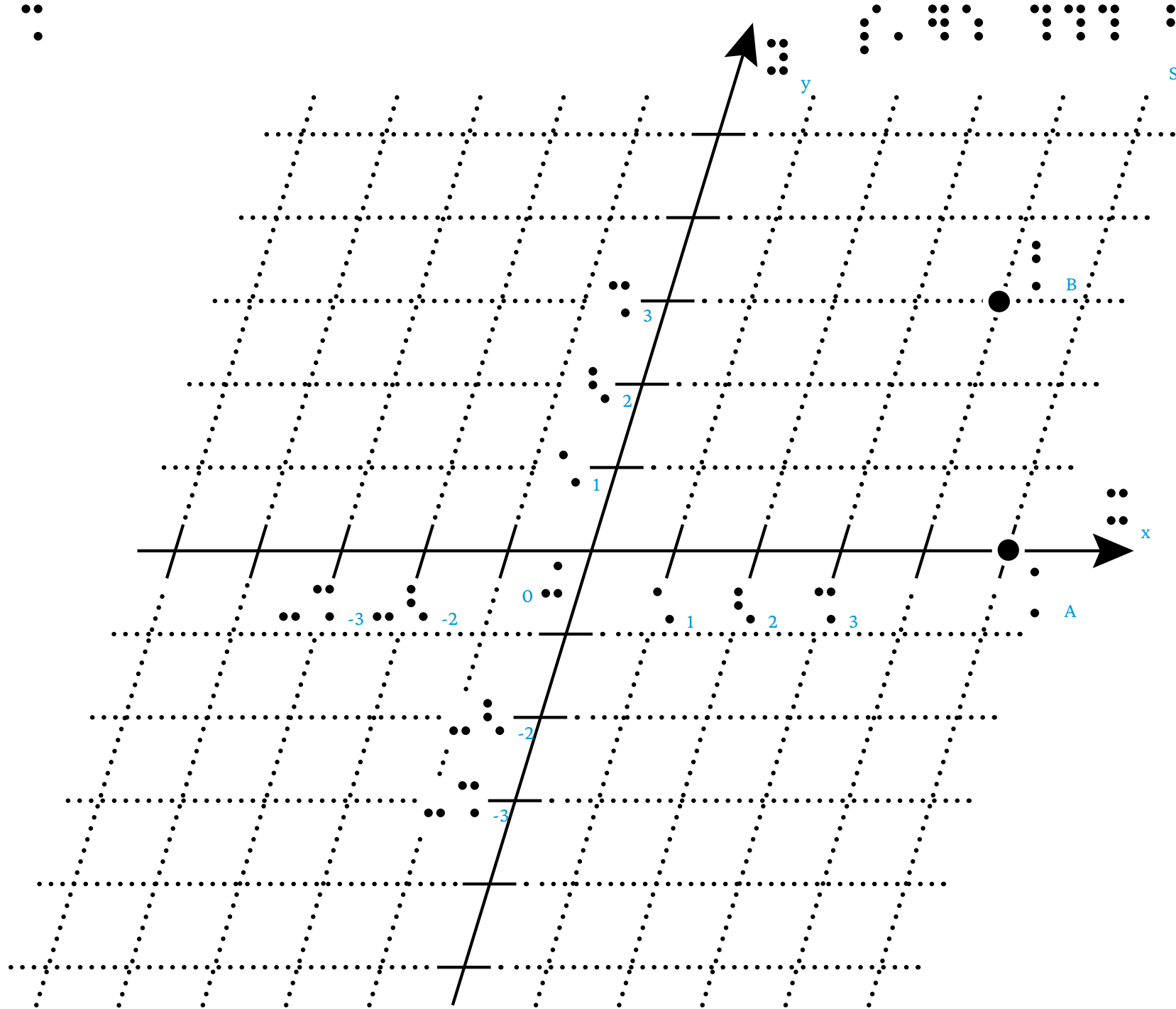
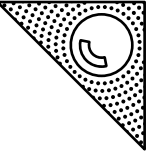

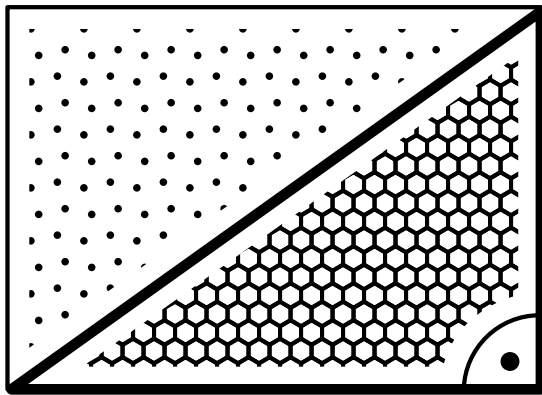
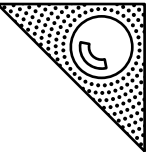

a

b

a)

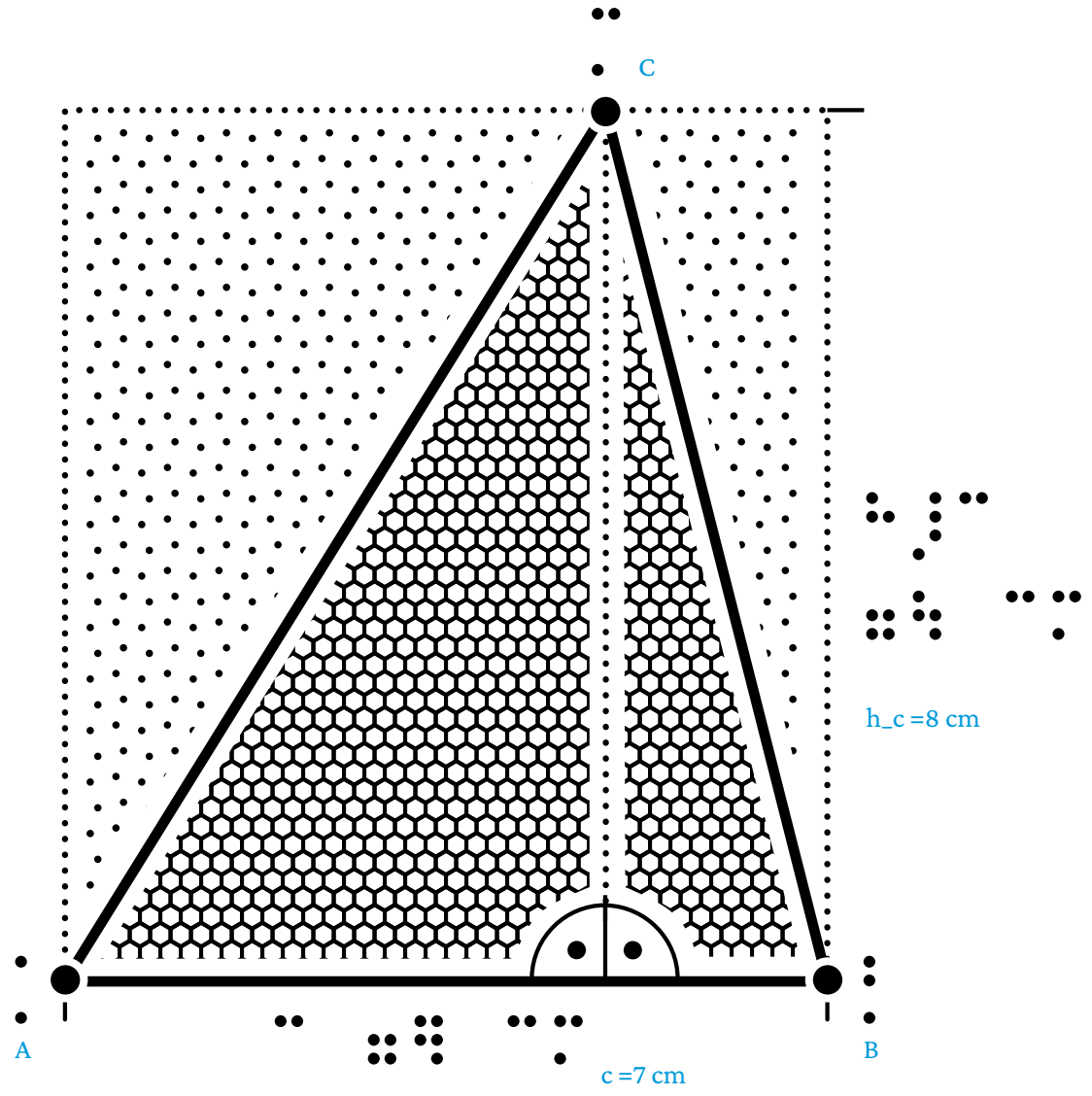

A

B

$c = 7 \text{ cm}$

$h_c = 8 \text{ cm}$

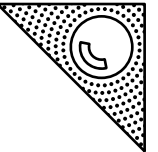

b)

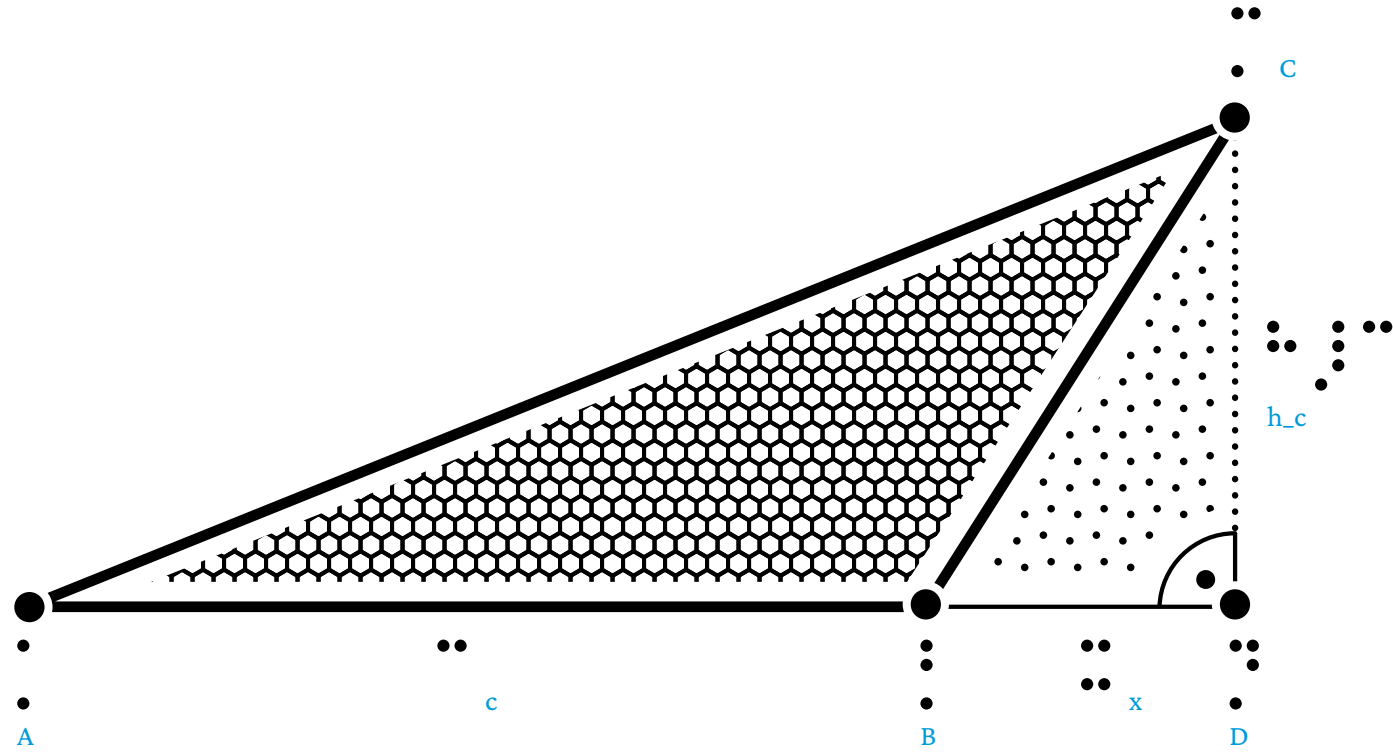

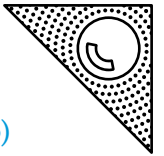

a)

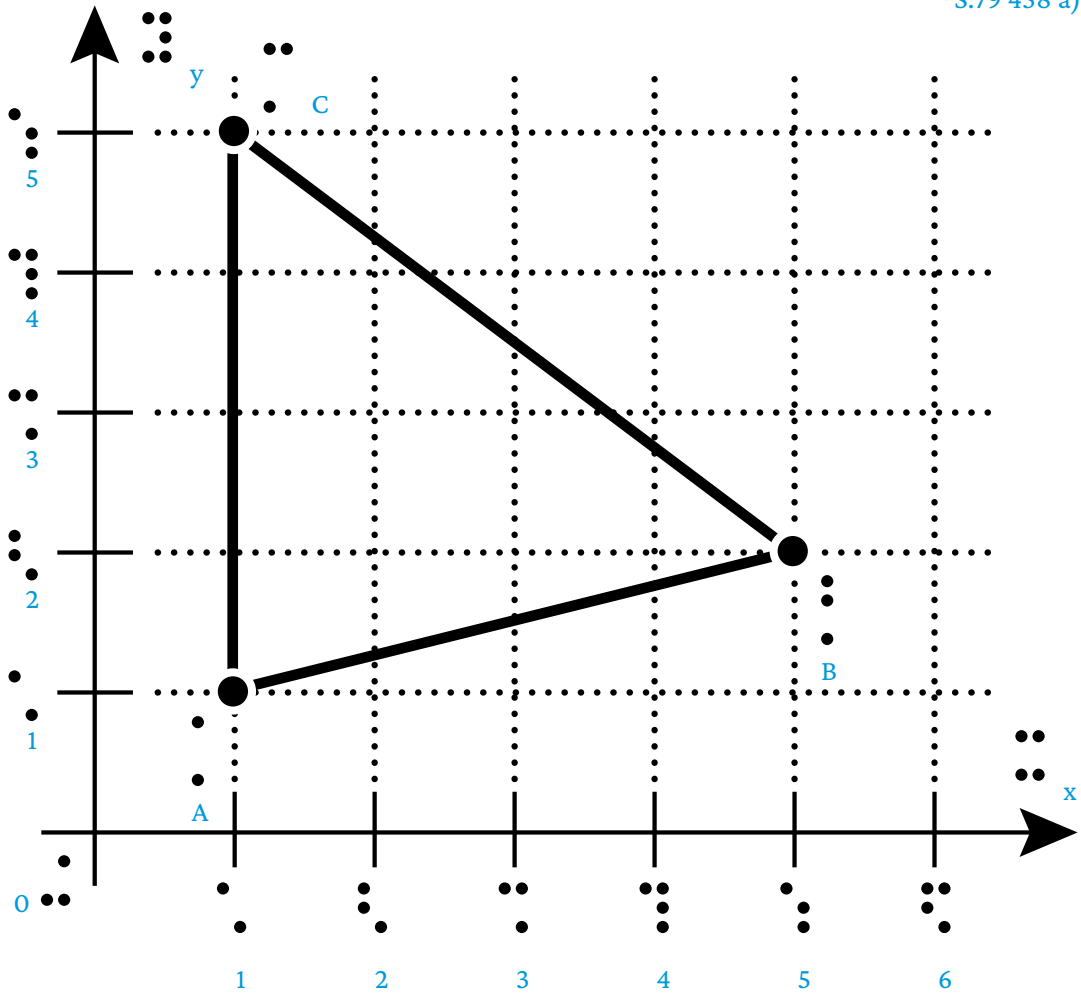

b)

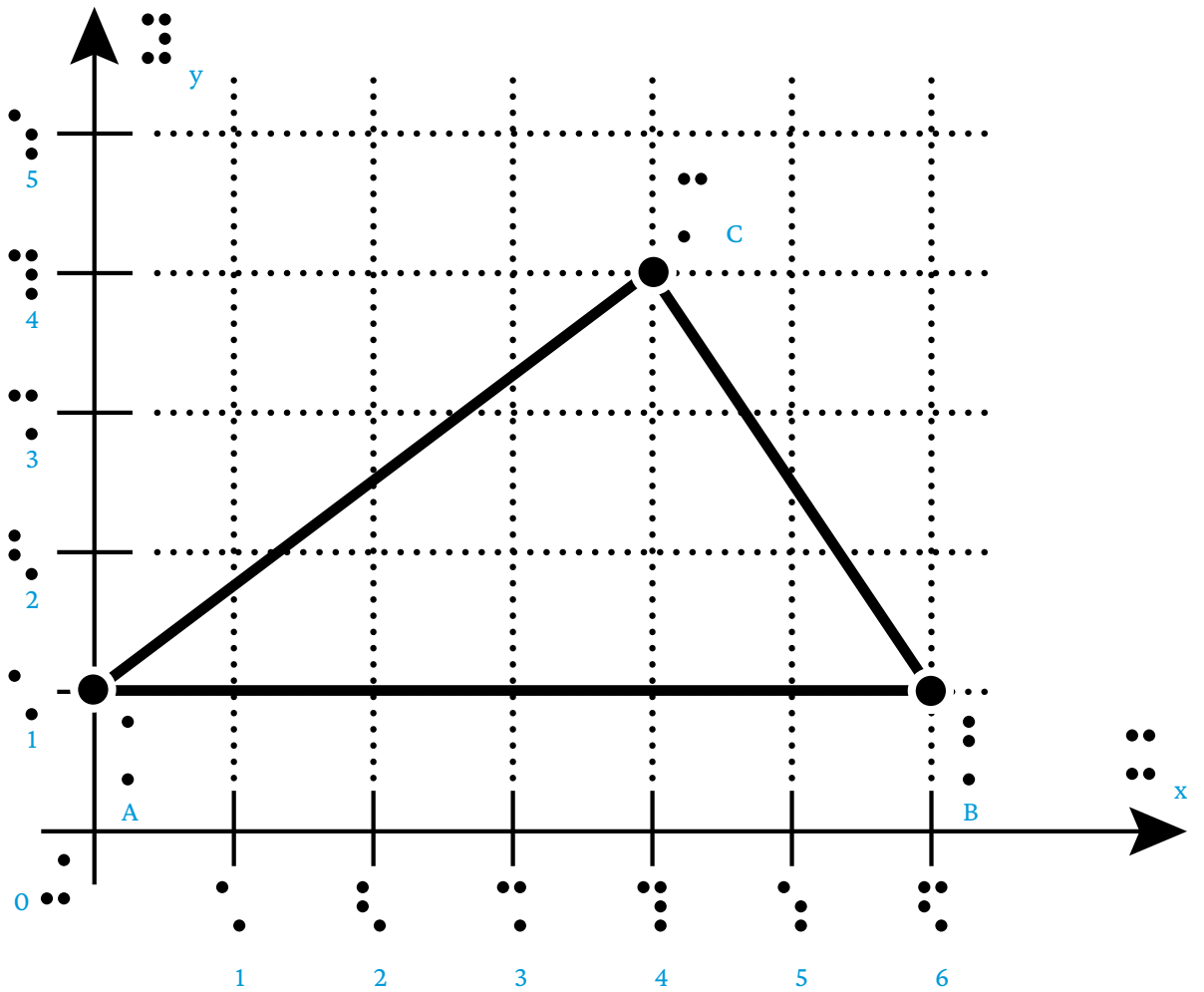

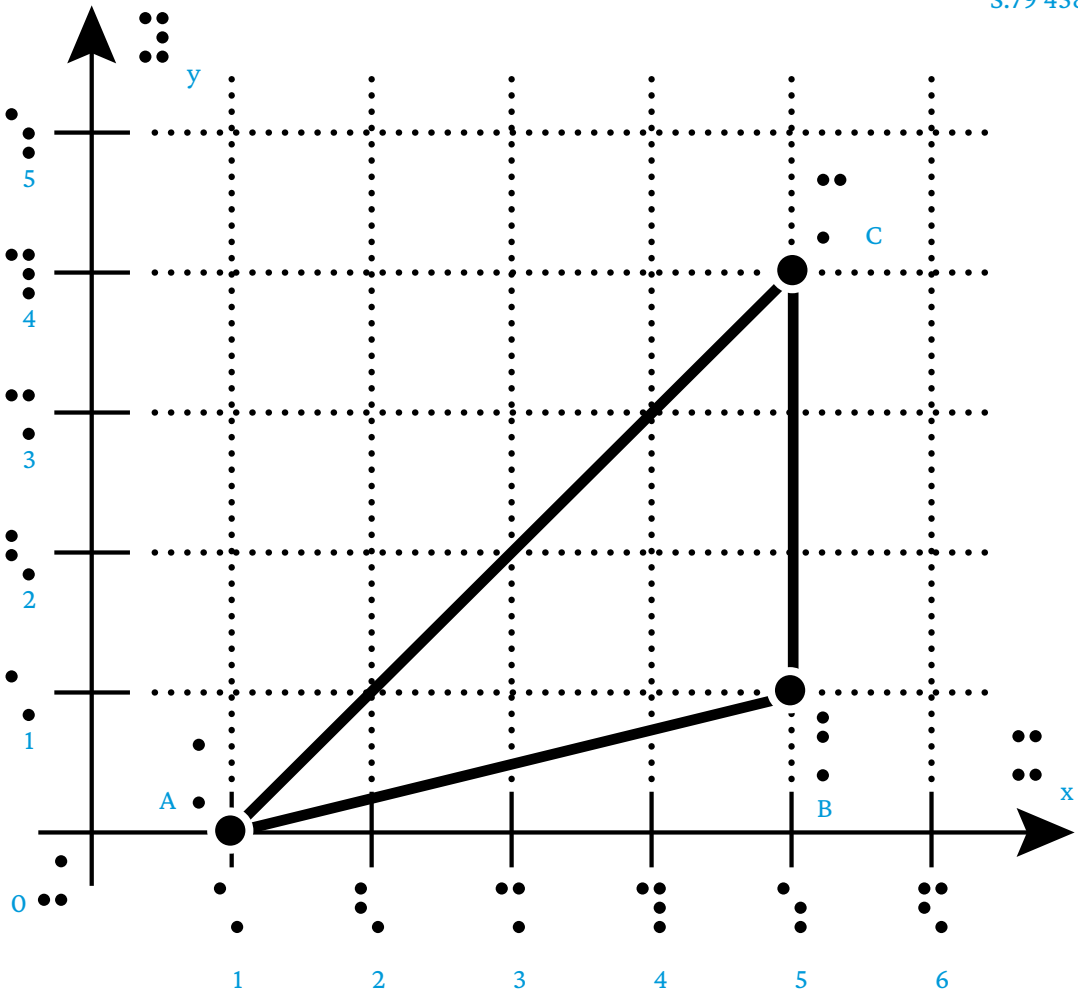
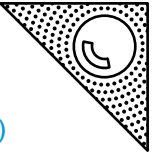
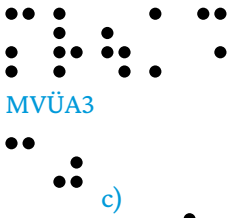

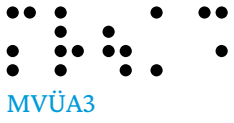

MVÜA3



a)



S.79 459 a)

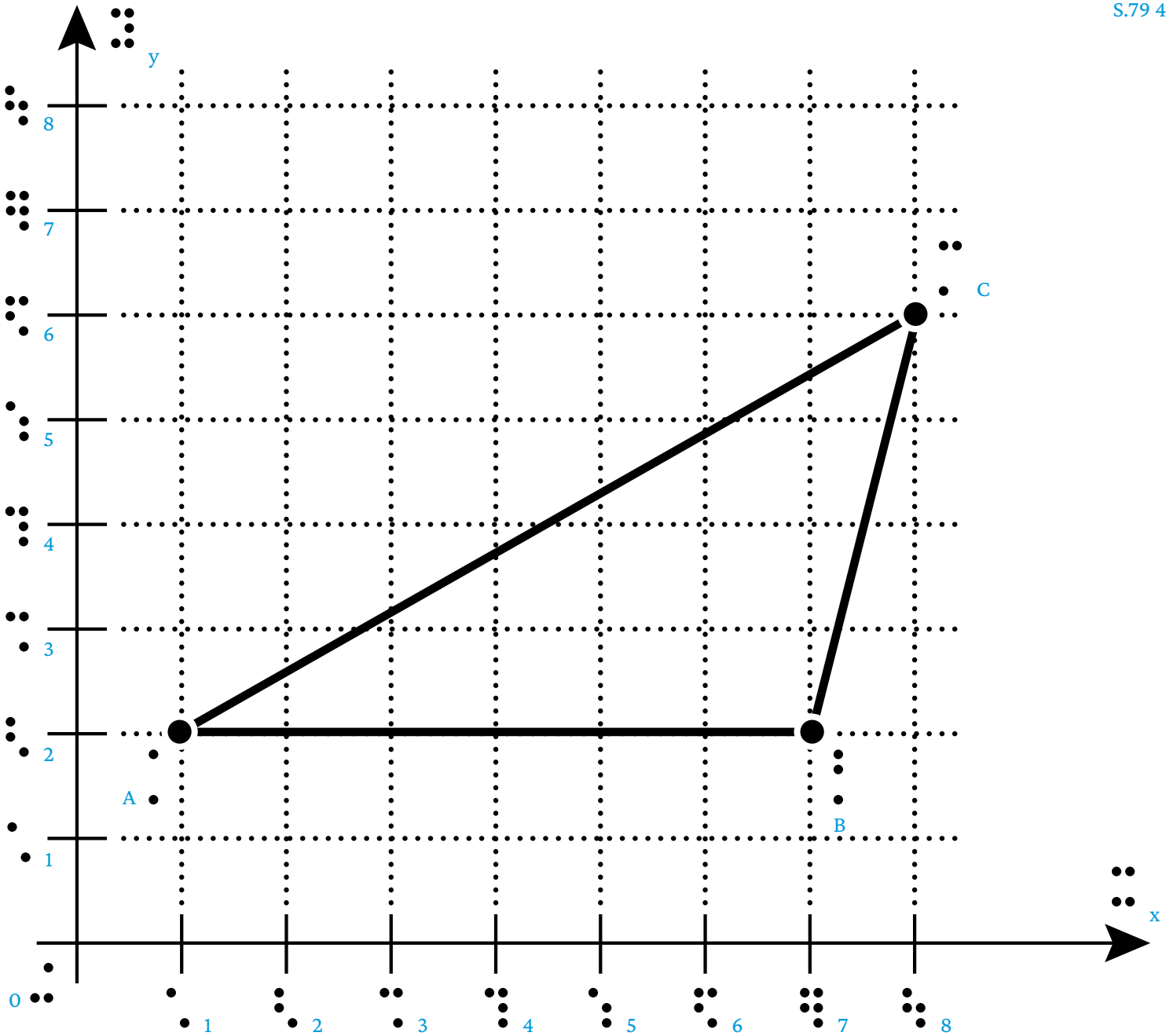
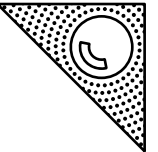

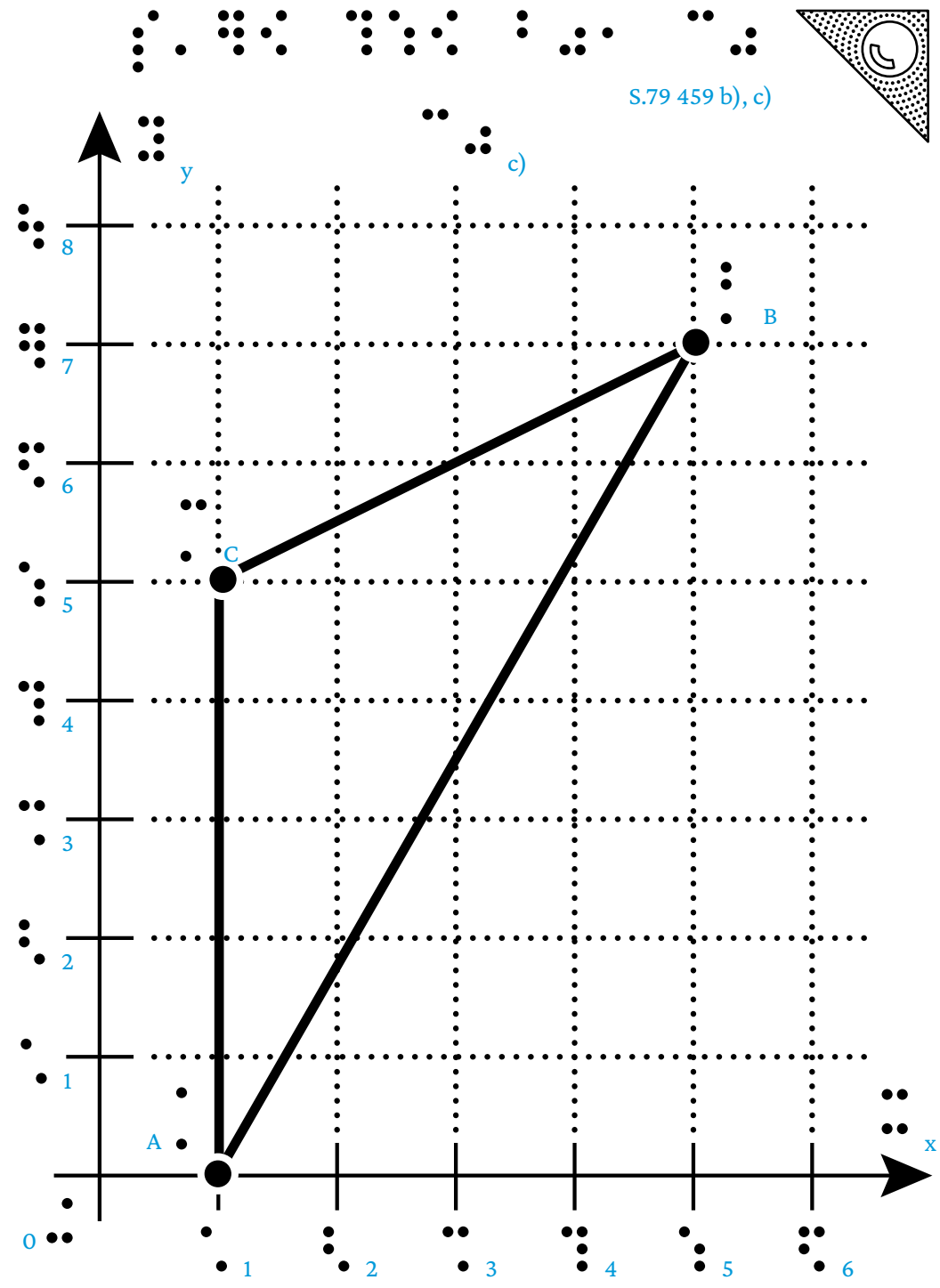
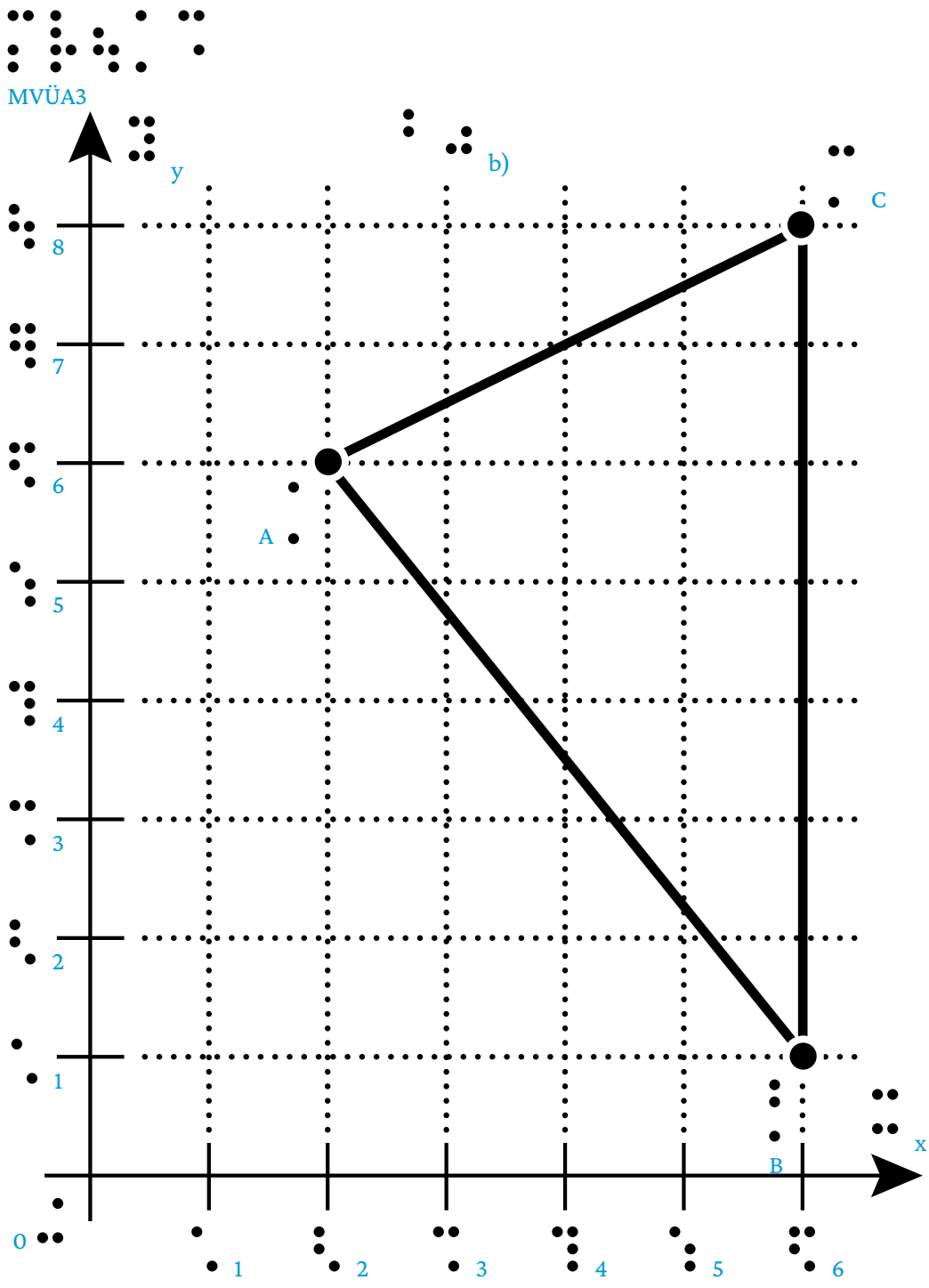

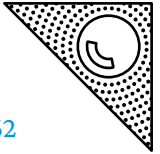

a)

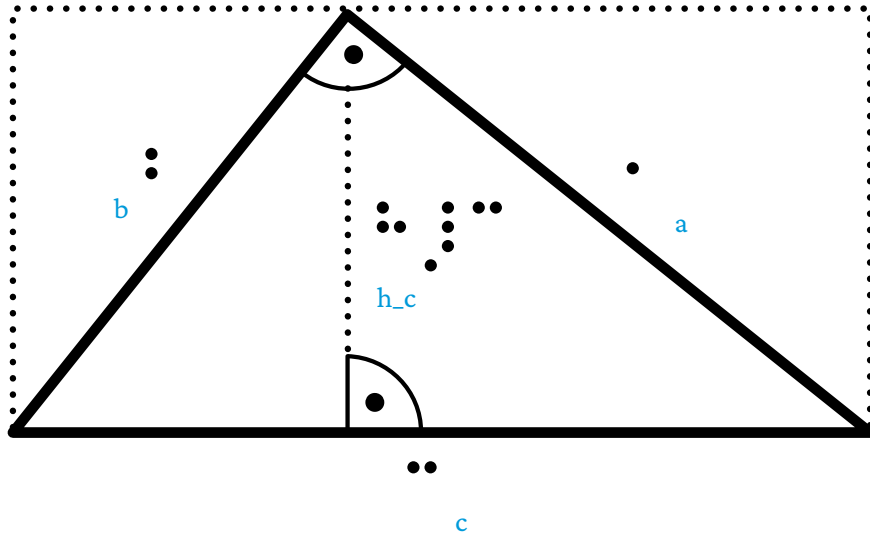

b)

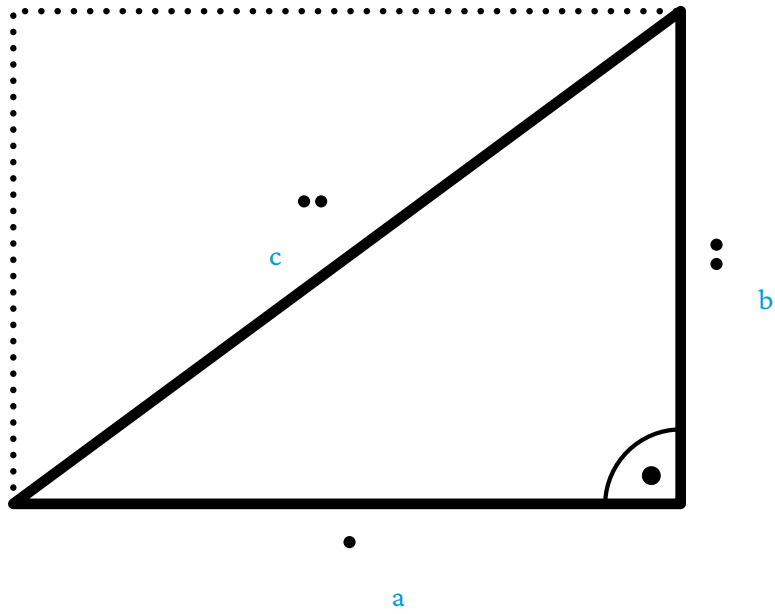

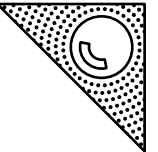

Grundriss

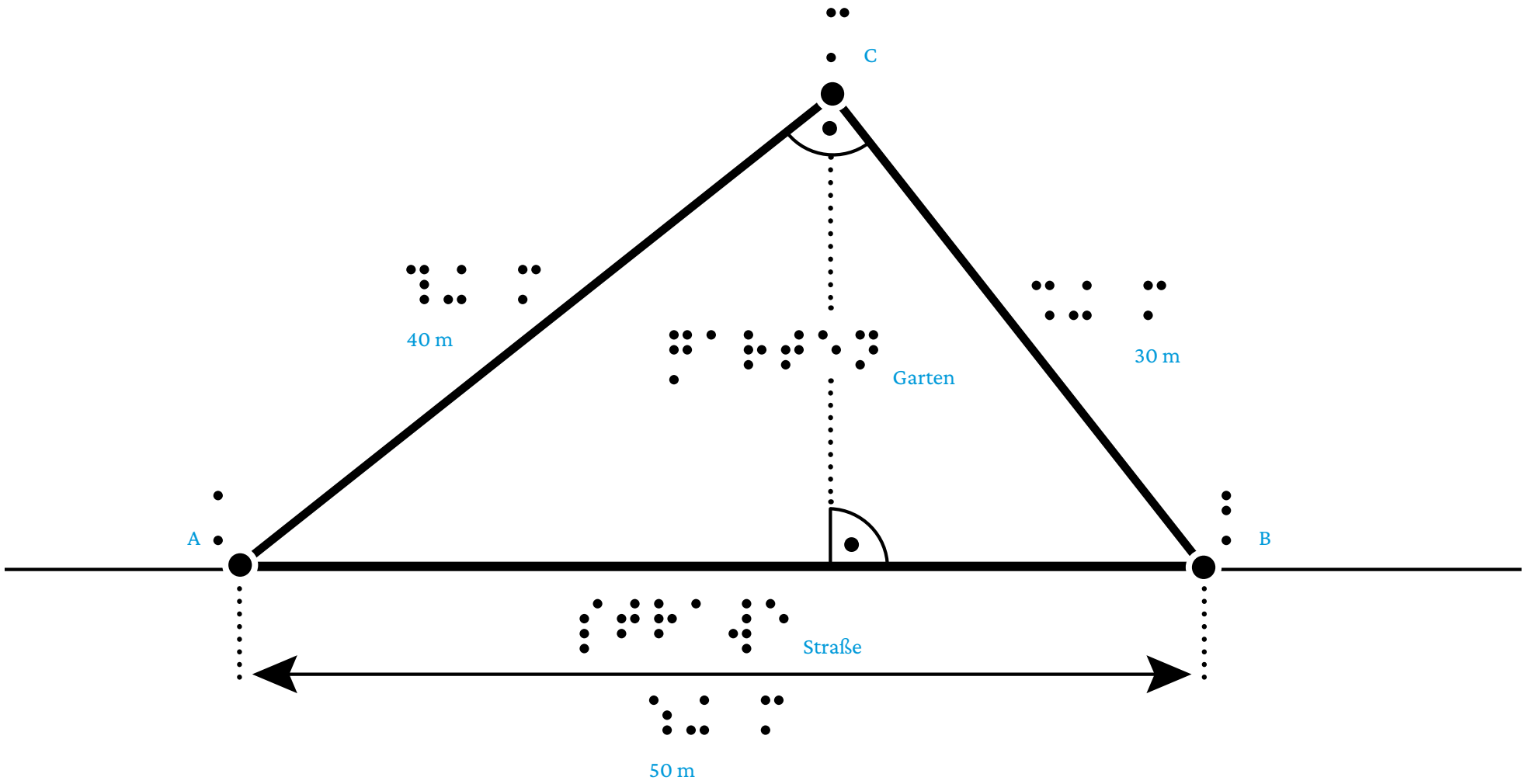

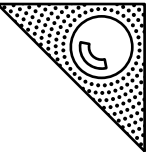

Grundriss

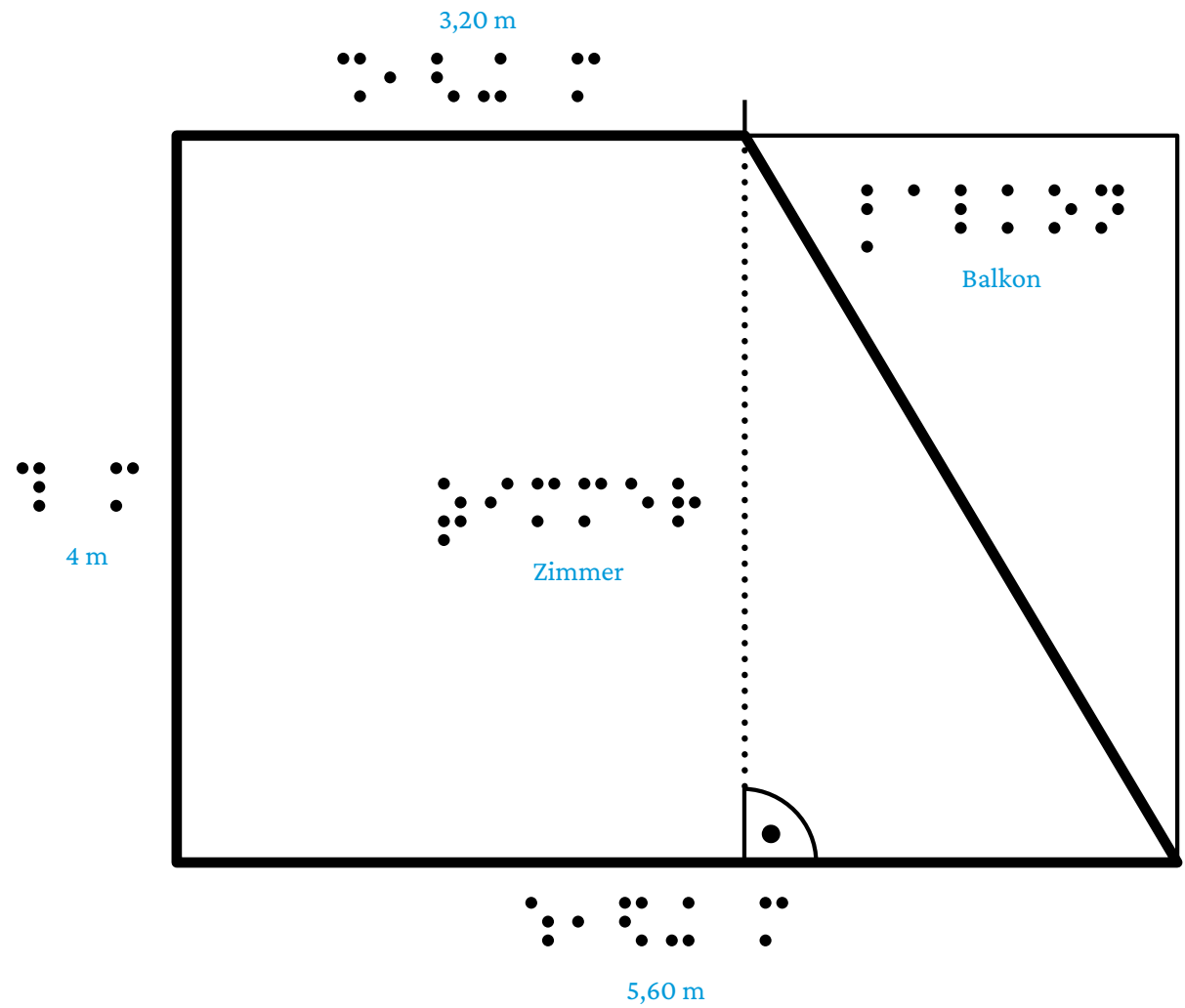

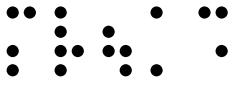

MVÜA3

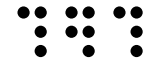
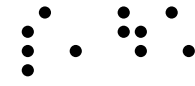

S.81 474

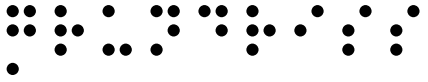
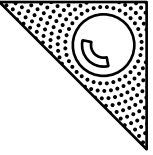

Grundriss

3 m

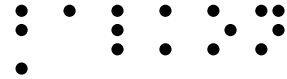
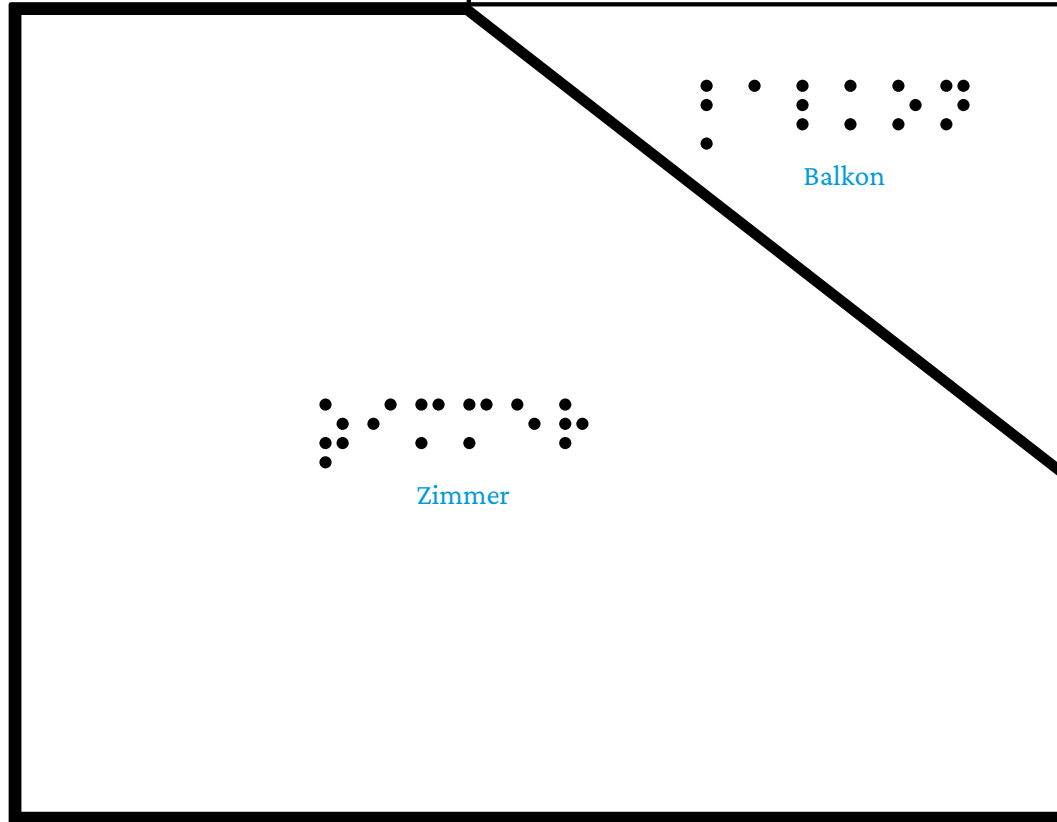
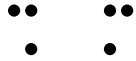

Balkon

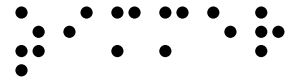

Zimmer

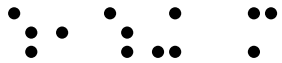

5,50 m



2,50 m



7 m

MVÜA3
a)

S.81 475

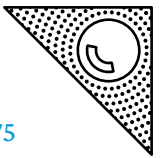

4,8 m

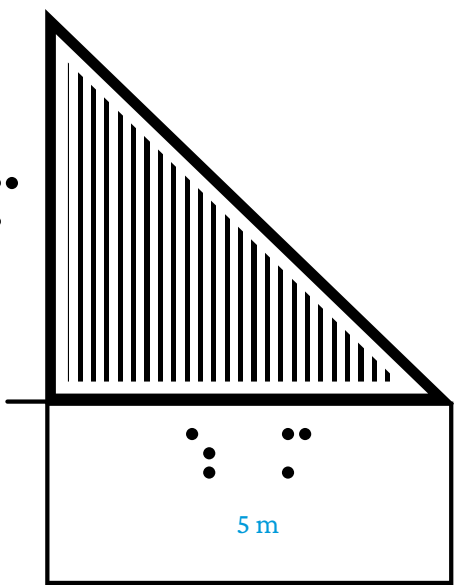

5 m

b)

5,2 m

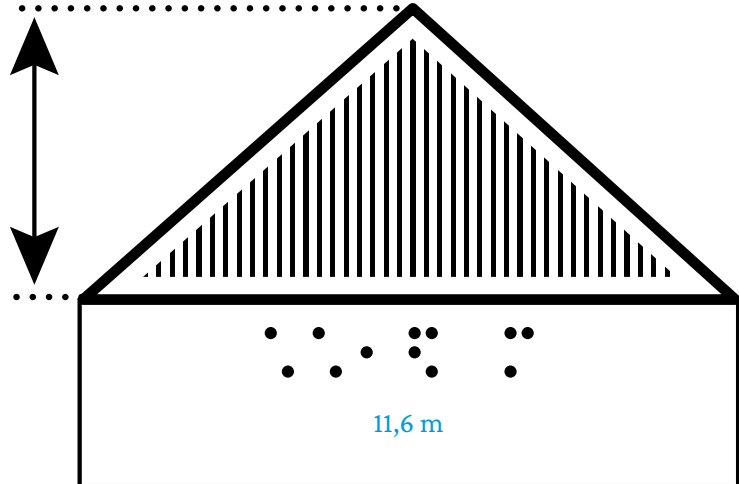

11,6 m

c)

9,2 m

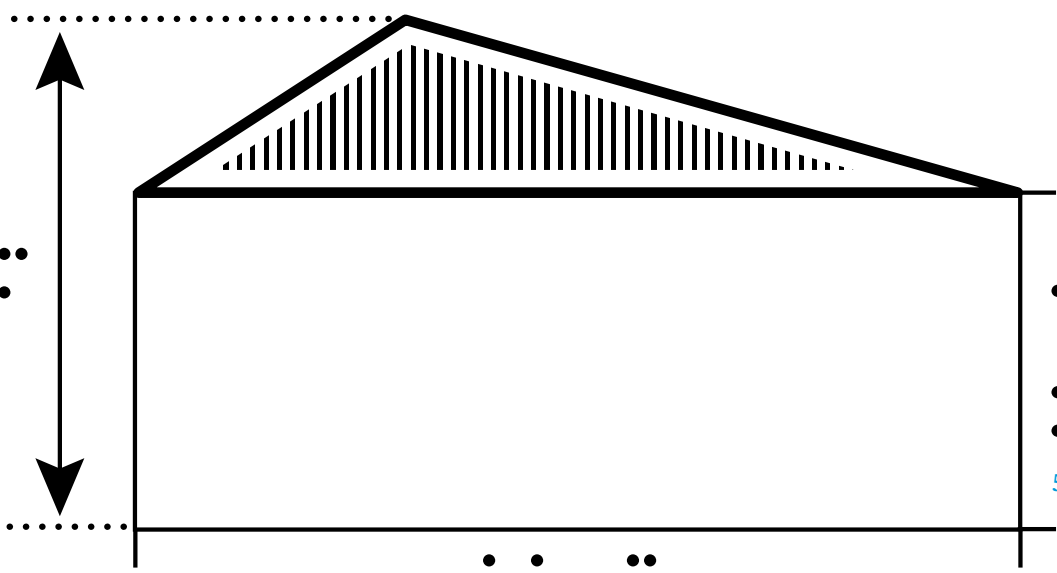

5,8 m

15 m

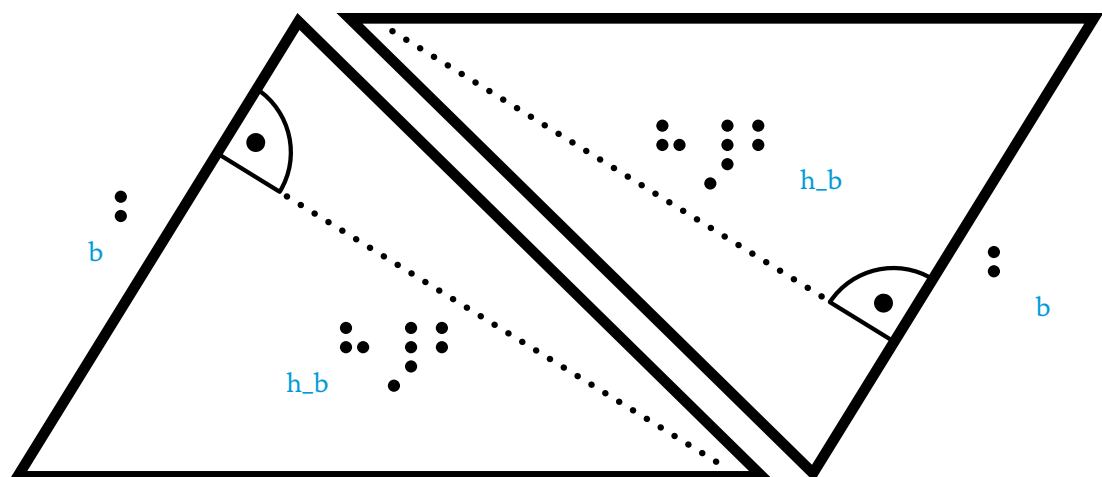
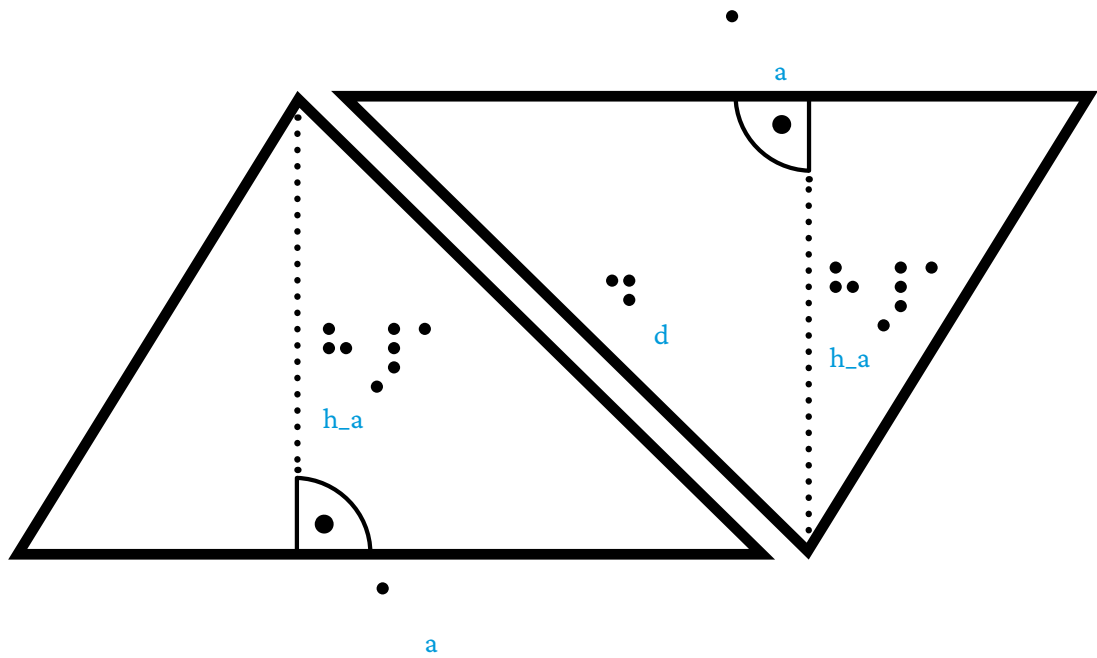
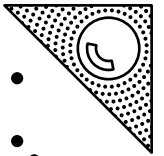
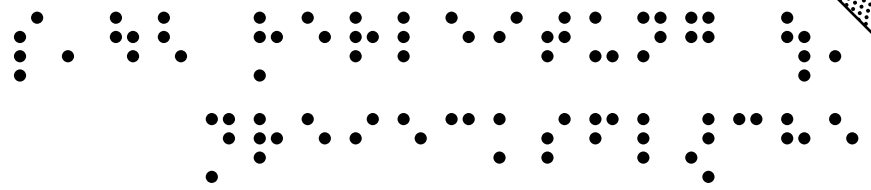

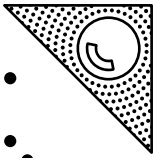
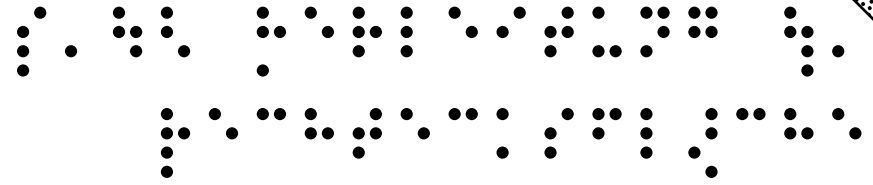
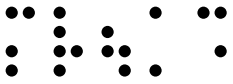

a

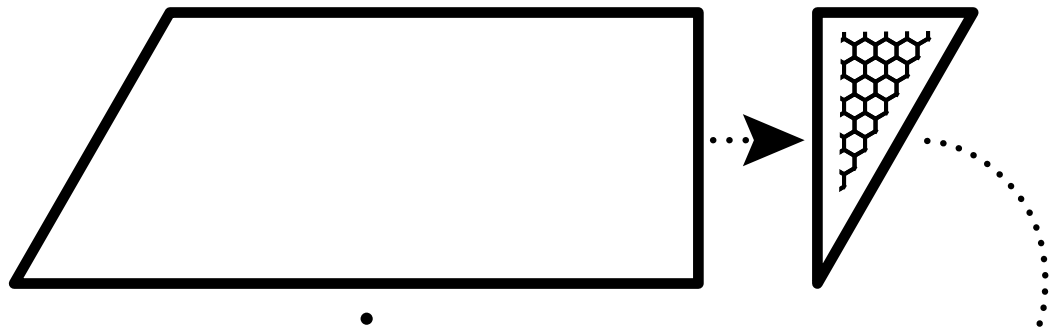

a

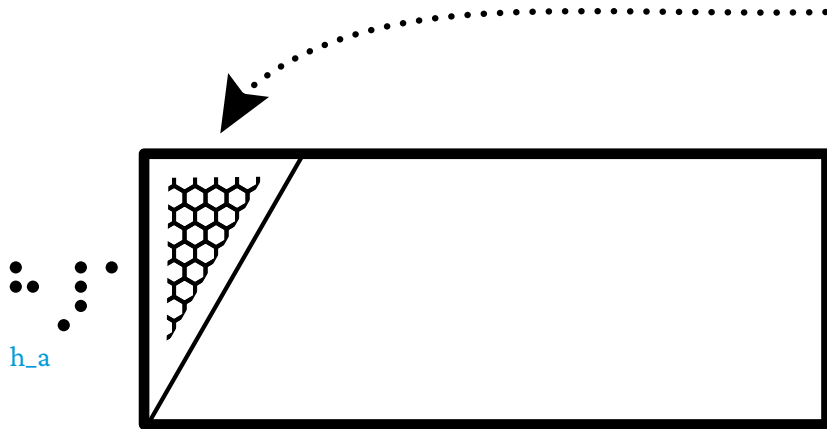

a

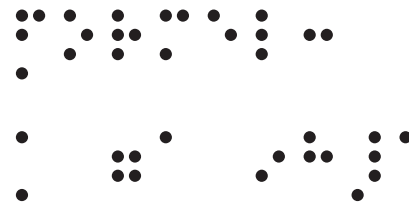
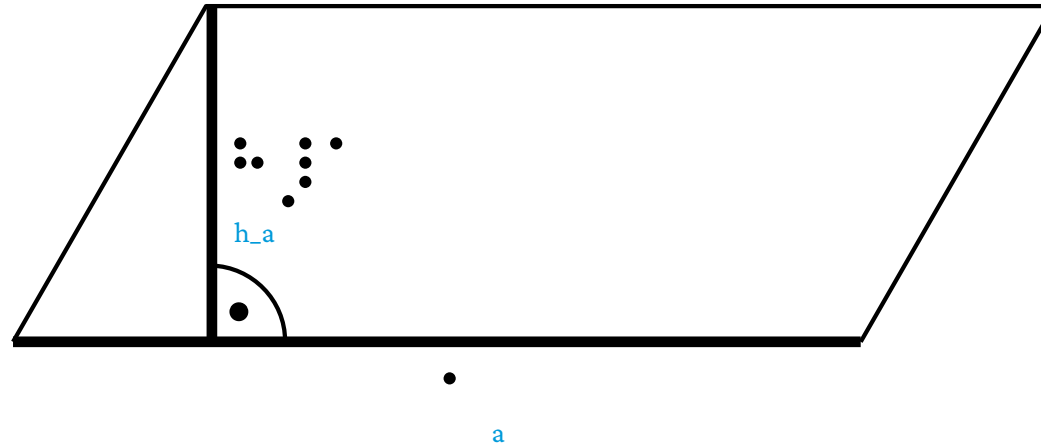
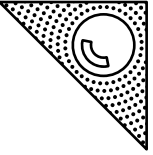

Formel:
 $A = a \cdot h_a$

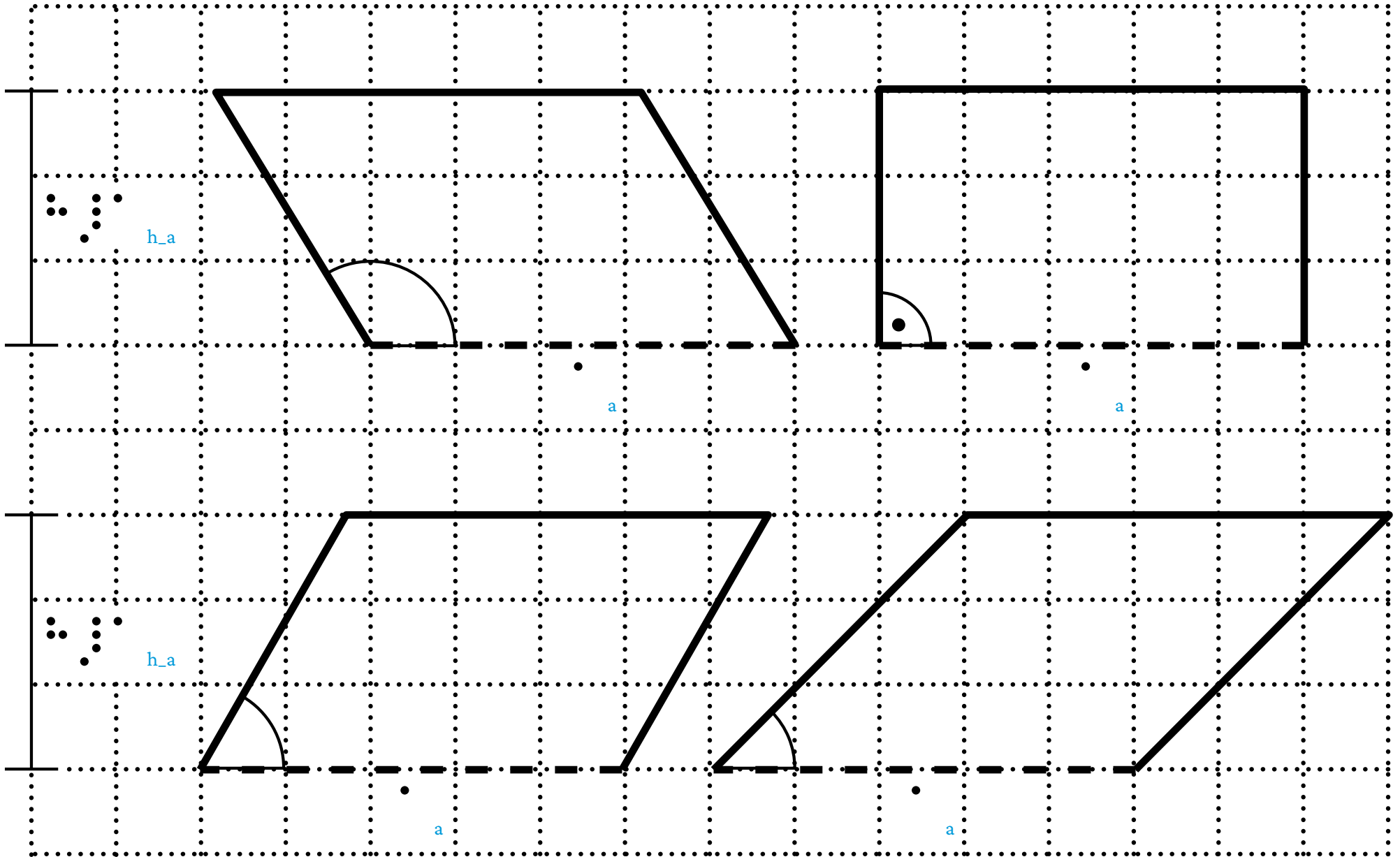
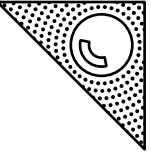

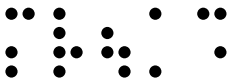

MVÜA3



S.83 482

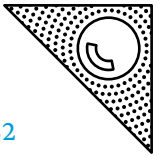

a)

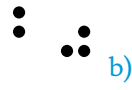

b)

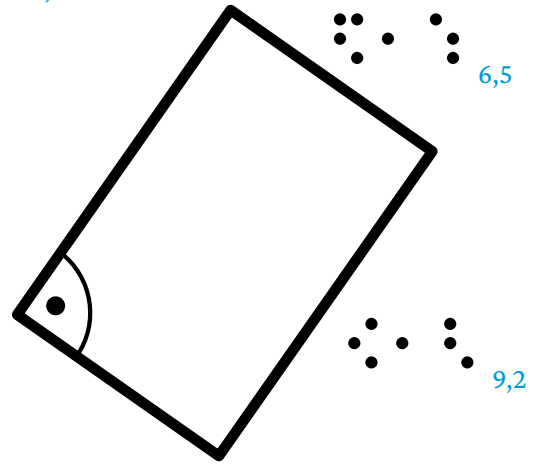
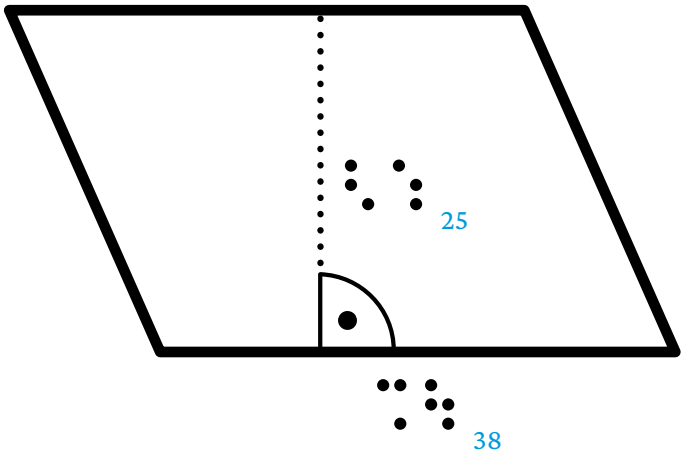

c)

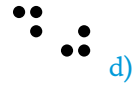

d)

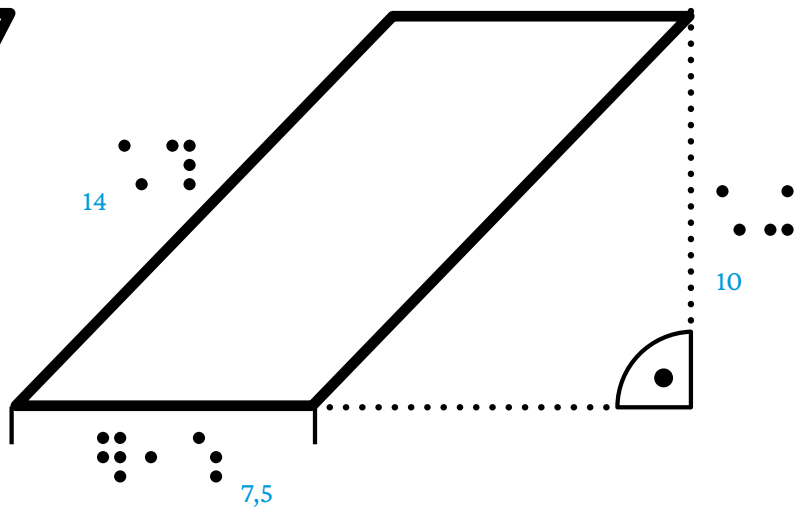
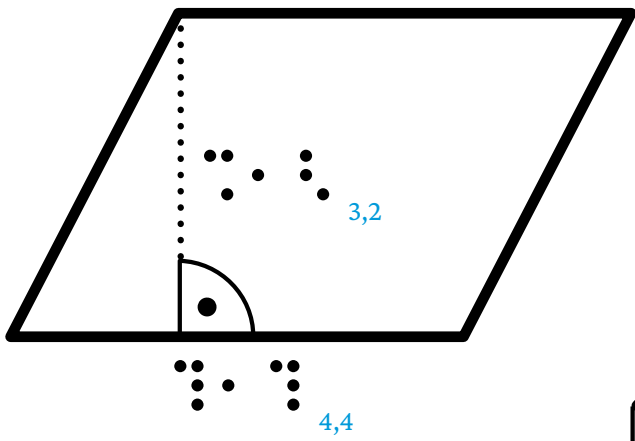

e)

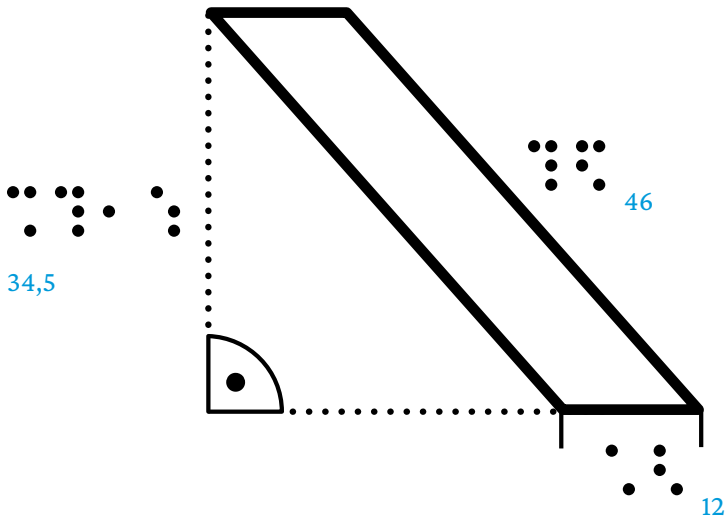

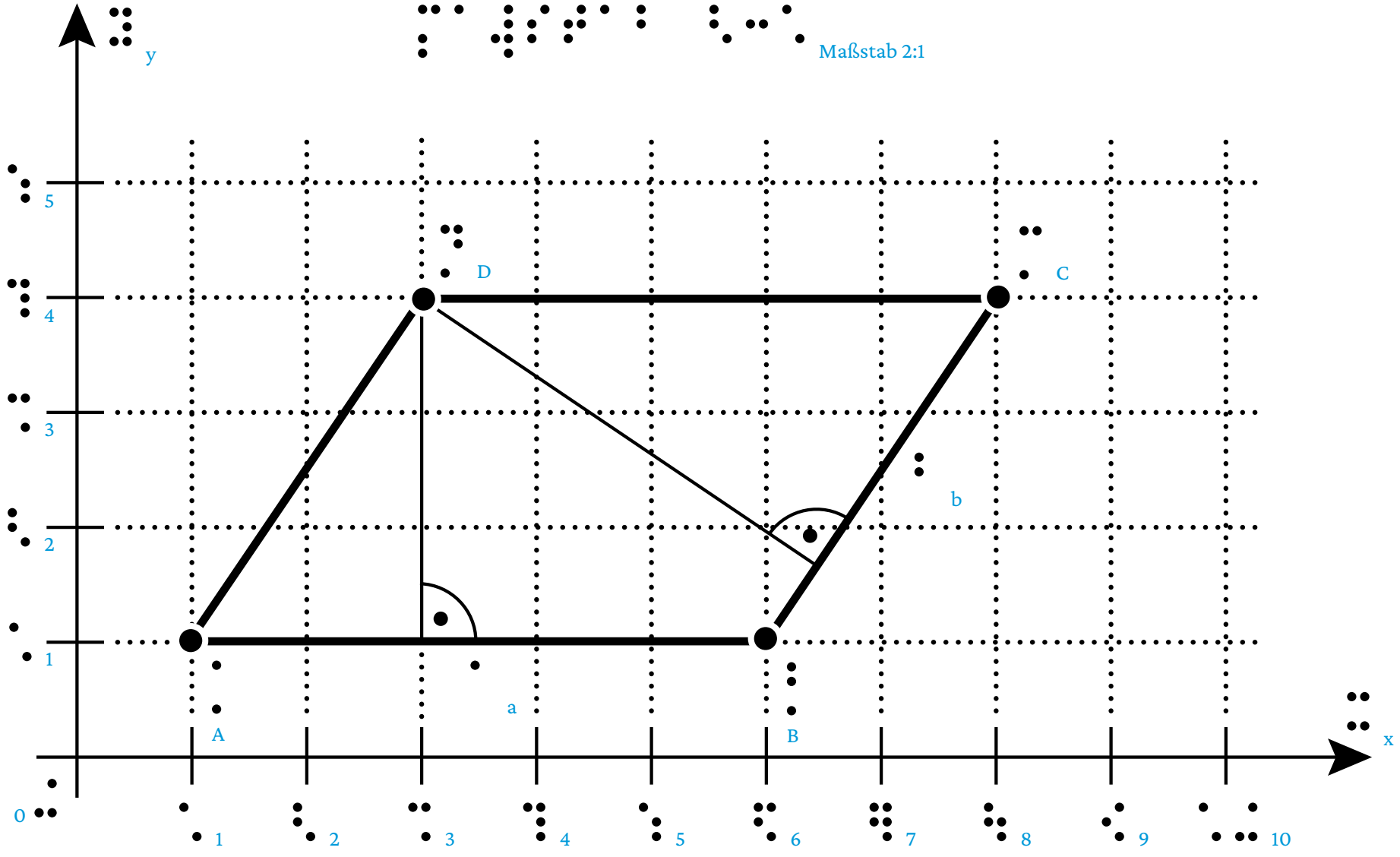
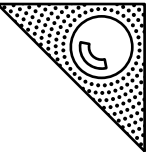

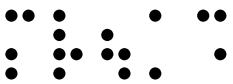

MVÜA3

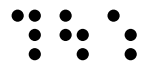
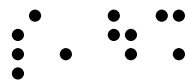

S.83 485

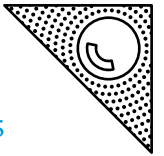

a)

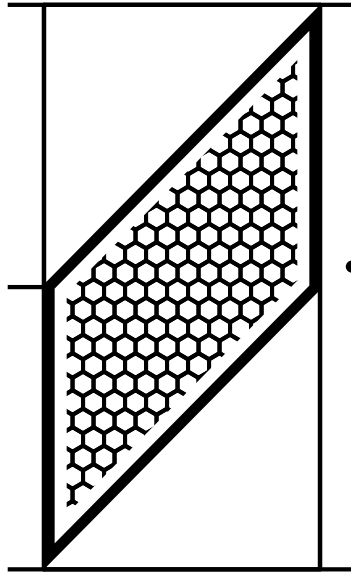

10



5



b)

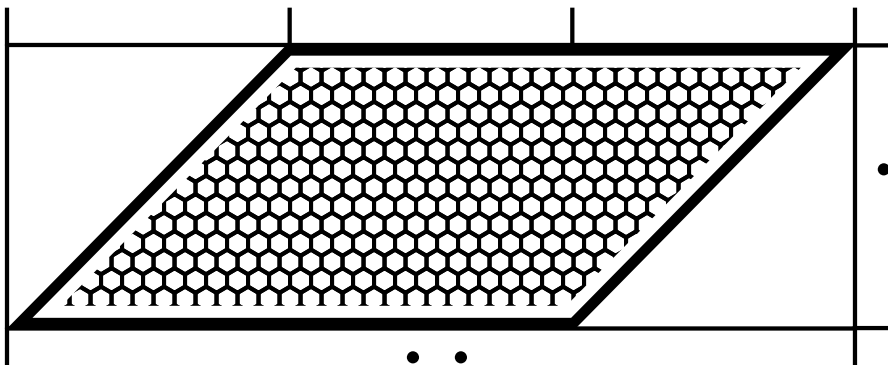

5



15



c)

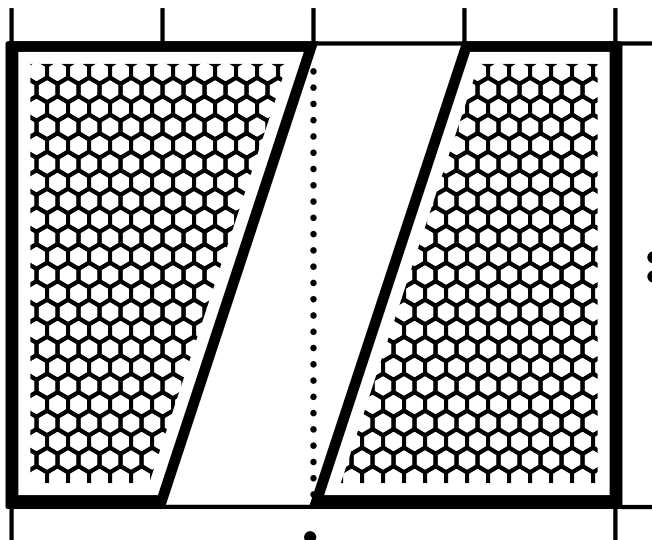

6



8

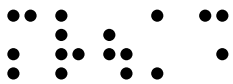

MVÜA3



S.83 486

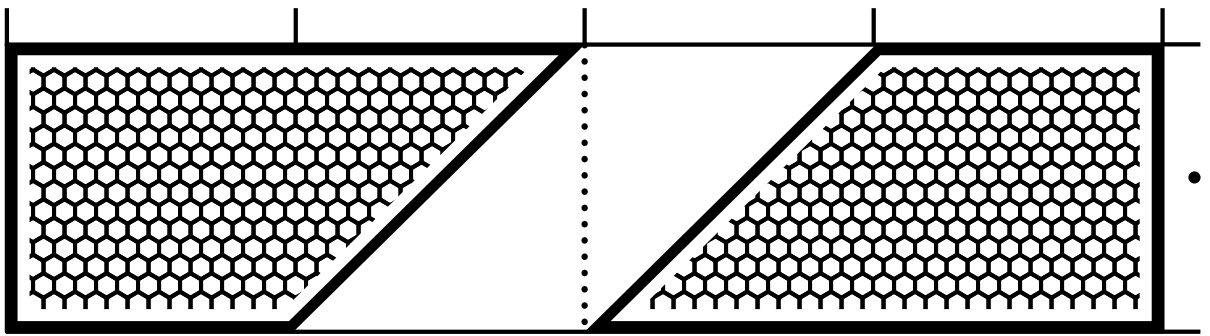
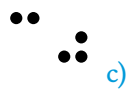
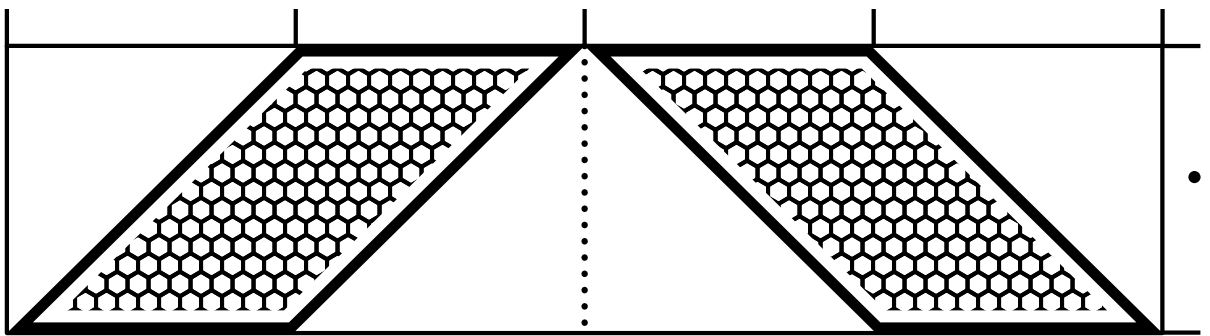
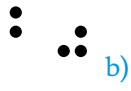
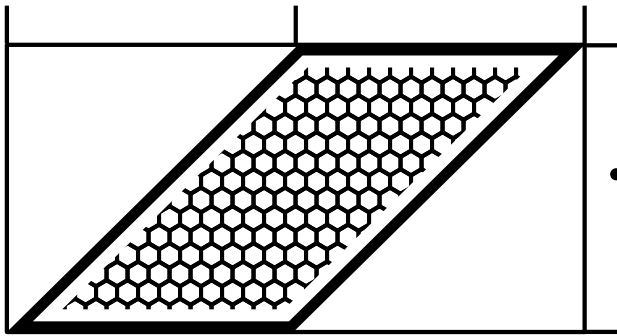
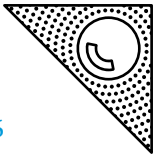

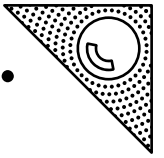

S.85 Einführungsbeispiel

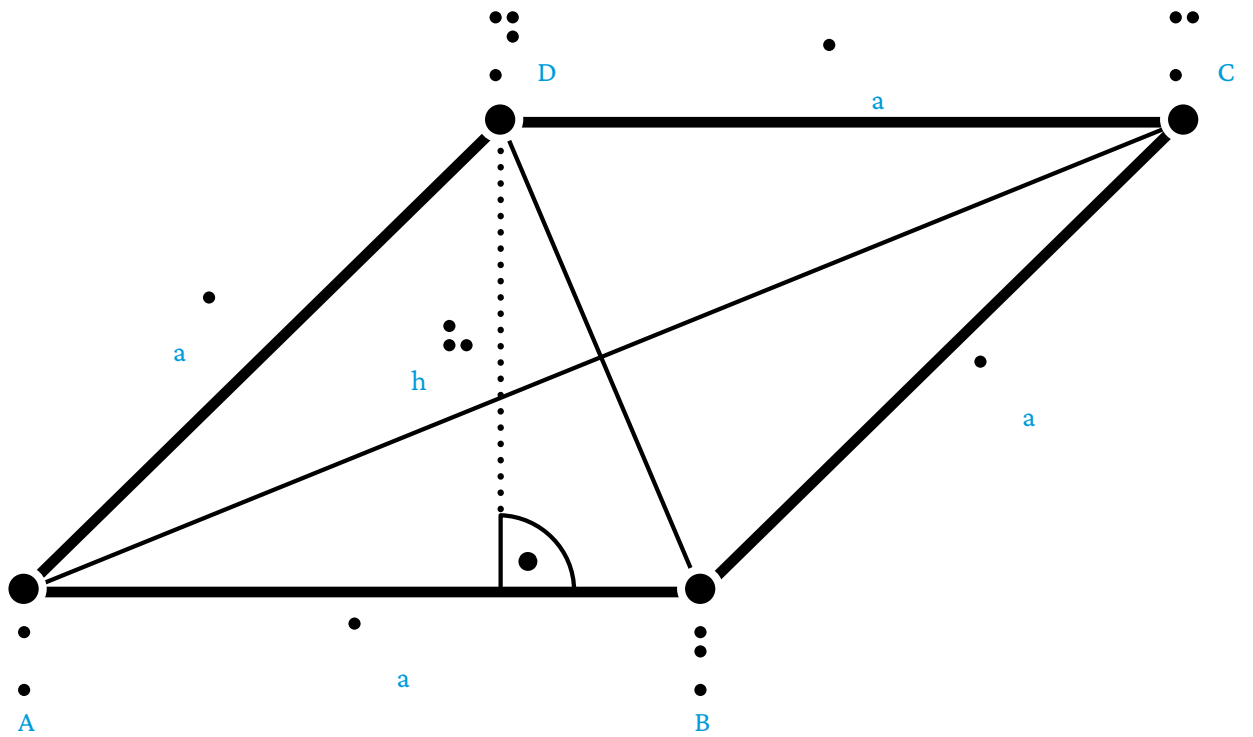
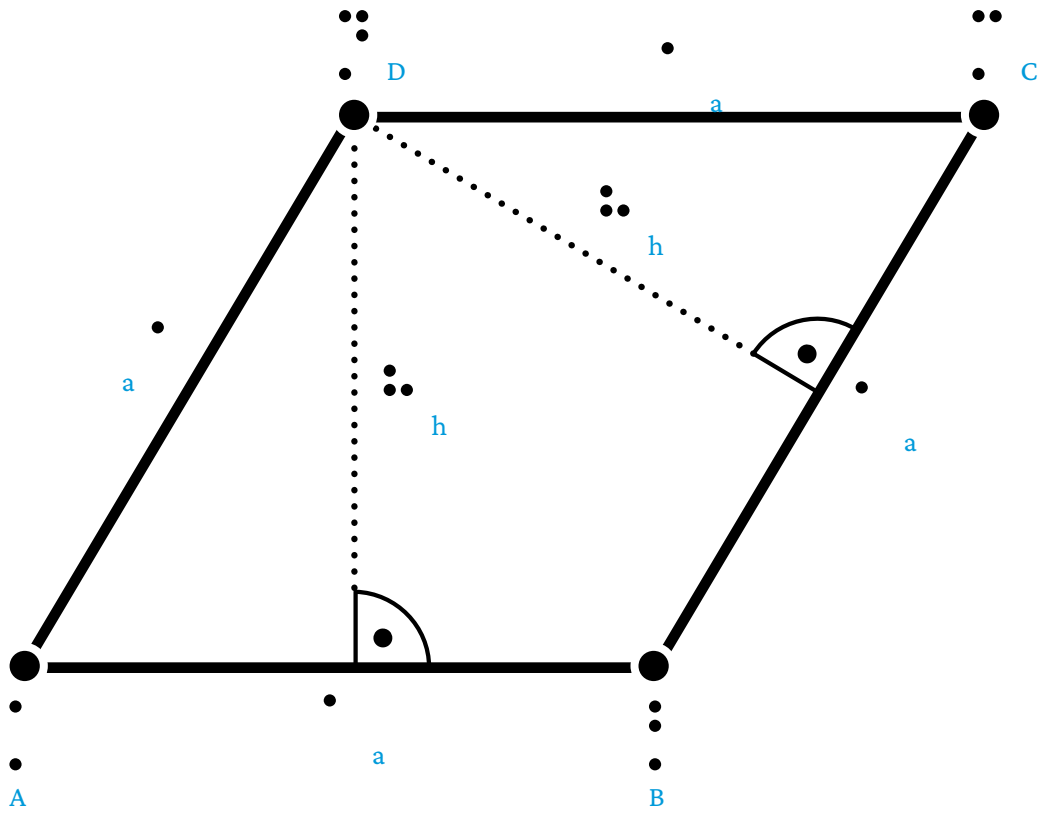

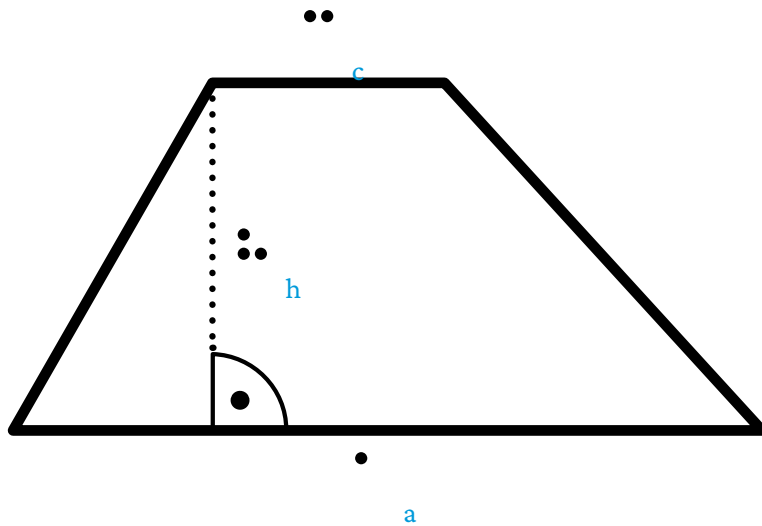
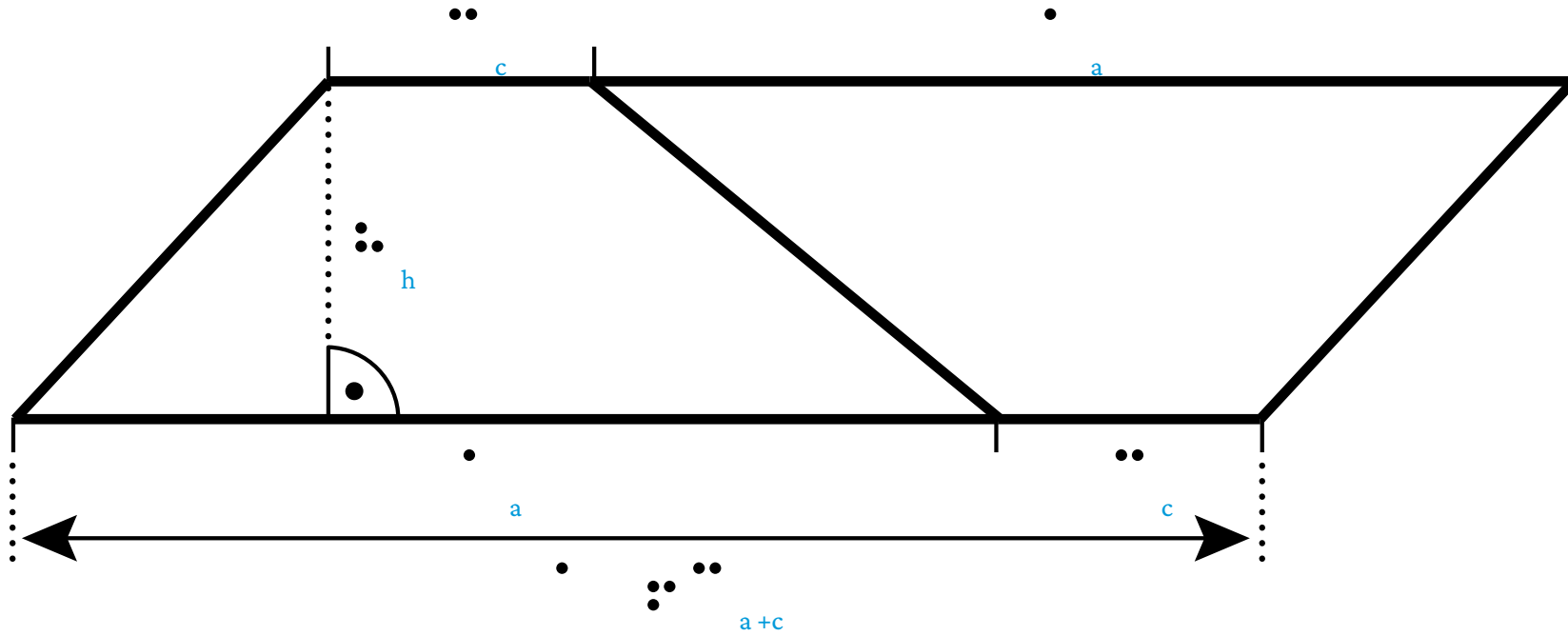
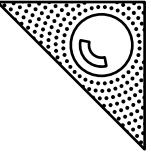

Braille text describing the diagram and formula

Formel:
 $A = ((a + c) * h) / 2$

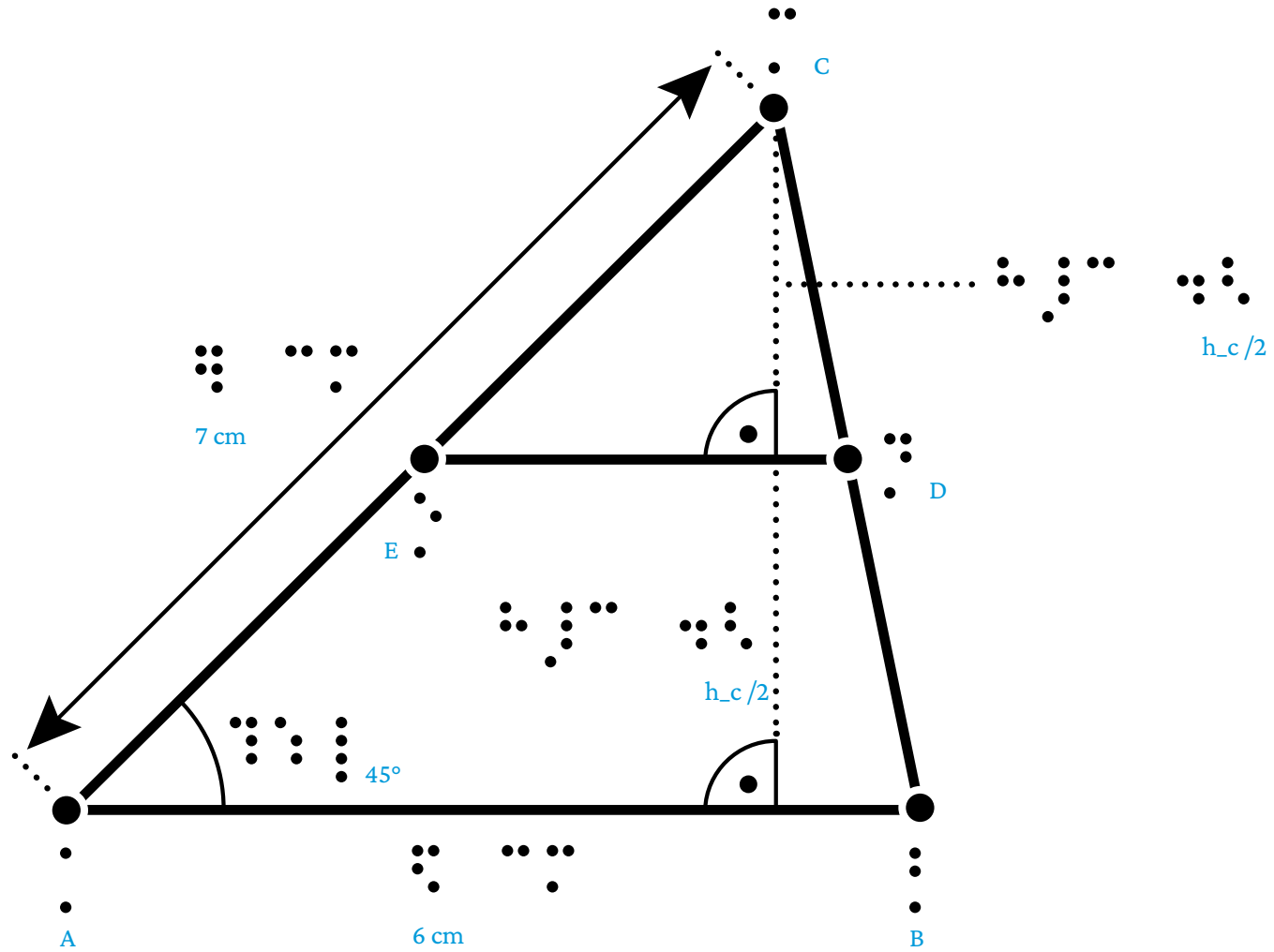
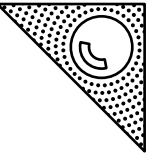

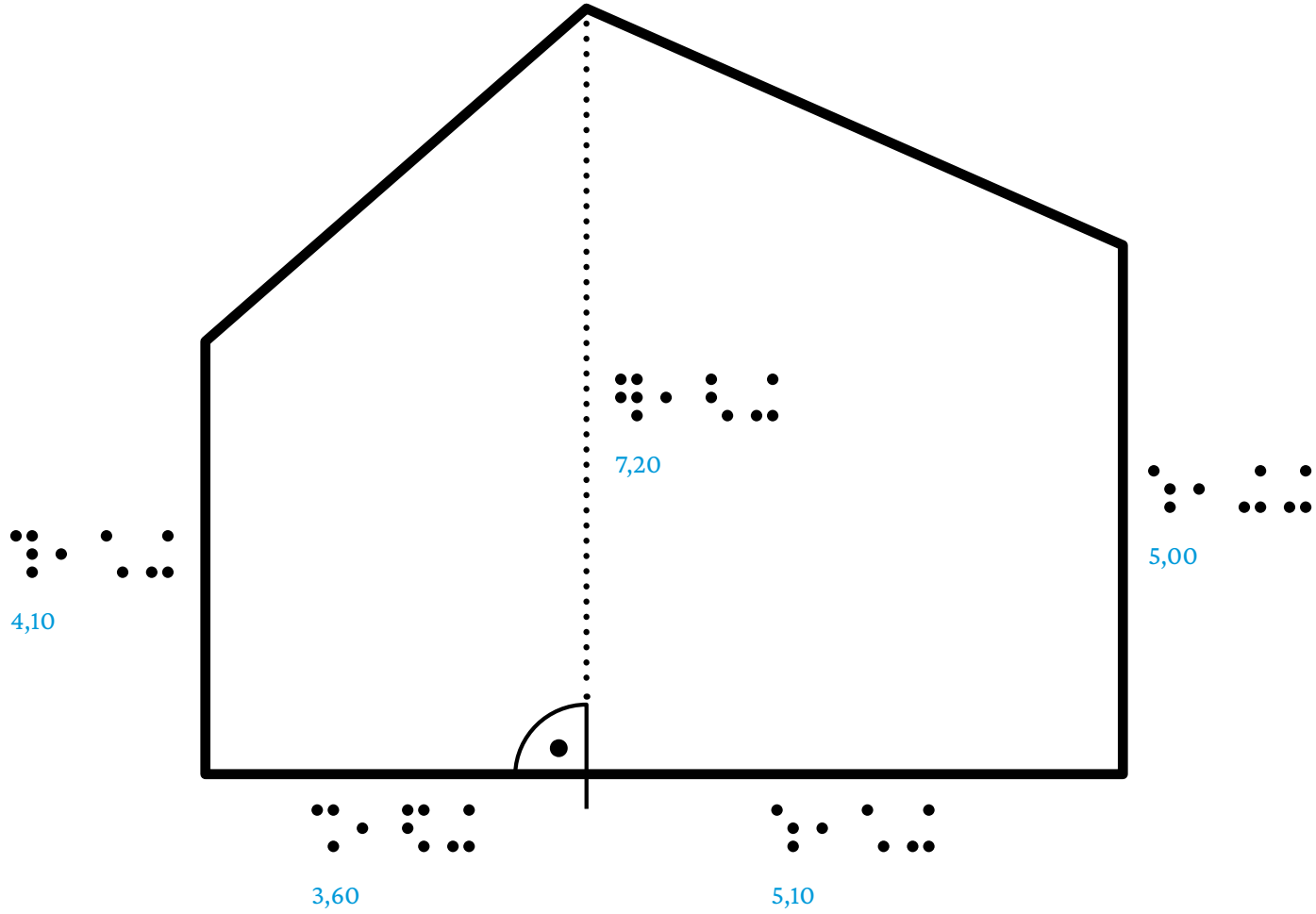
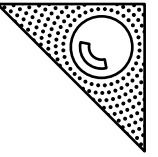

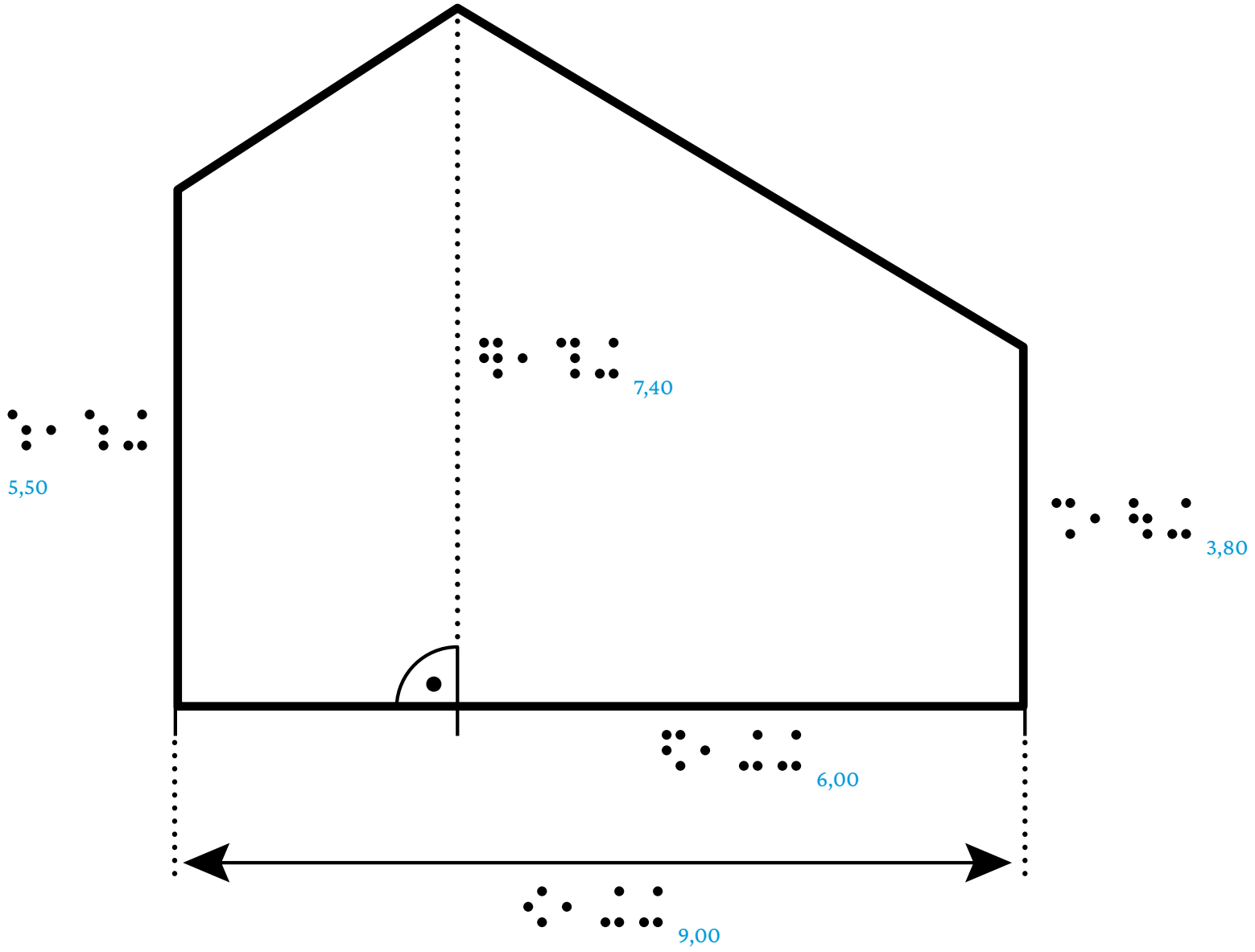
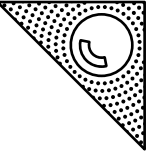

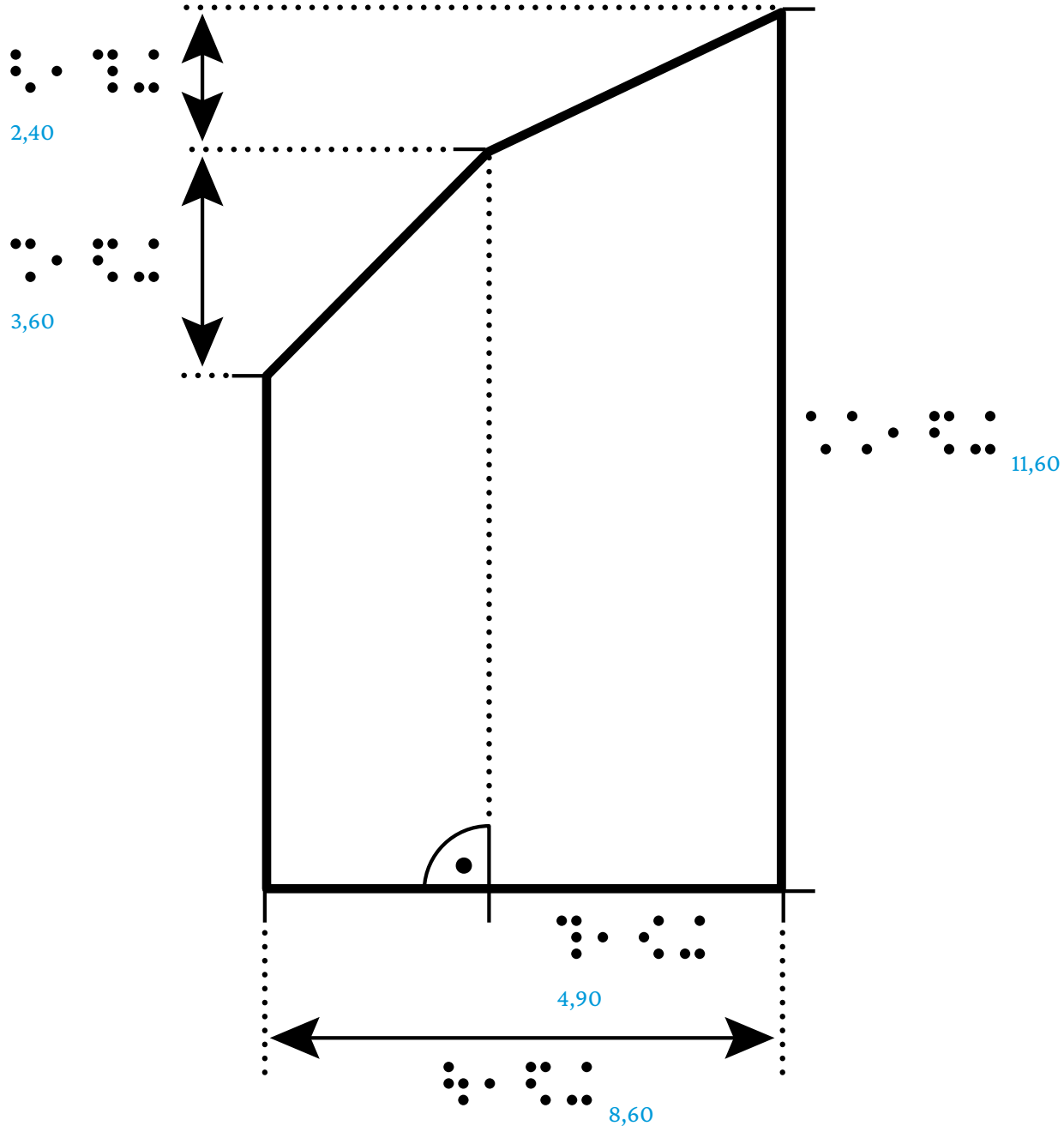
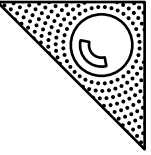

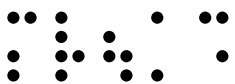

MVÜA3

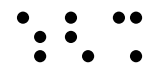
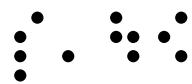

S.89 523

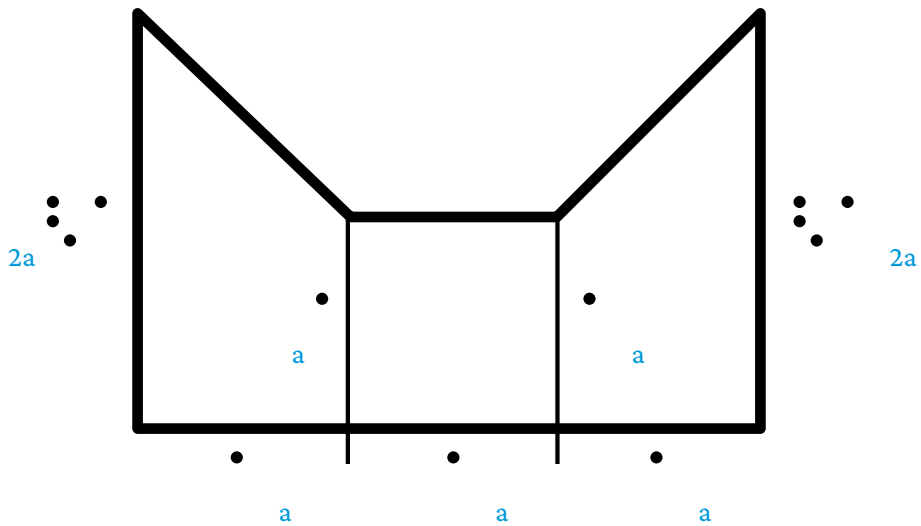
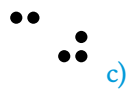
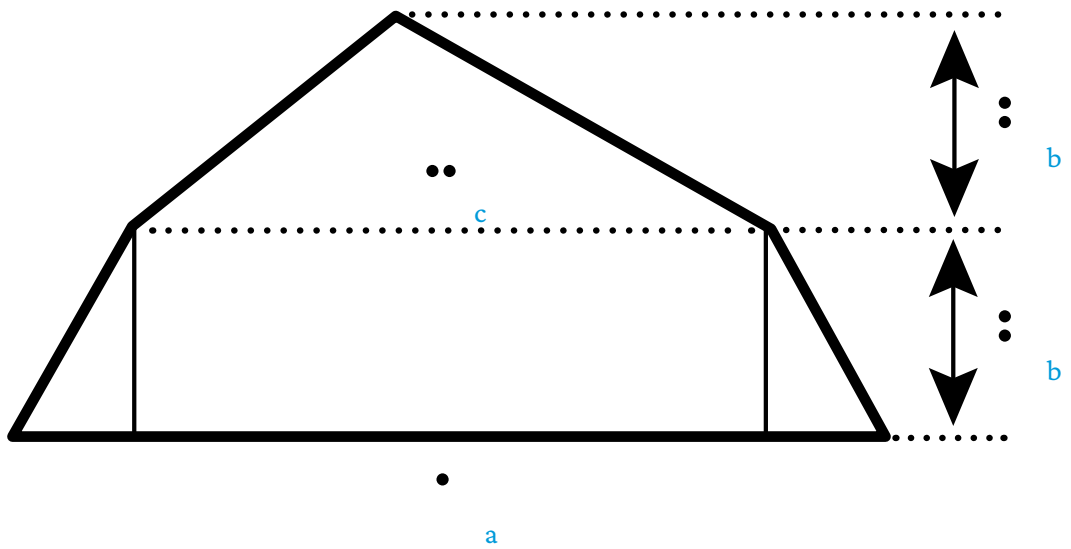
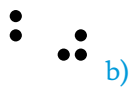
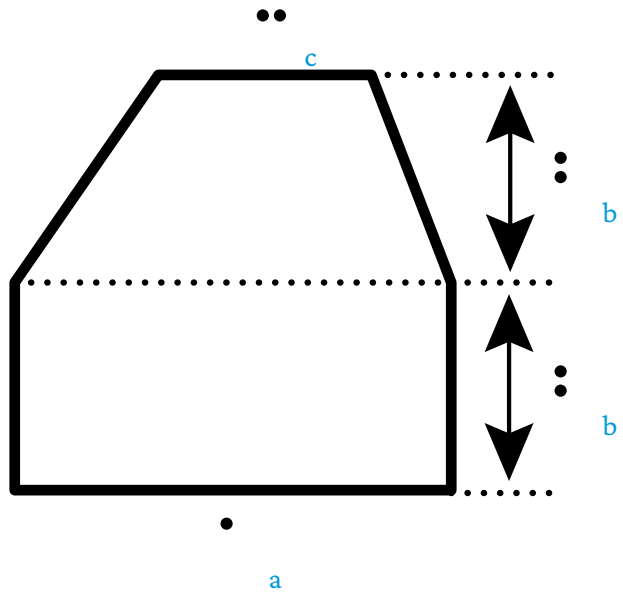
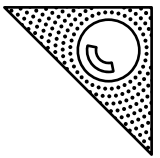

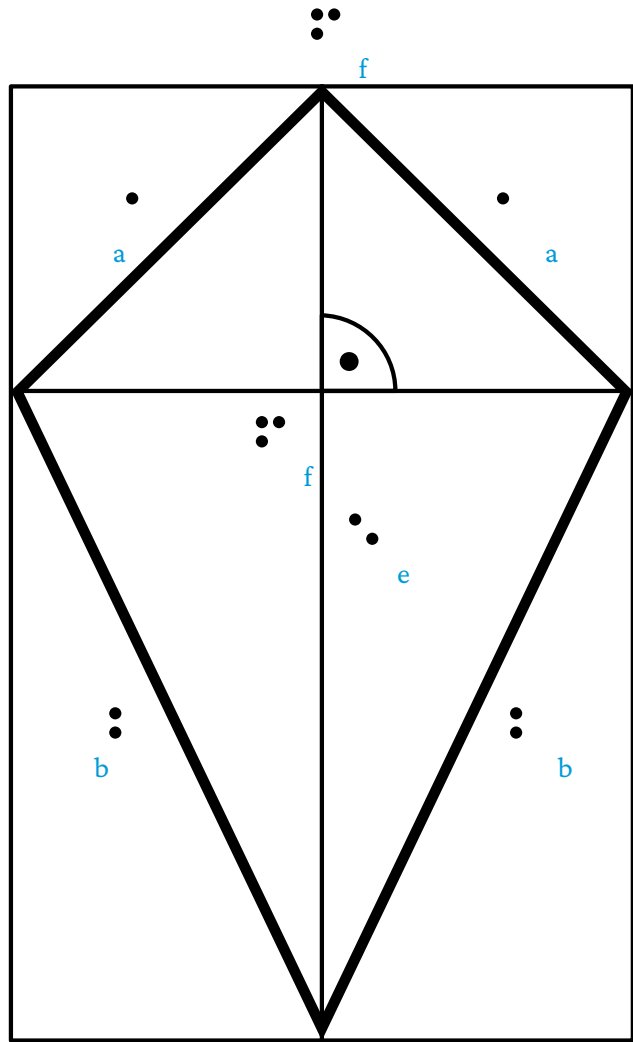

Deltoid

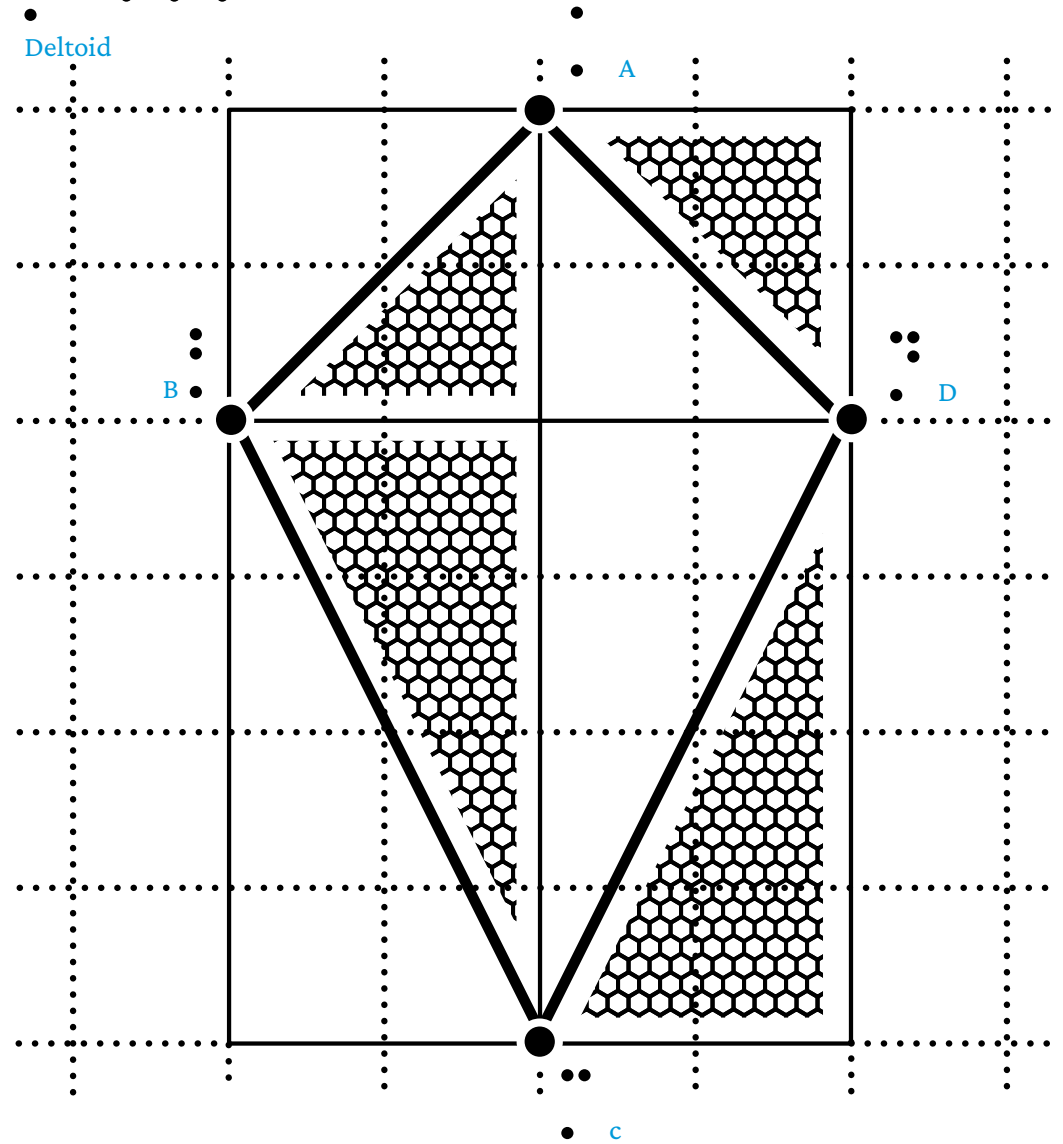

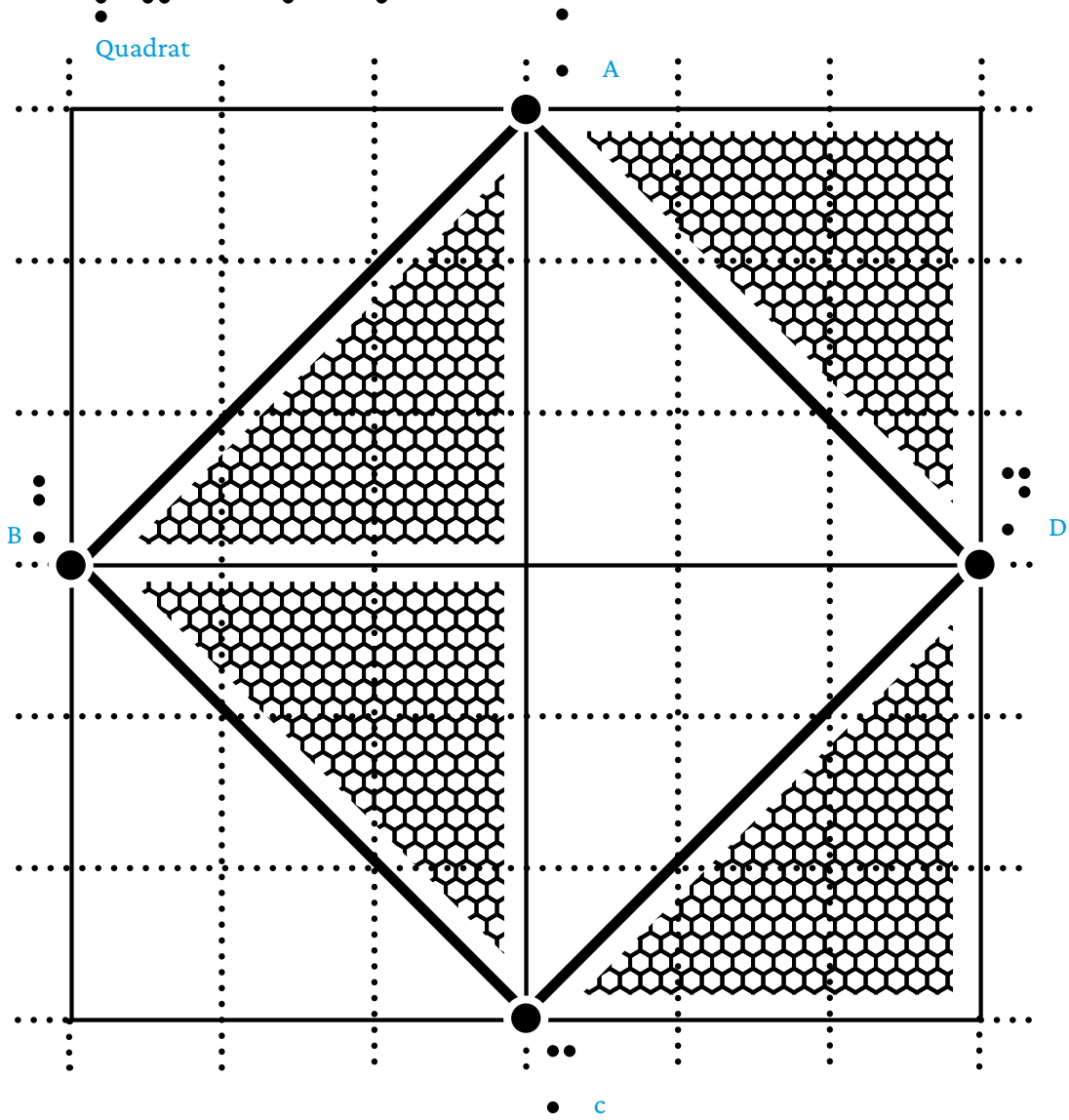
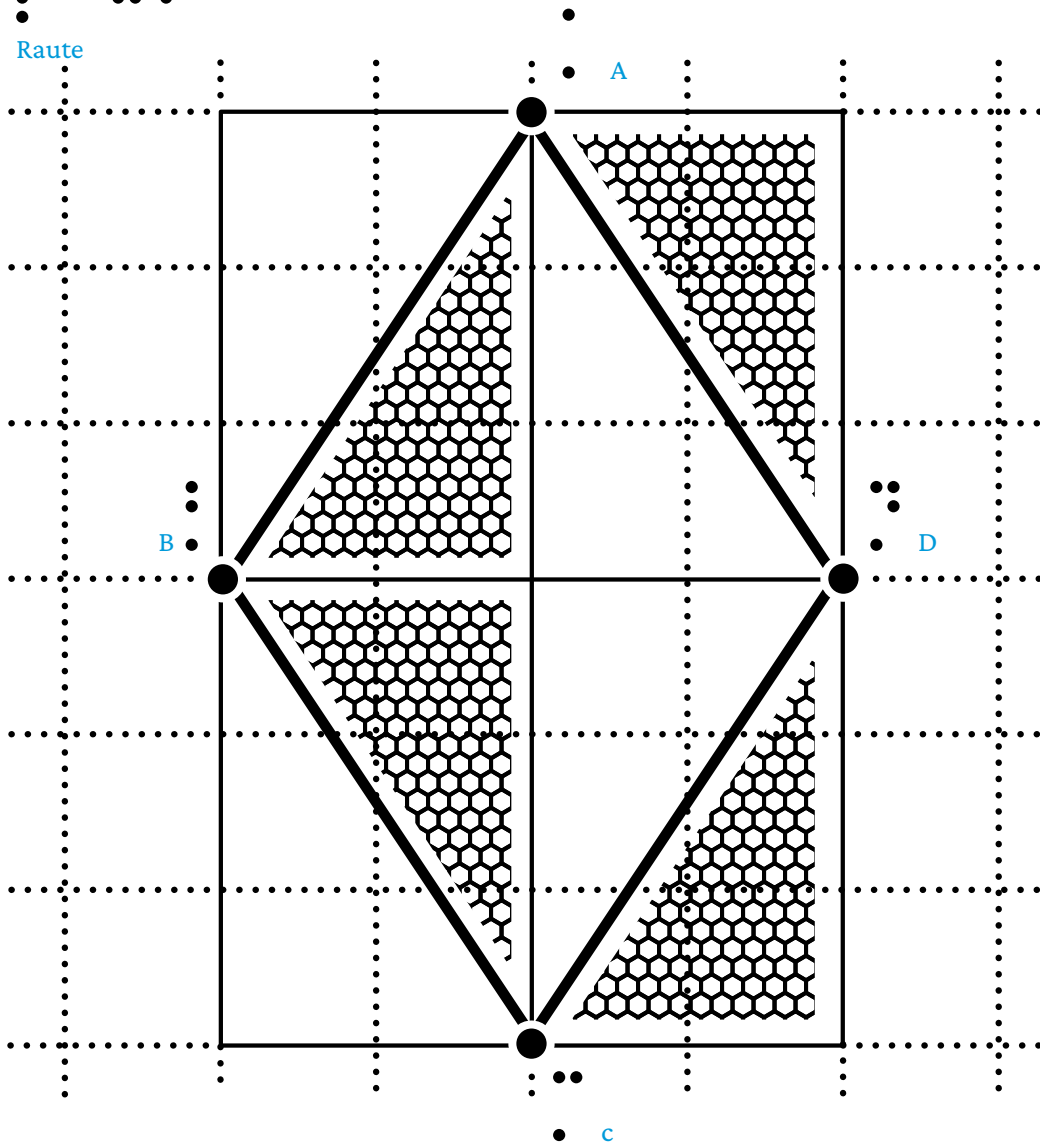

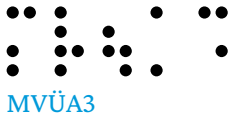

MVÜA3

S.91 532

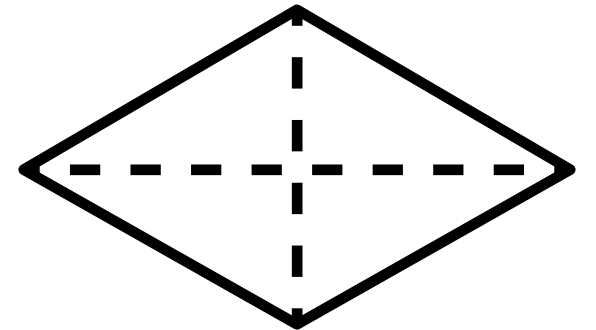
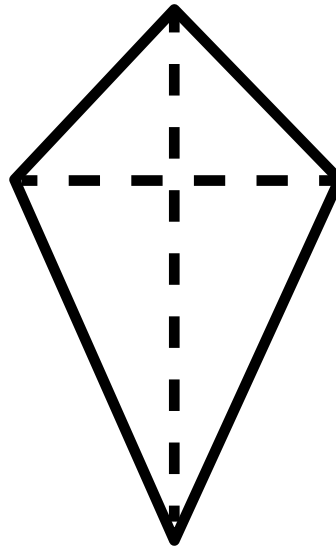
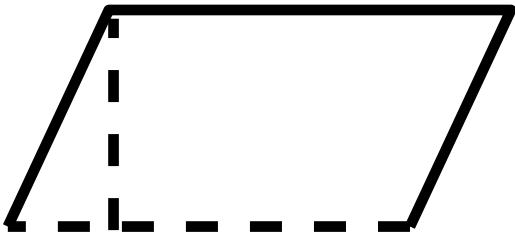
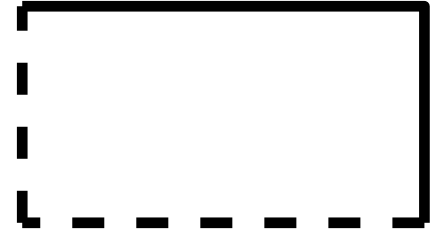
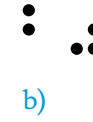
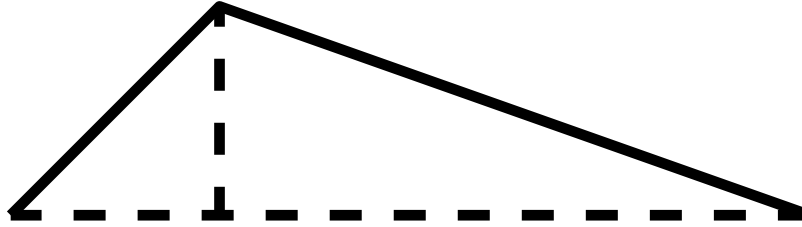
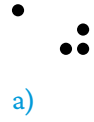
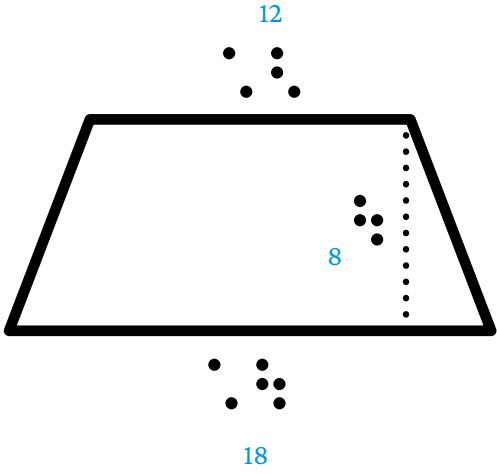
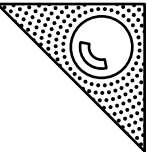

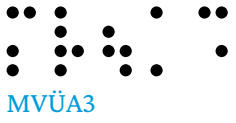

MVÜA3



a)

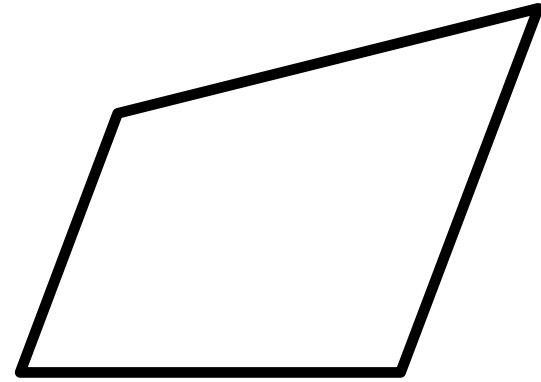
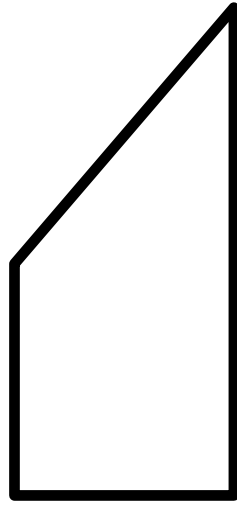
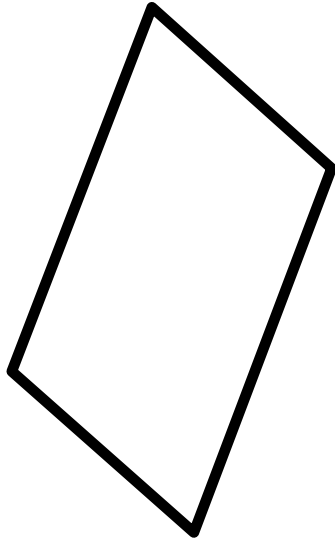

S.92 538

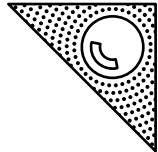

b)

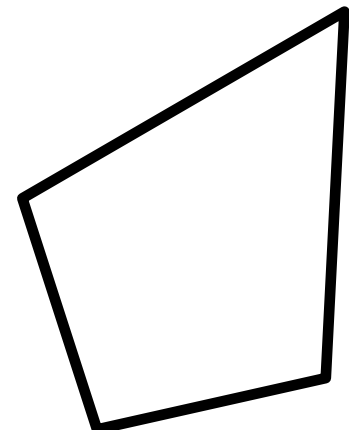
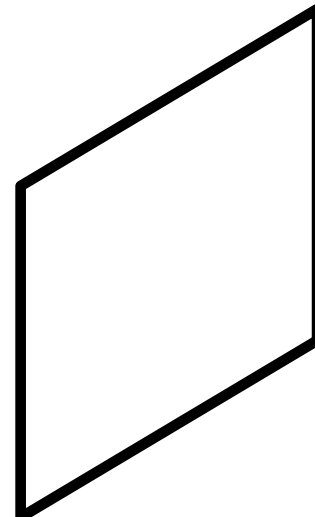
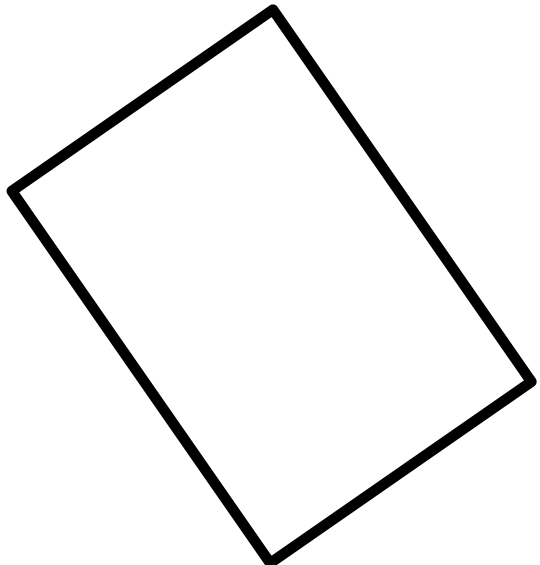

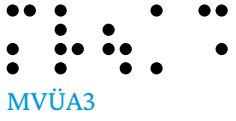

MVÜA3



1)



3)

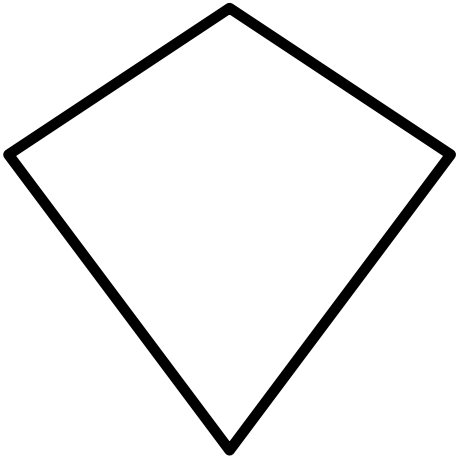

2)

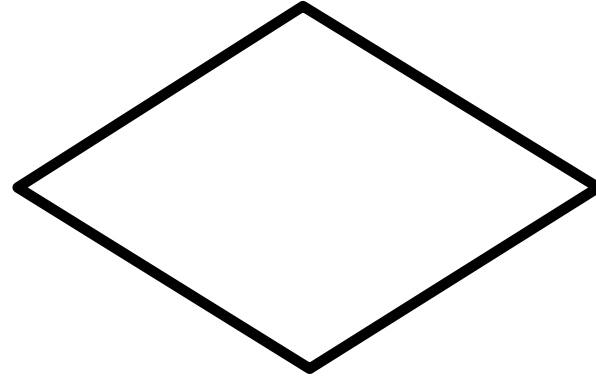

4)

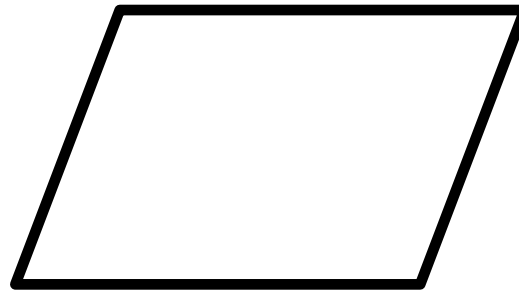

S.92 539

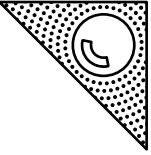

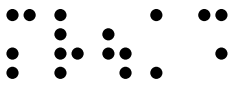

MVÜA3

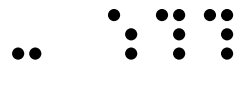
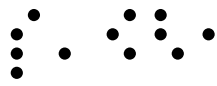

S.92, 93 542 - 544

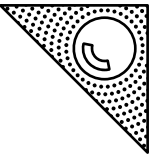

542

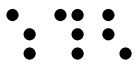
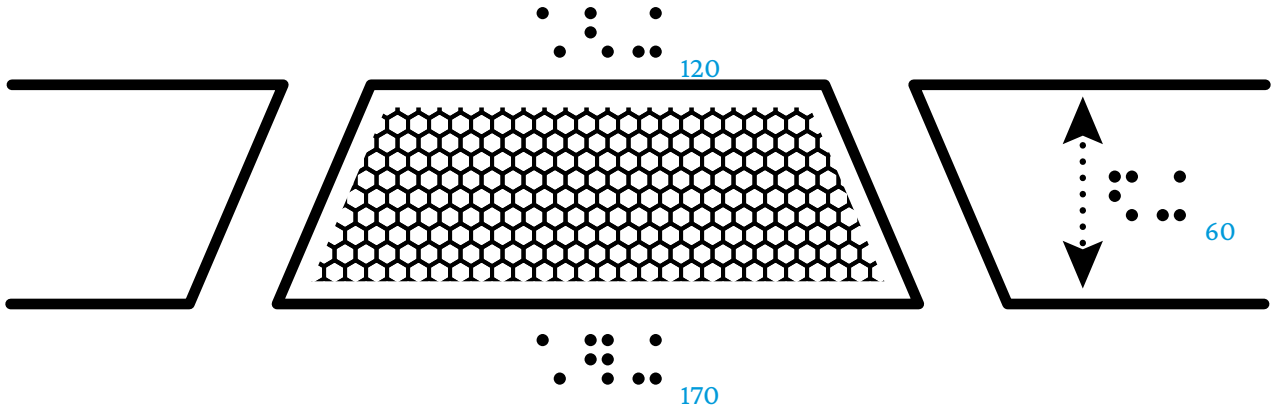

543

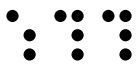
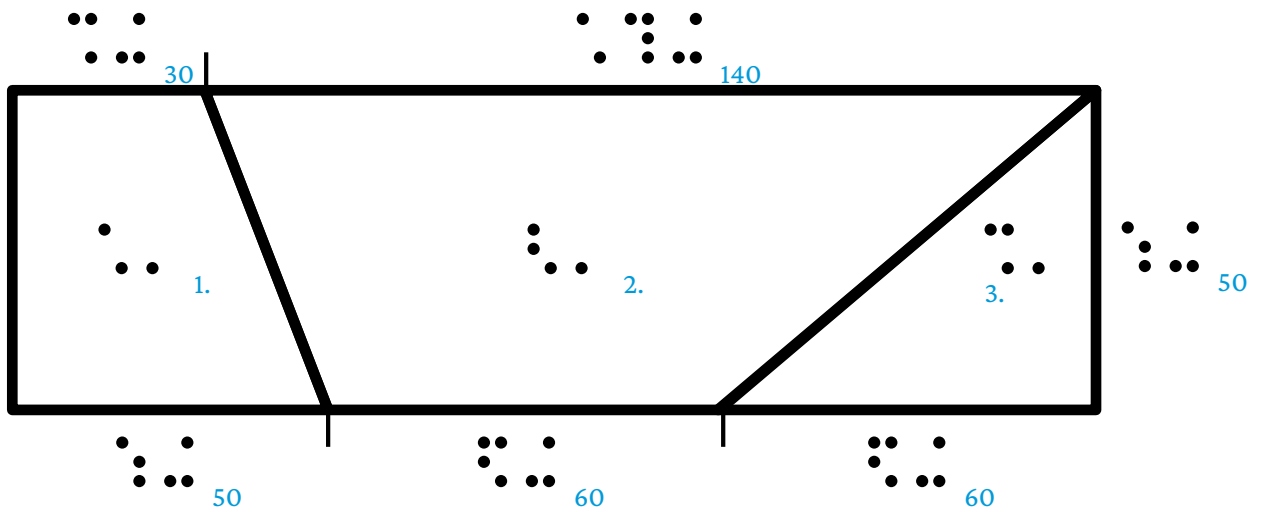

544

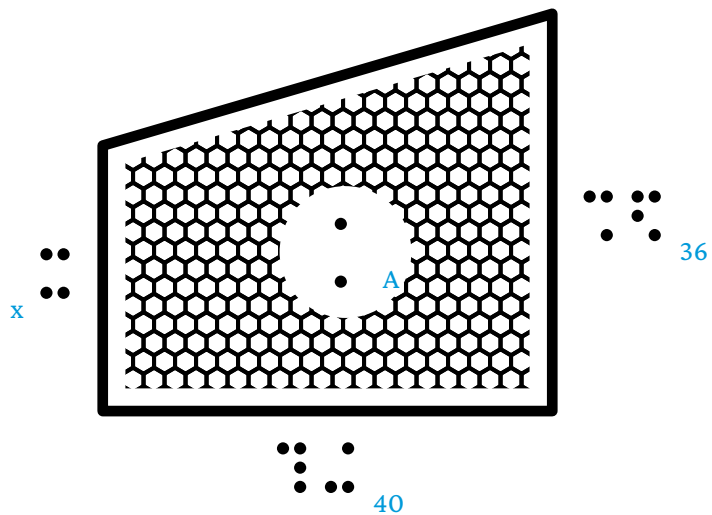

MVÜA3

S.93 546

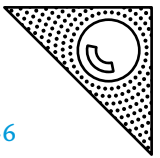

a)

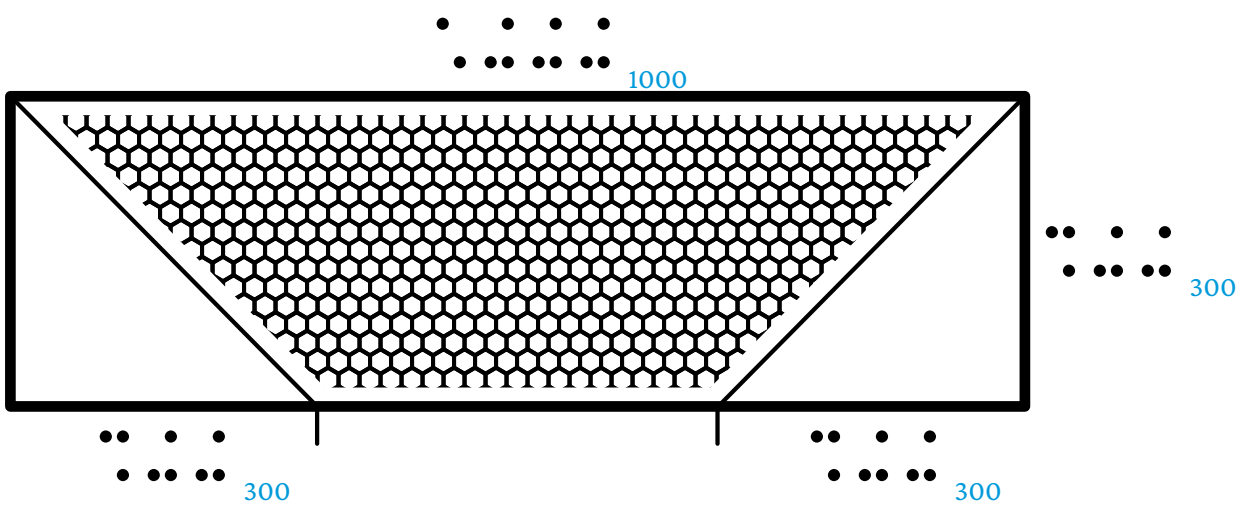

b)

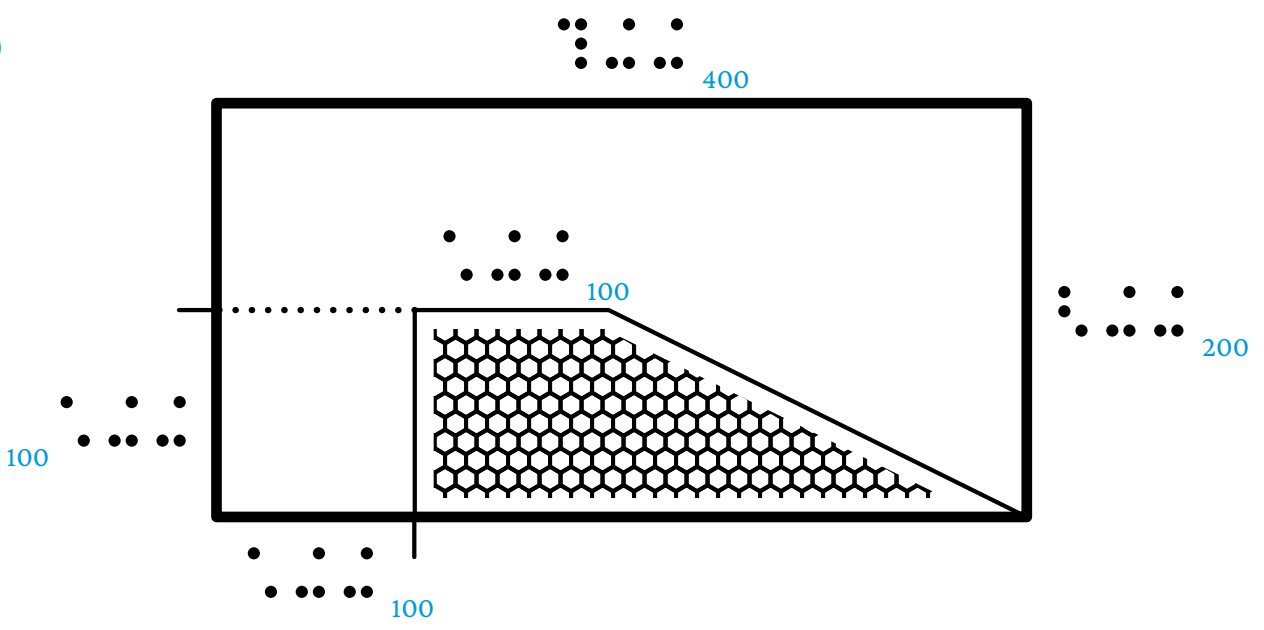

c)

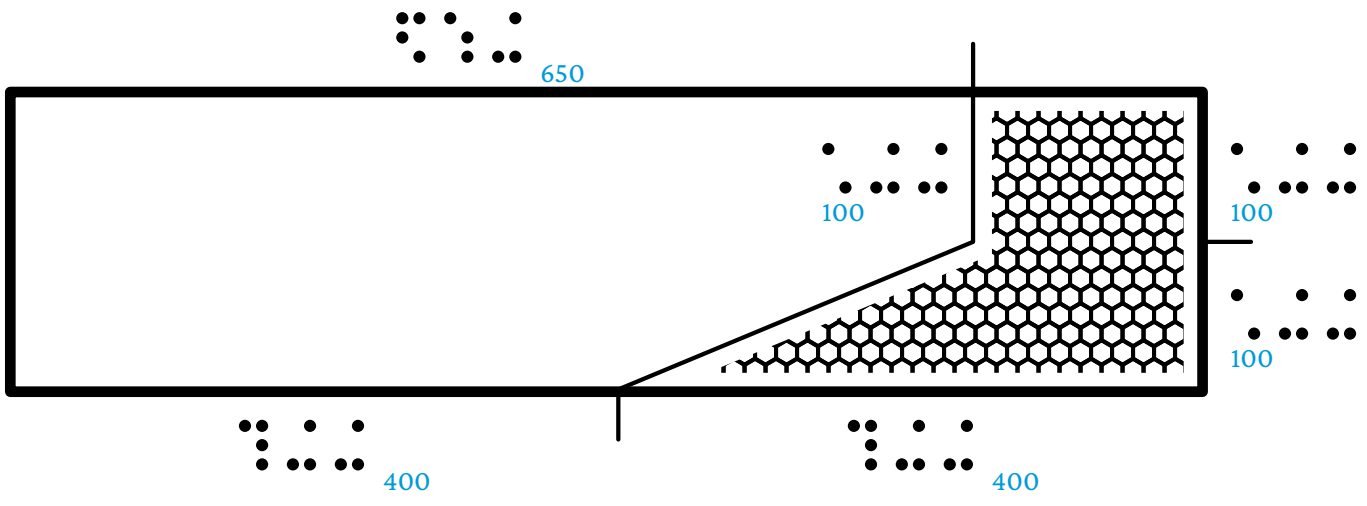

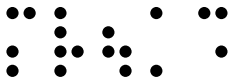

MVÜA3

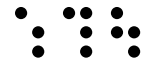
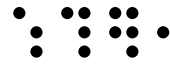

S.93 547, 548

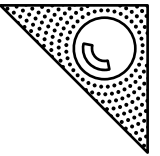

547

b

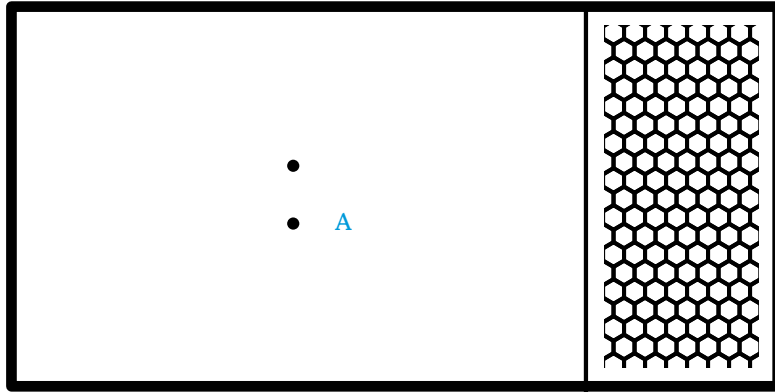

a



c



548

y

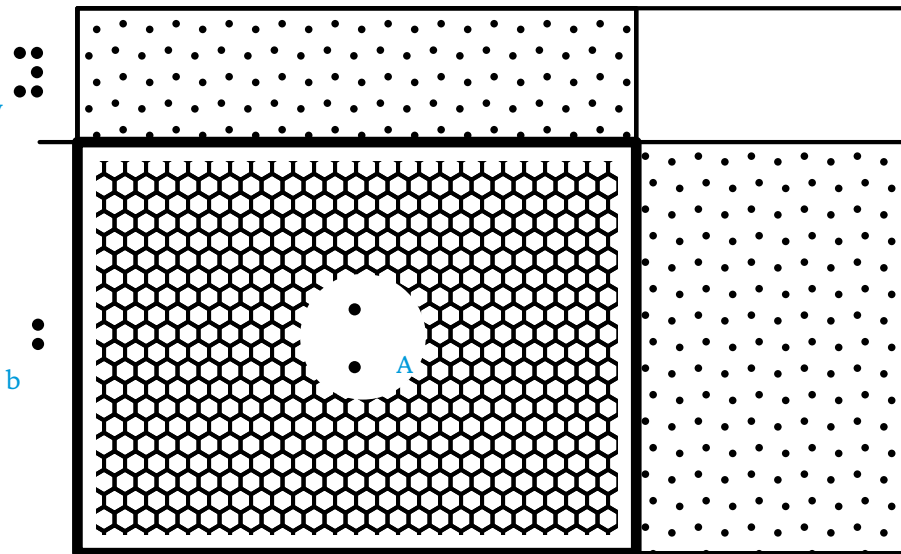

b



a



x