



Bundes-
Blindeninstitut
Wien

LeMa
Lehr- und Lernmaterialien

Vergrößerte und aufbereitete Versionen
ausgewählter Grafiken aus dem Schulbuch

Angewandte Mathematik HAK 2



Grafiken: Tomáš Batha

LEMA - Lehr- und Lernmaterialien
Hergestellt von der Abteilung für Inklusion und Lehrmittel am Bundes-Blindeninstitut Wien,
Wittelsbachstraße 5, 1020 Wien, Tel.: 01/728 08 66-405, 406, lmz@bbi.at, www.bbi.at

Angewandte Mathematik
HAK Band 2

2.

Matrizen

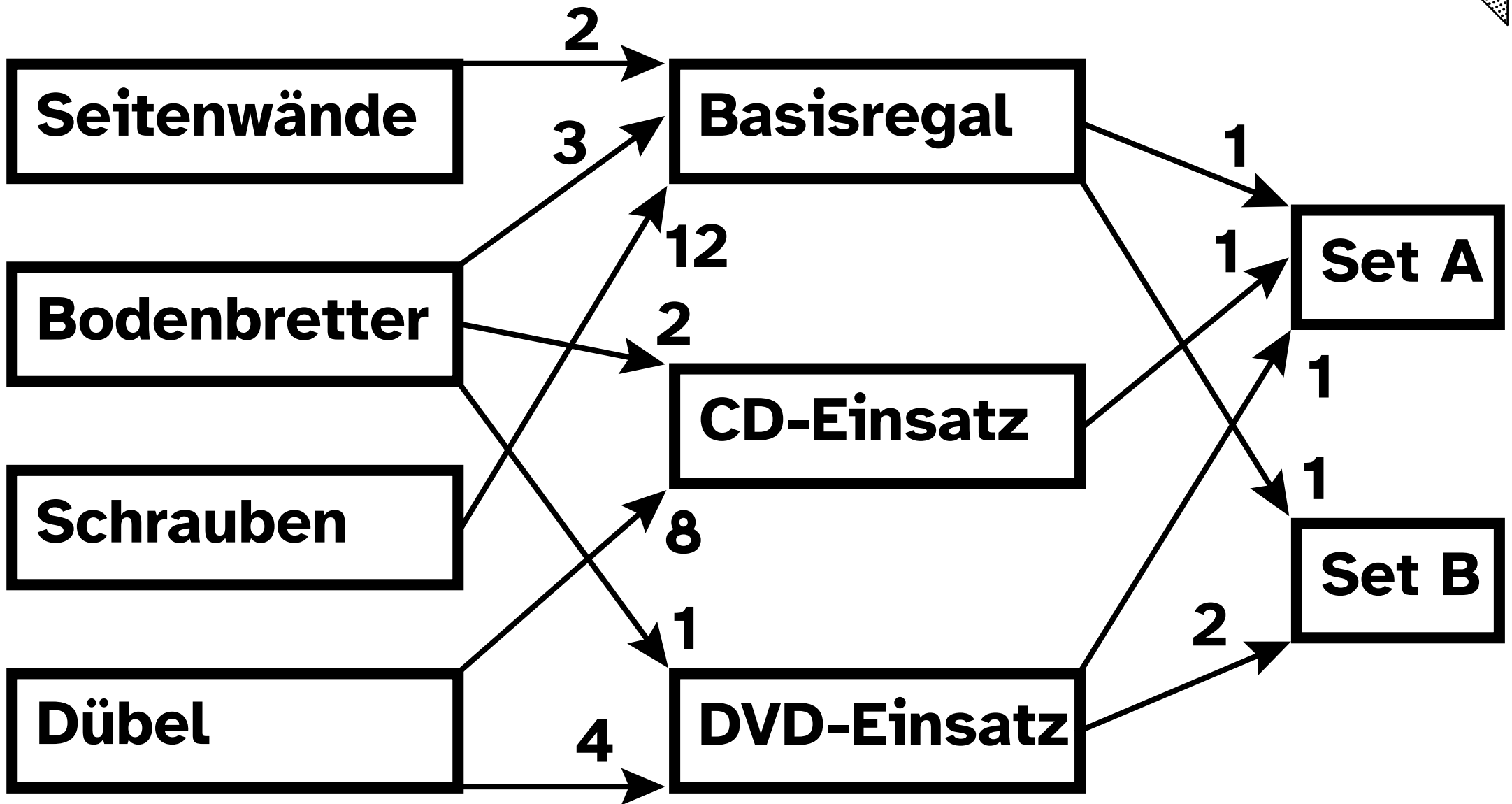
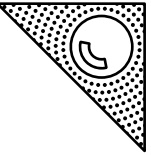

Bestandteile

Zwischenprodukte

Endprodukte

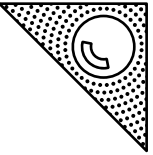

Schrank A

Schrank B

Regalboden

Hosenaufh.

Regalboden

Regalboden

Schublade

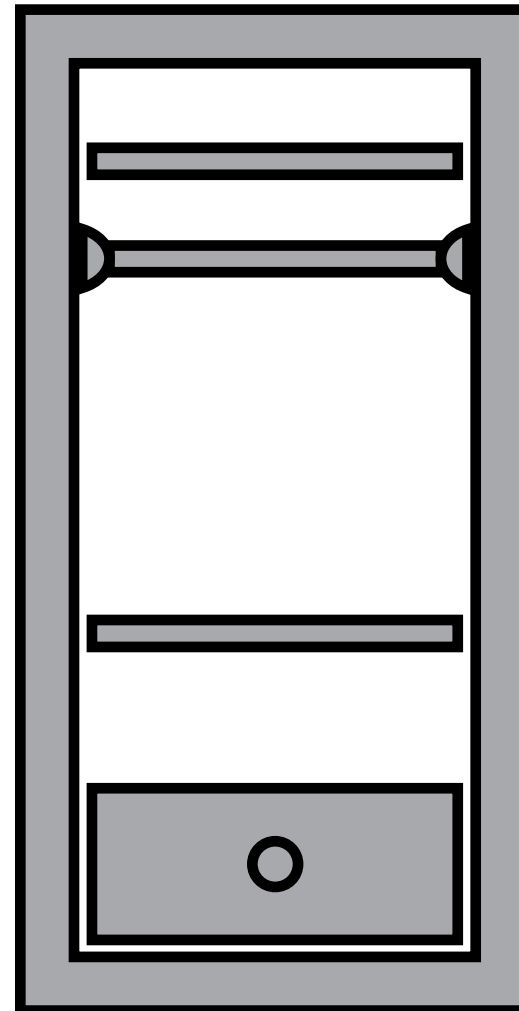
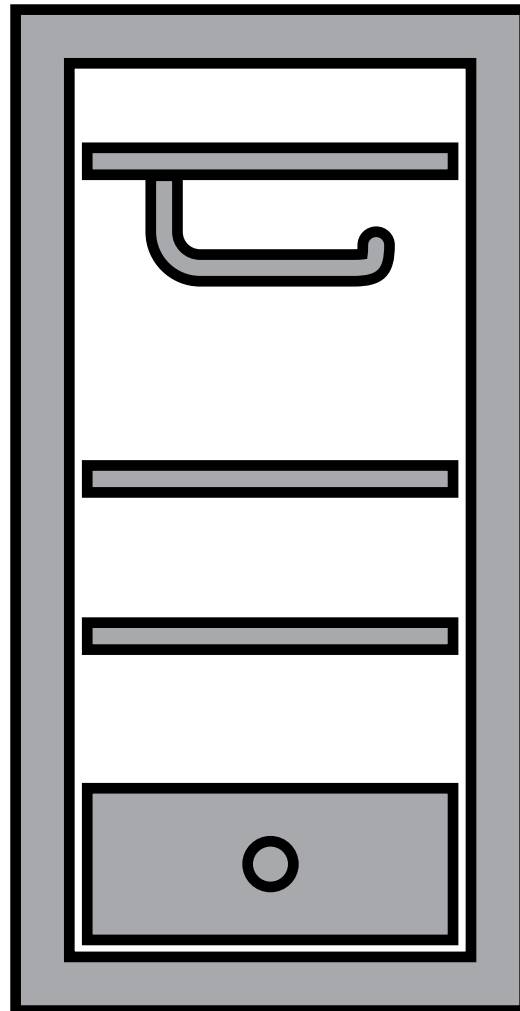

Regalboden

Kleiderst.

Regalboden

Schublade

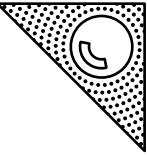

Regalboden

Schublade

**Hosen-
aufhängung**

**Kleider-
stange**

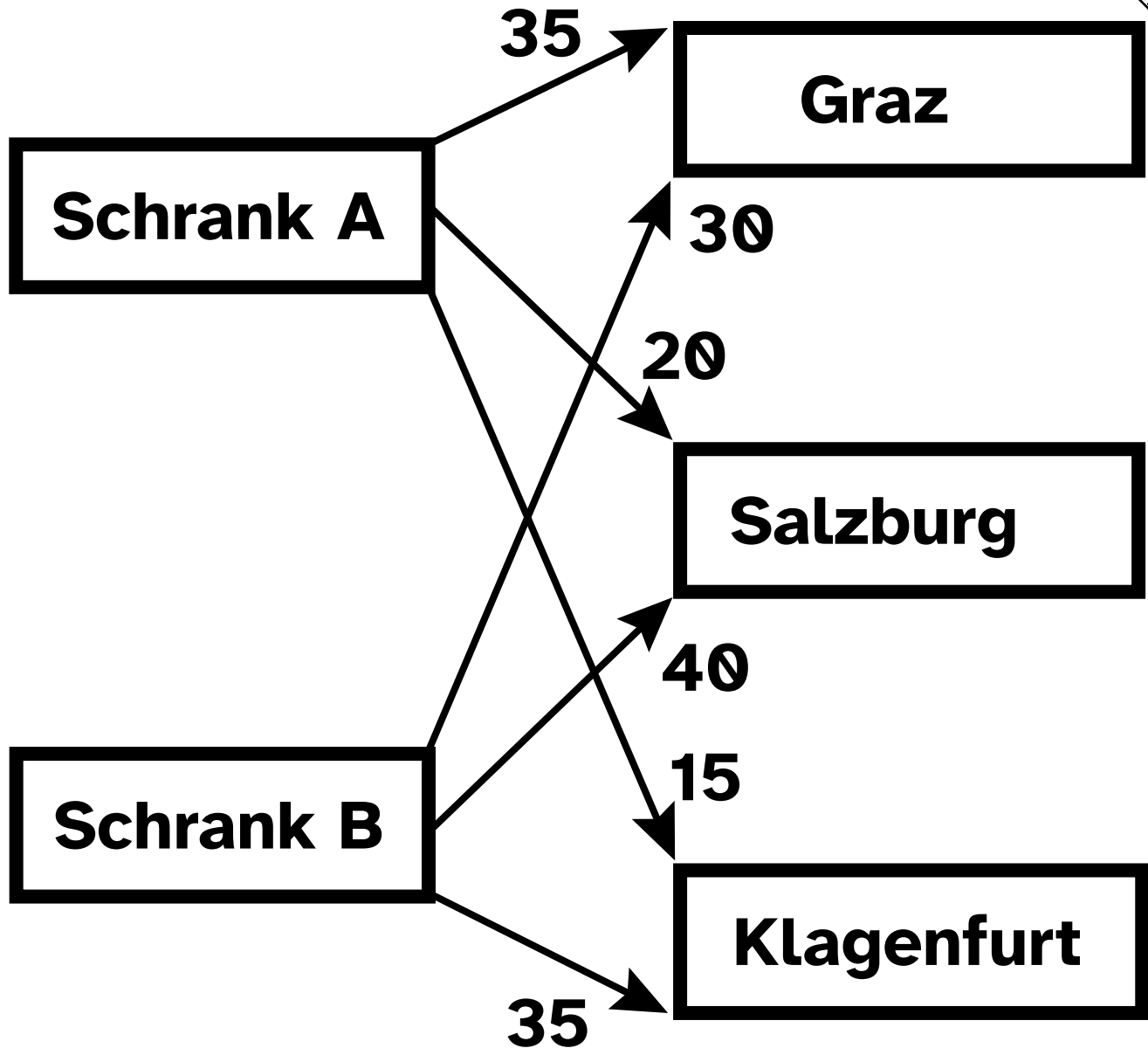

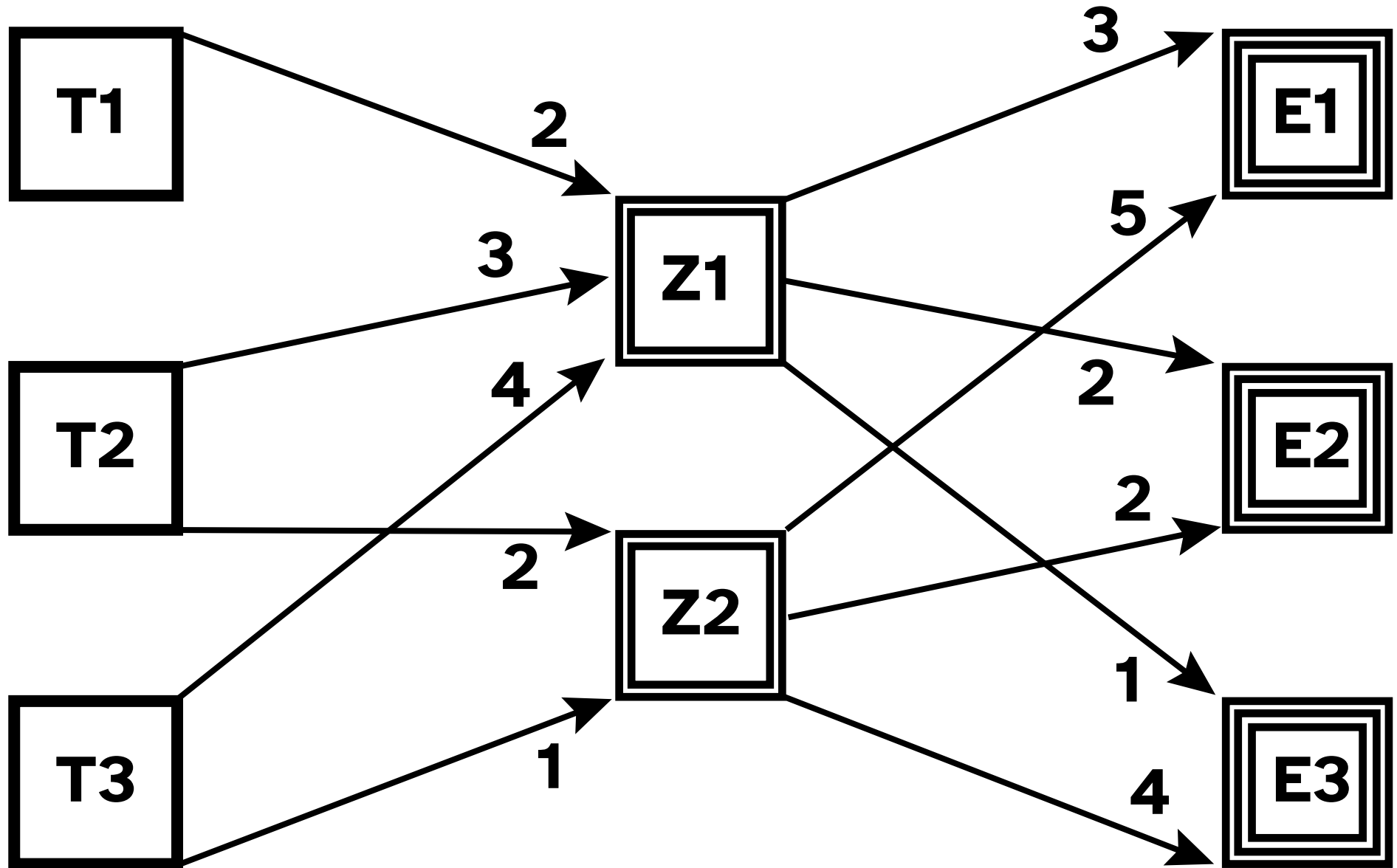
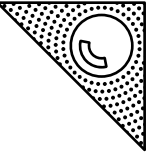

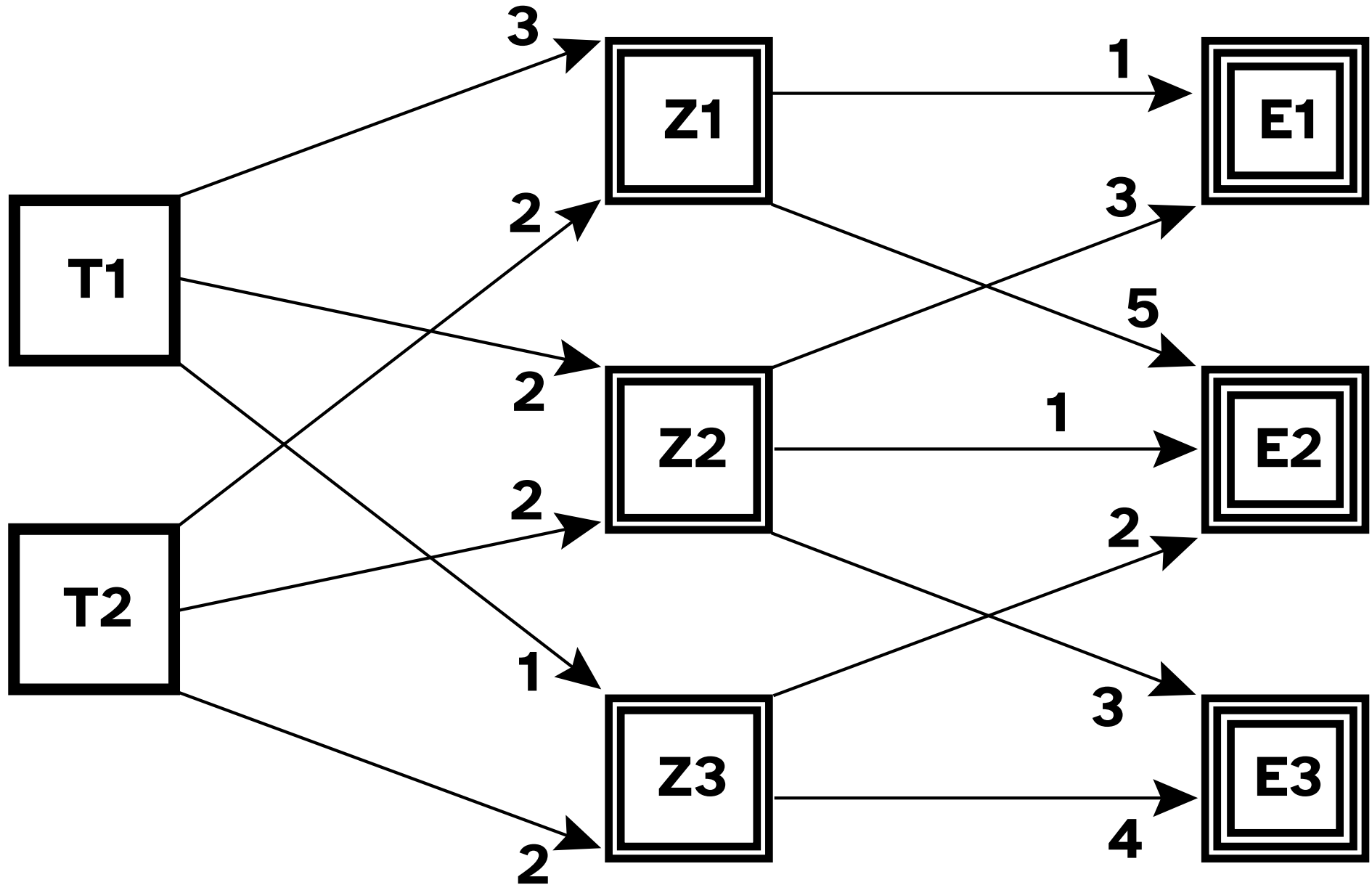
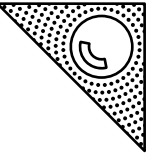

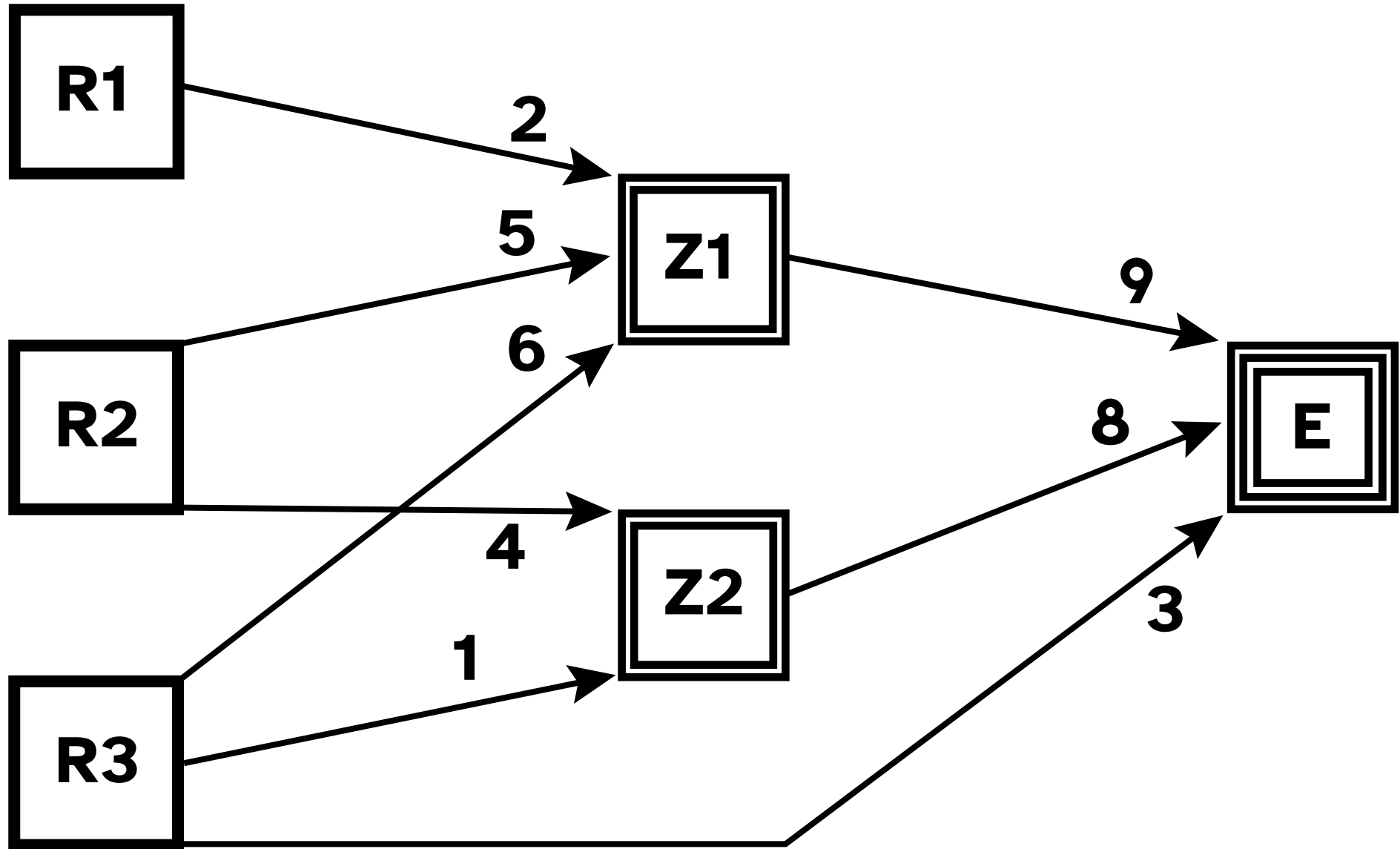
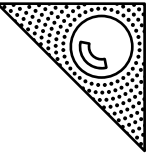

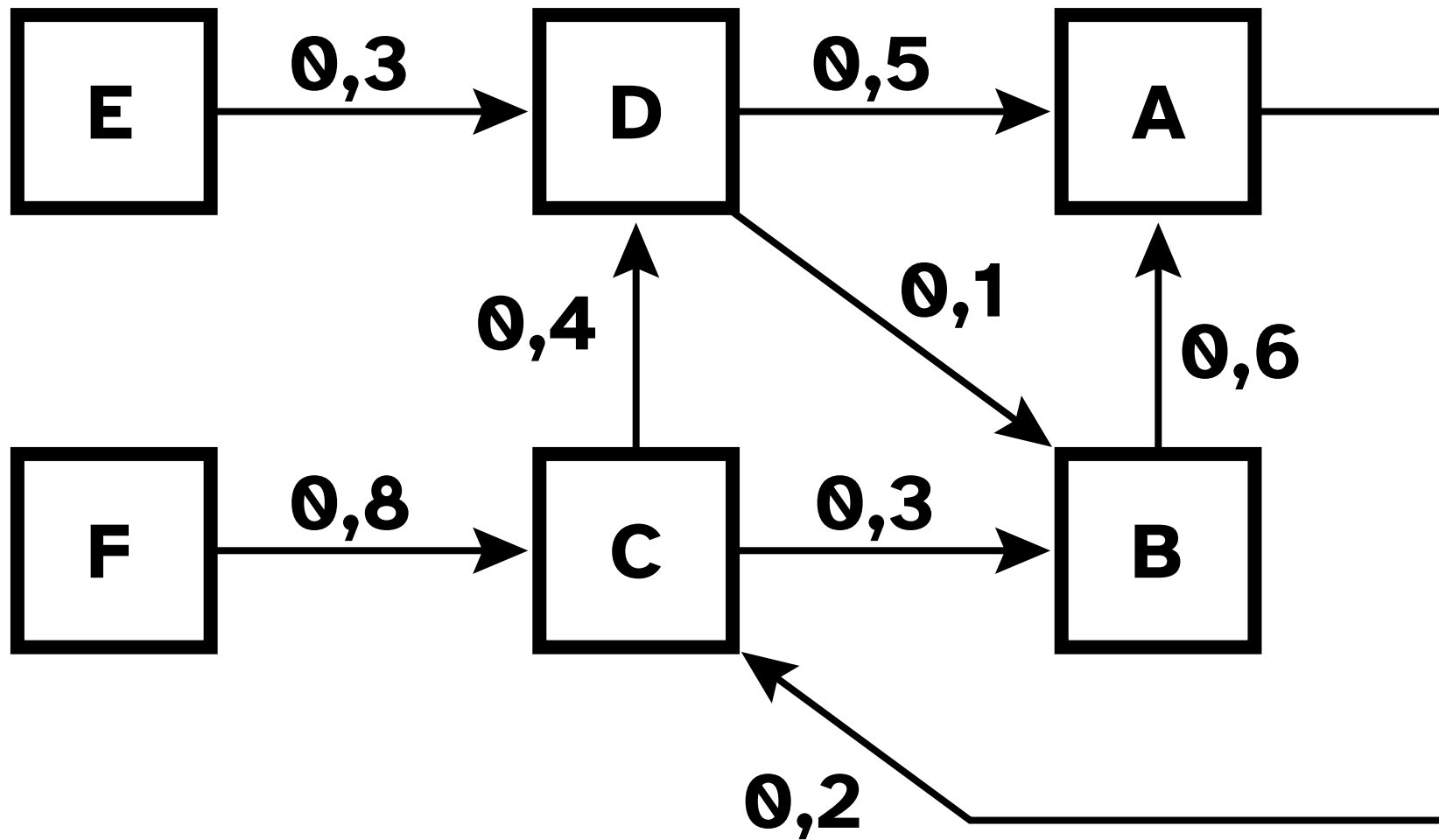
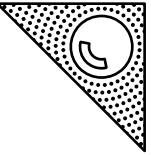

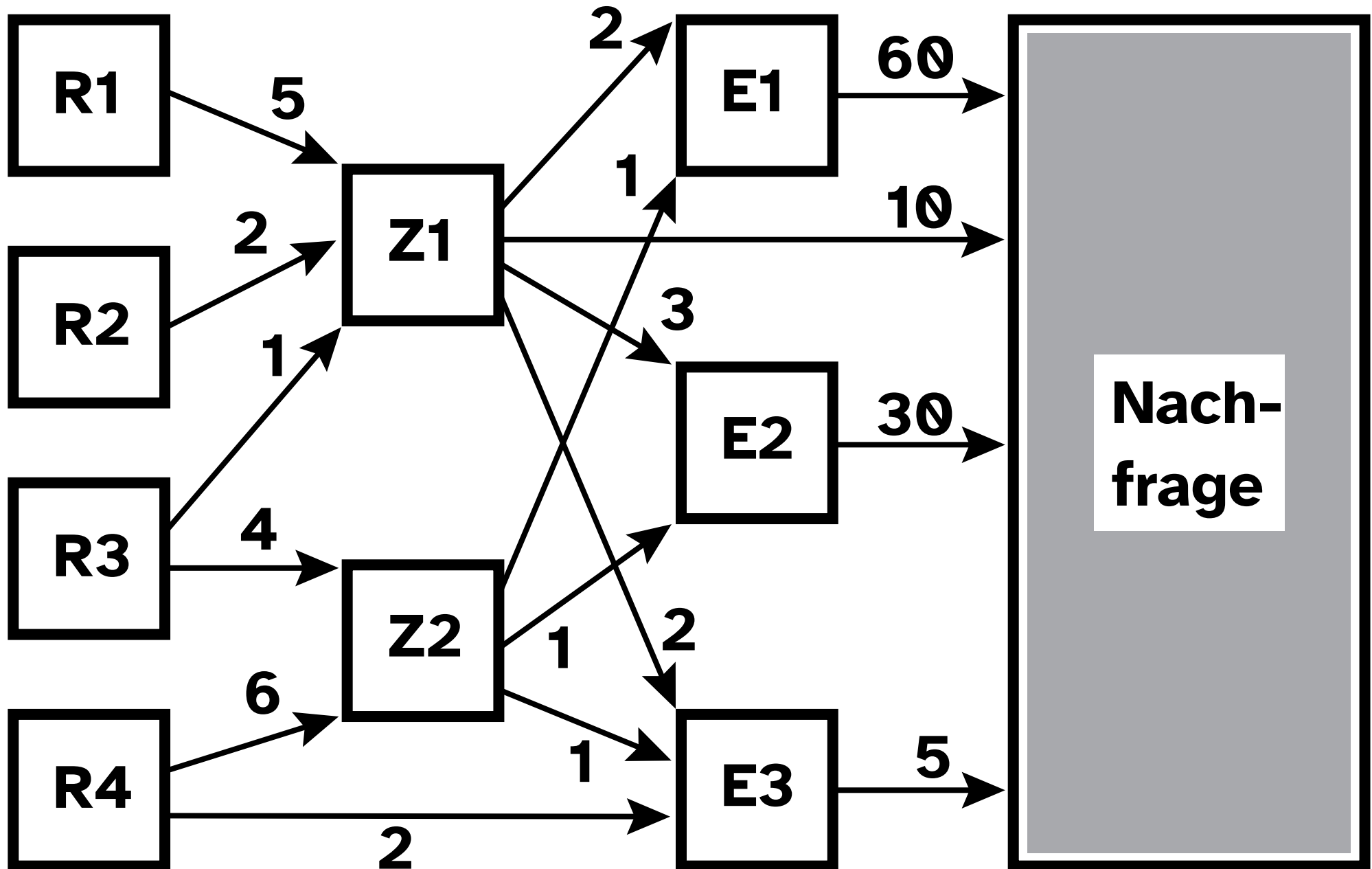
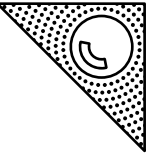

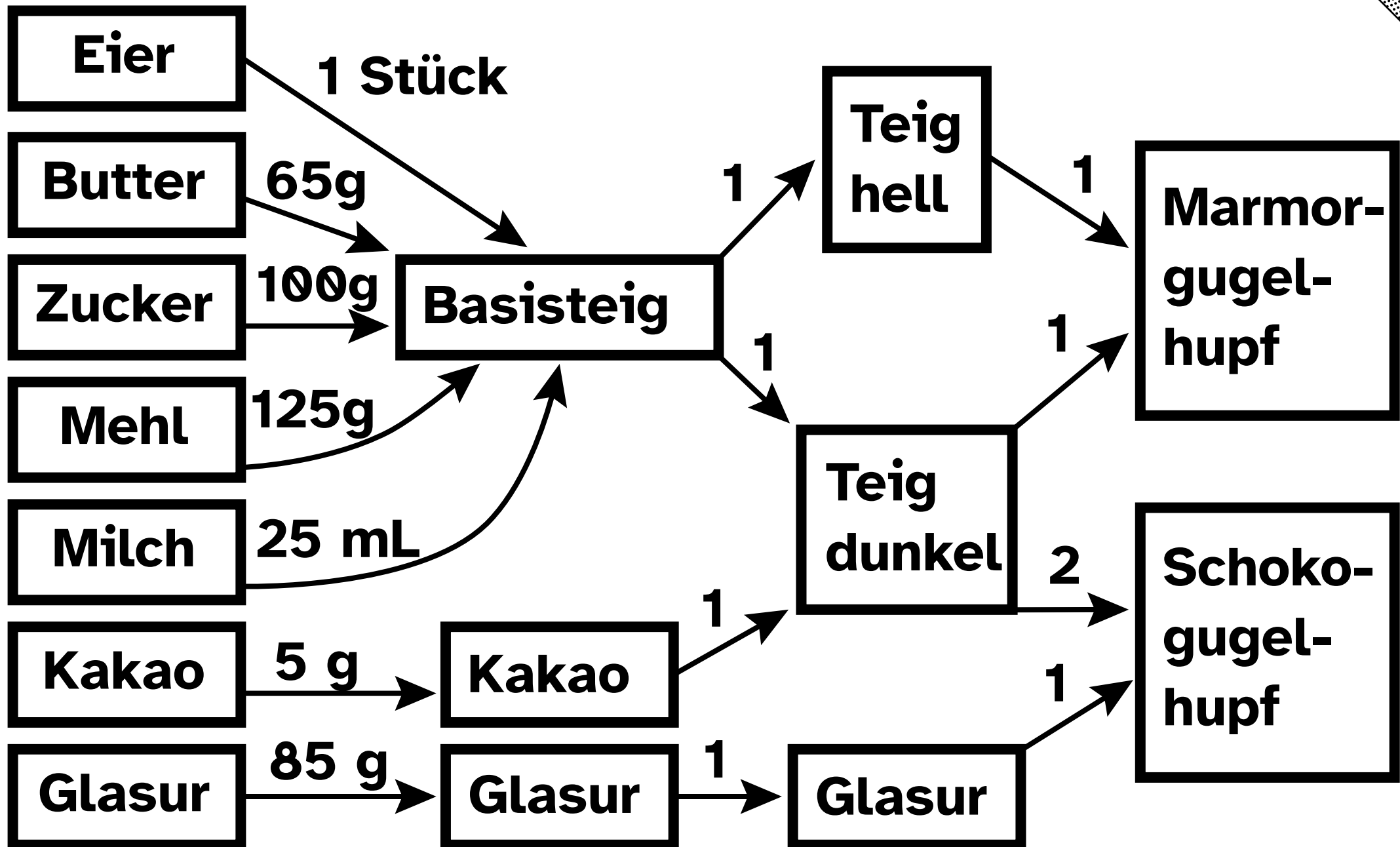
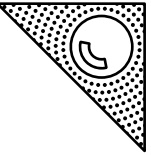

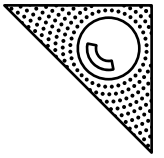

Angewandte Mathematik

HAK Band 2

5.

Trigonometrie

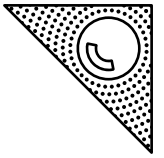

Angewandte Mathematik HAK Band 2

5. Trigonometrie

Teil 1, Seiten 106 - 119

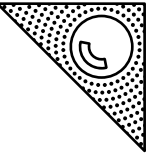

Winkel - Definition

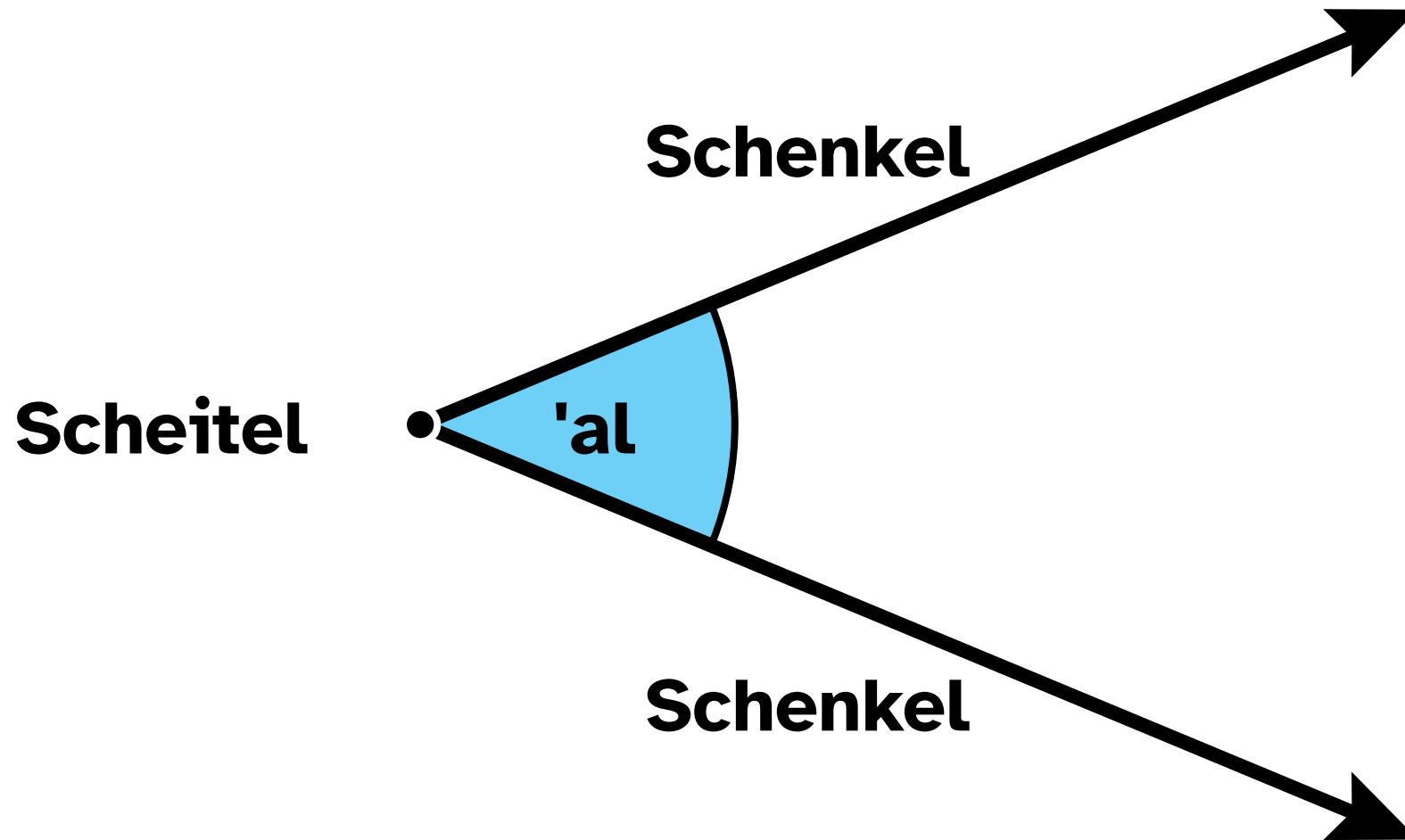

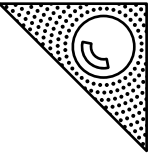

Einteilung der Winkel nach ihrer Größe 1/2

**spitzer
Winkel**

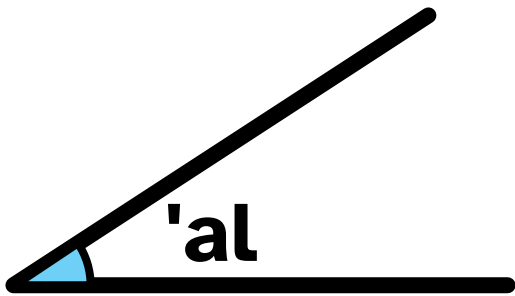

$$0^\circ < 'a < 90^\circ$$

**rechter
Winkel**

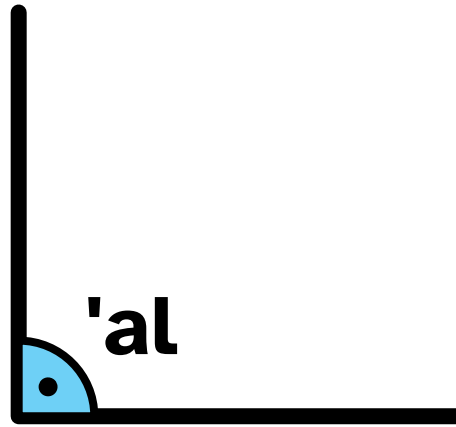

$$'a = 90^\circ$$

**stumpfer
Winkel**

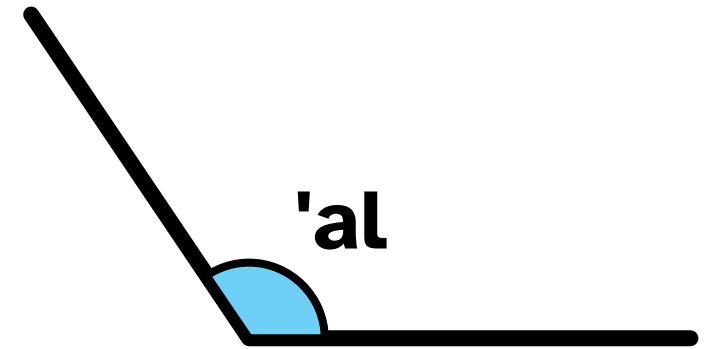

$$90^\circ < 'a < 180^\circ$$

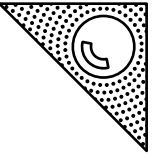

Einteilung der Winkel nach ihrer Größe 2/2

**gestreckter
Winkel**

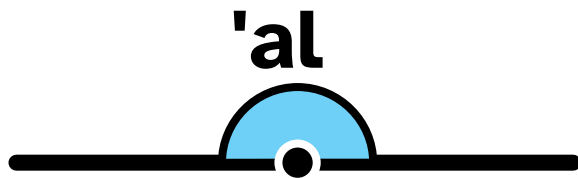

$$'al = 180^\circ$$

**erhabener
Winkel**

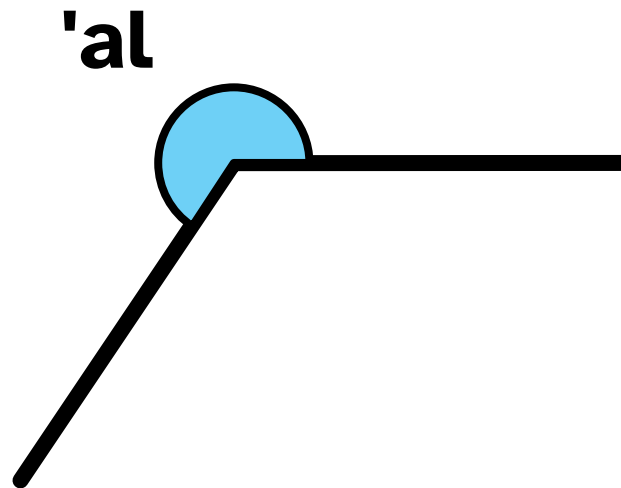

$$180^\circ < 'al < 360^\circ$$

**voller
Winkel**

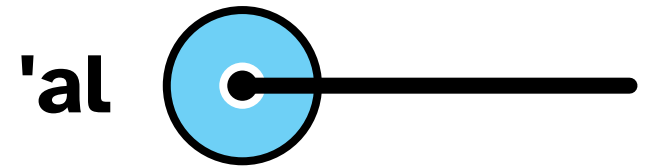

$$'al = 360^\circ$$

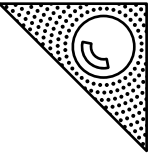

Winkelpaare in besonderer Lage

Komplementärwinkel

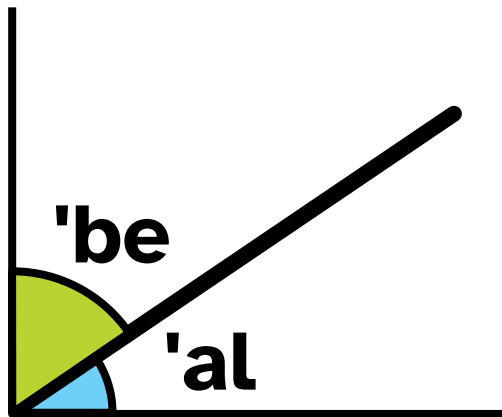

$$'al + 'be = 90^\circ$$

ergänzen einander auf 90°

Supplementärwinkel

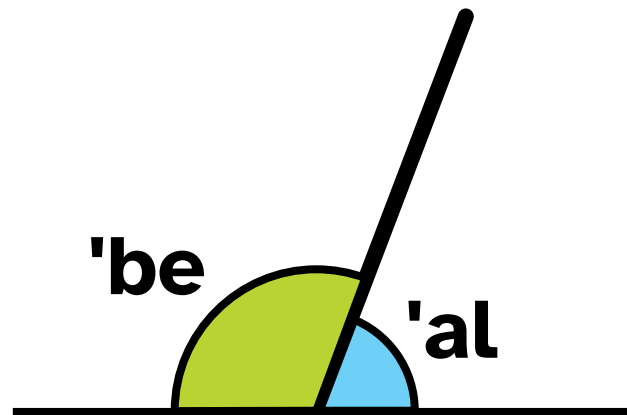

$$'al + 'be = 180^\circ$$

ergänzen einander auf 180°

Wechselwinkel

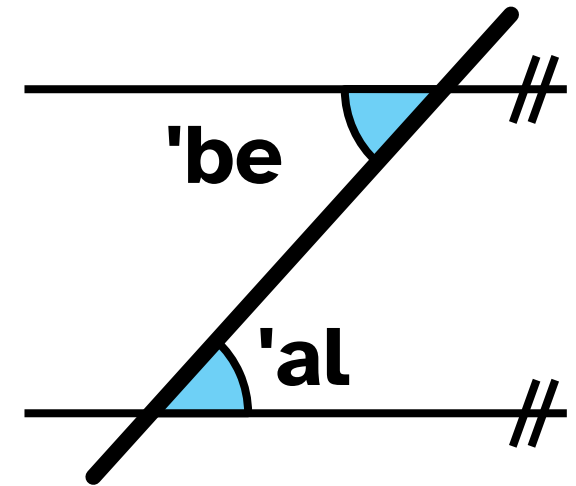

$$'al = 'be$$

entspr.

Winkel sind gleich groß

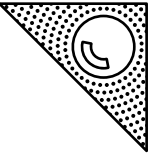

Normalwinkel

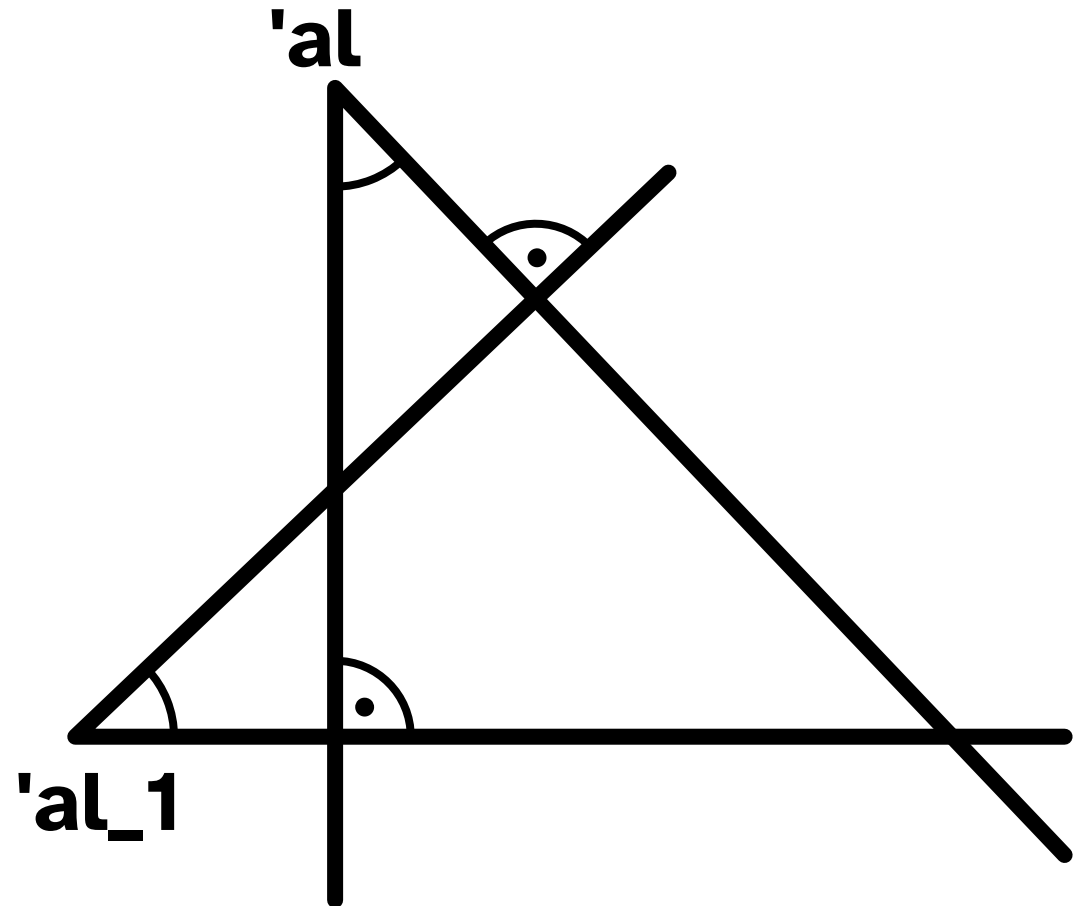
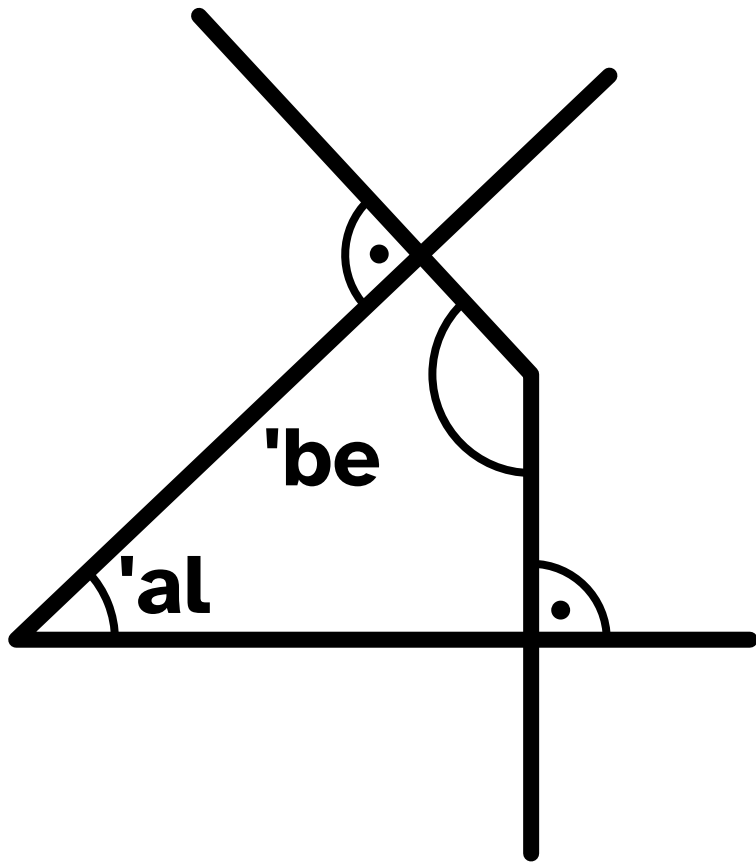

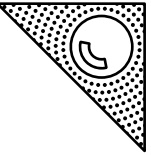

Normalwinkel
Beispiel

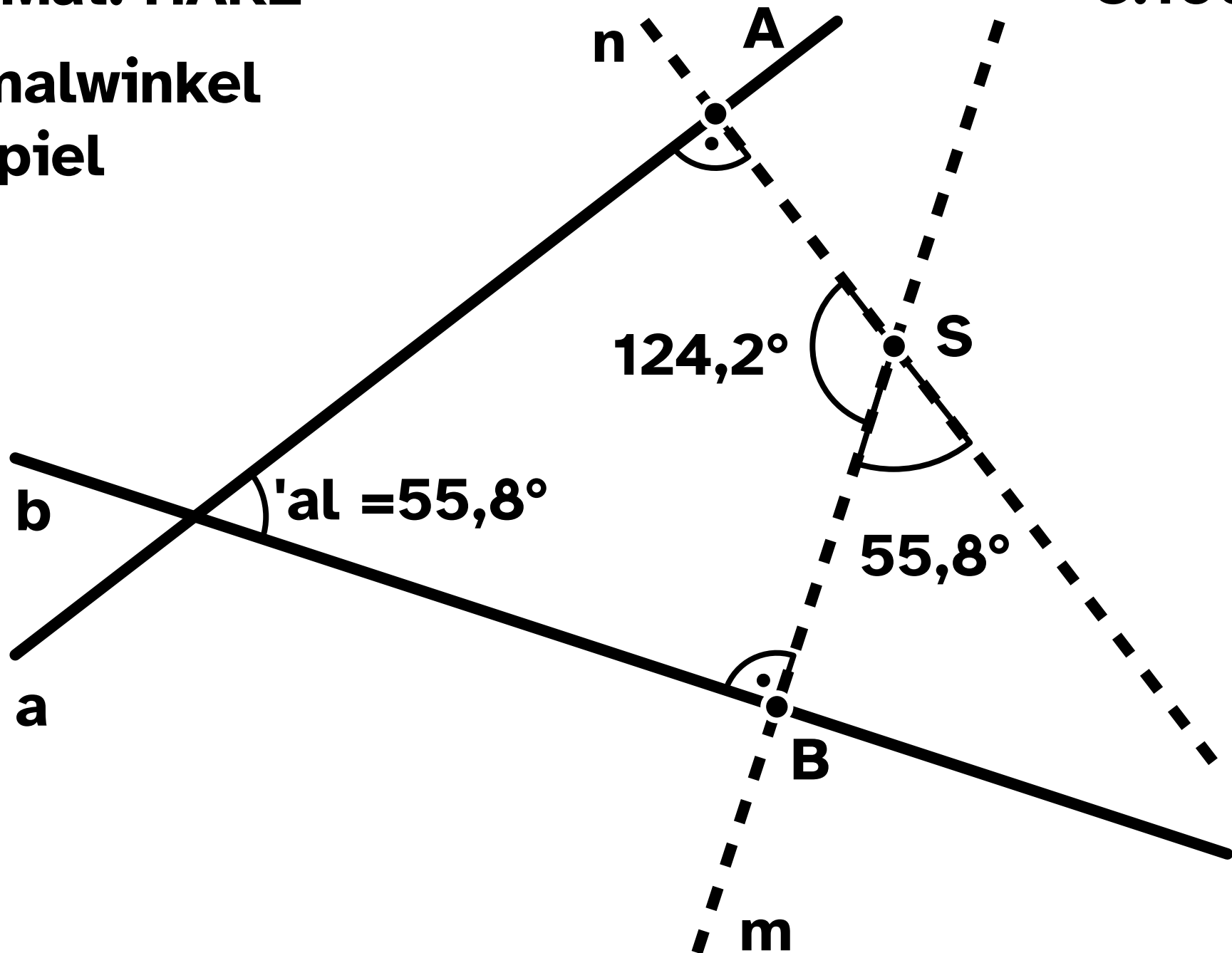

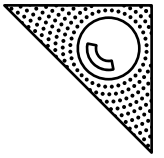

a)

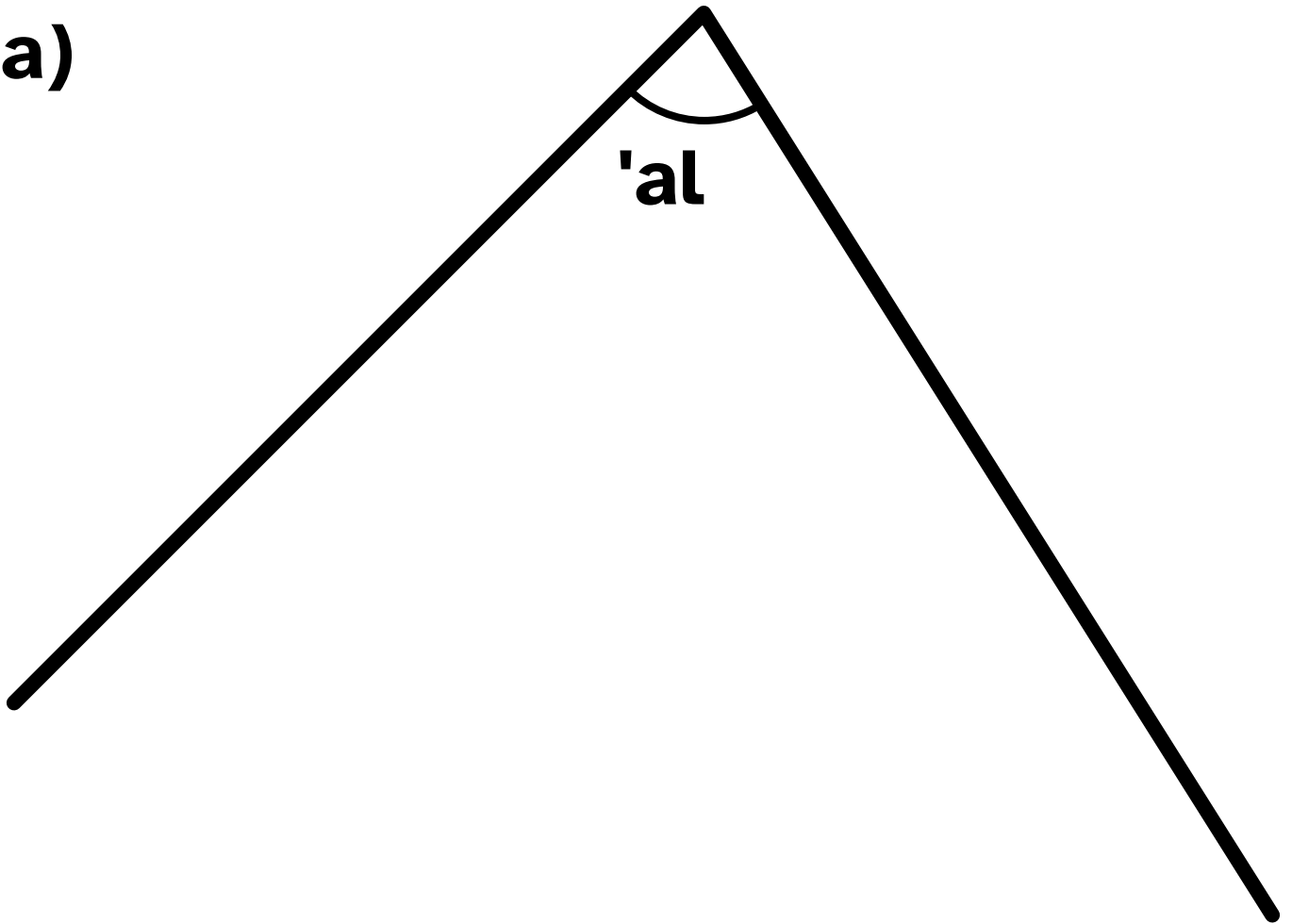

b)

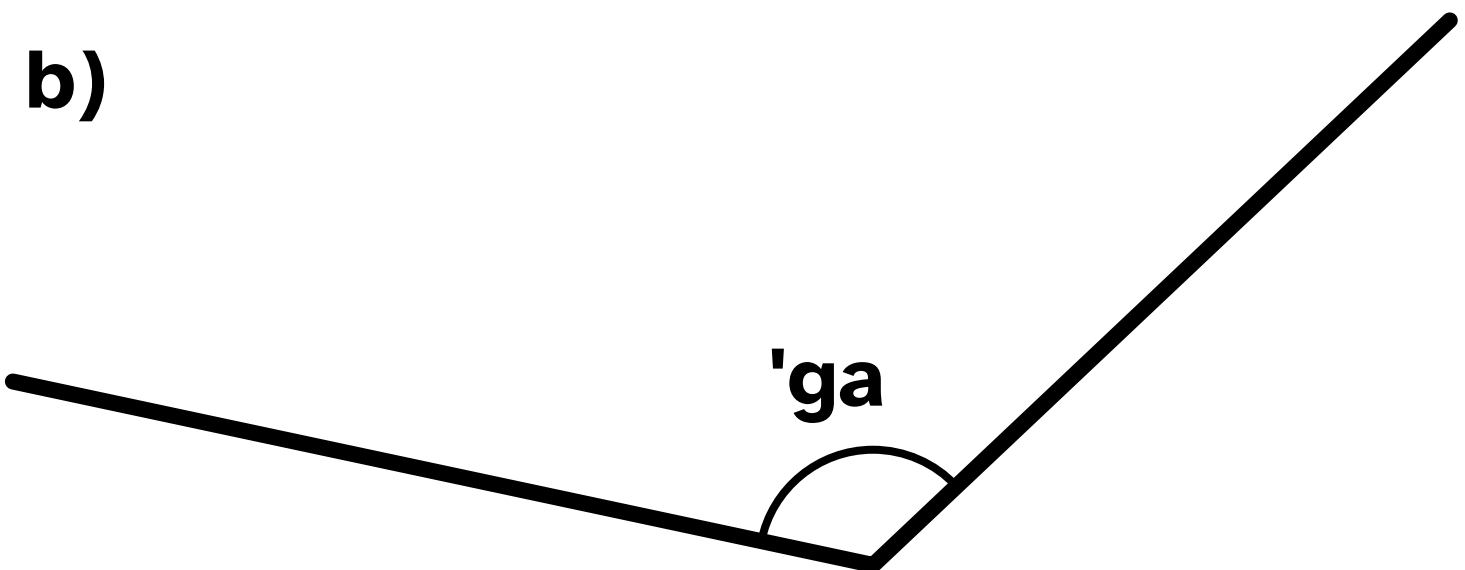

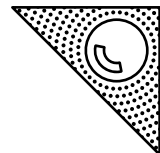

c)

'be

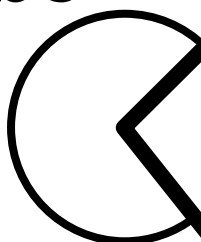

d)

'de

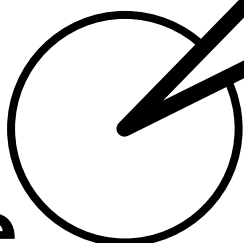

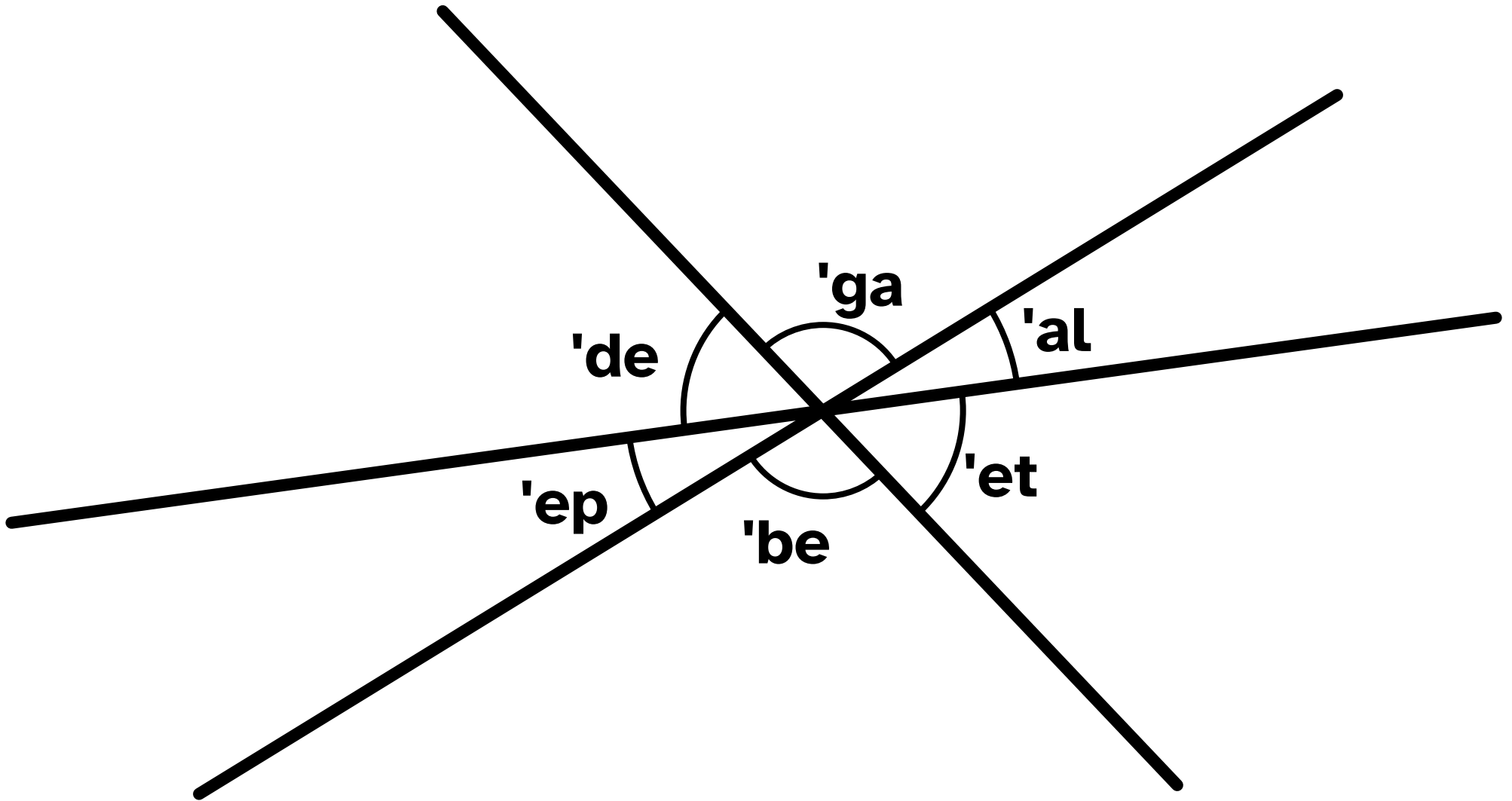
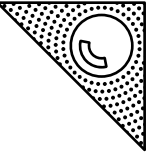

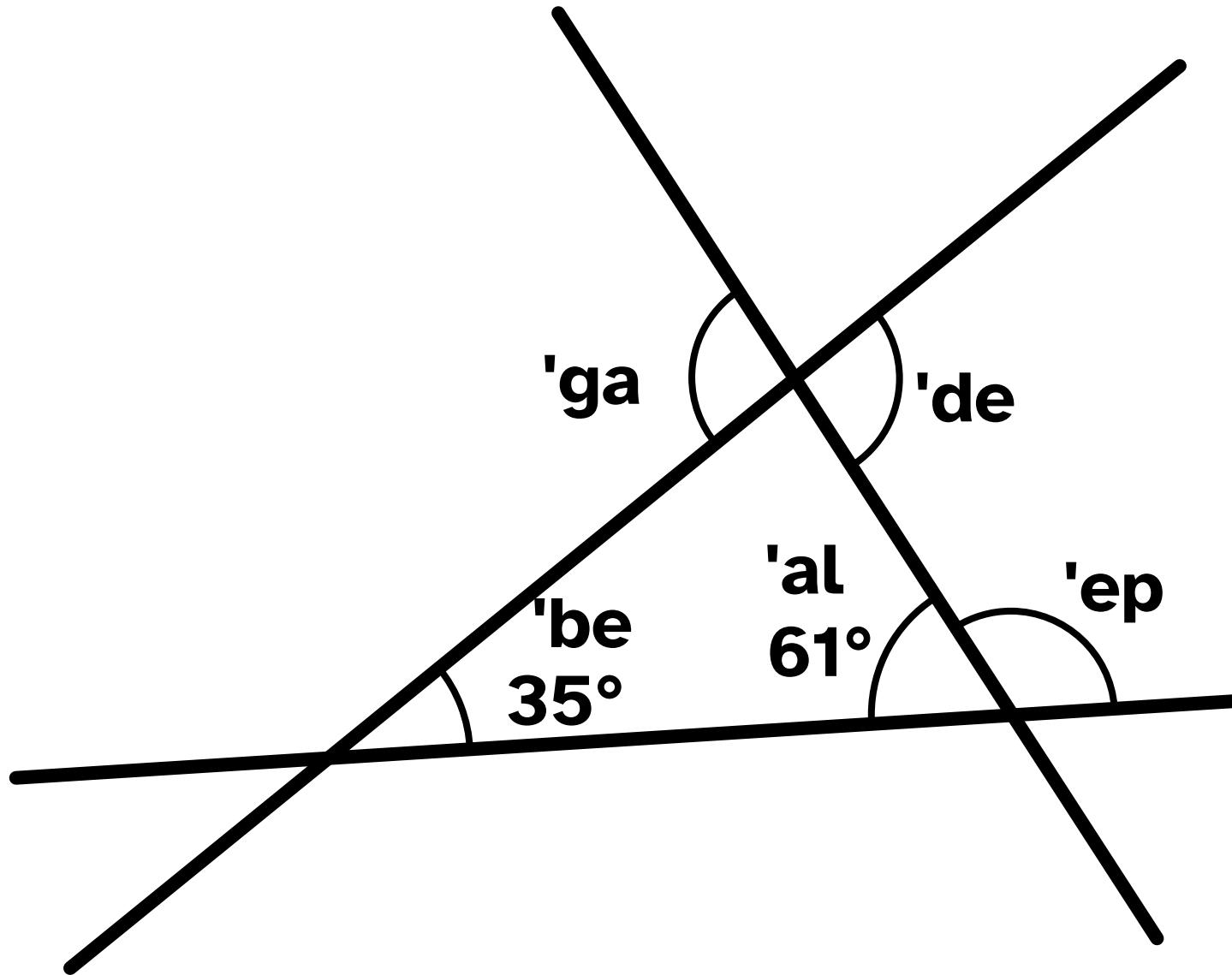
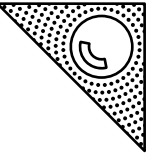

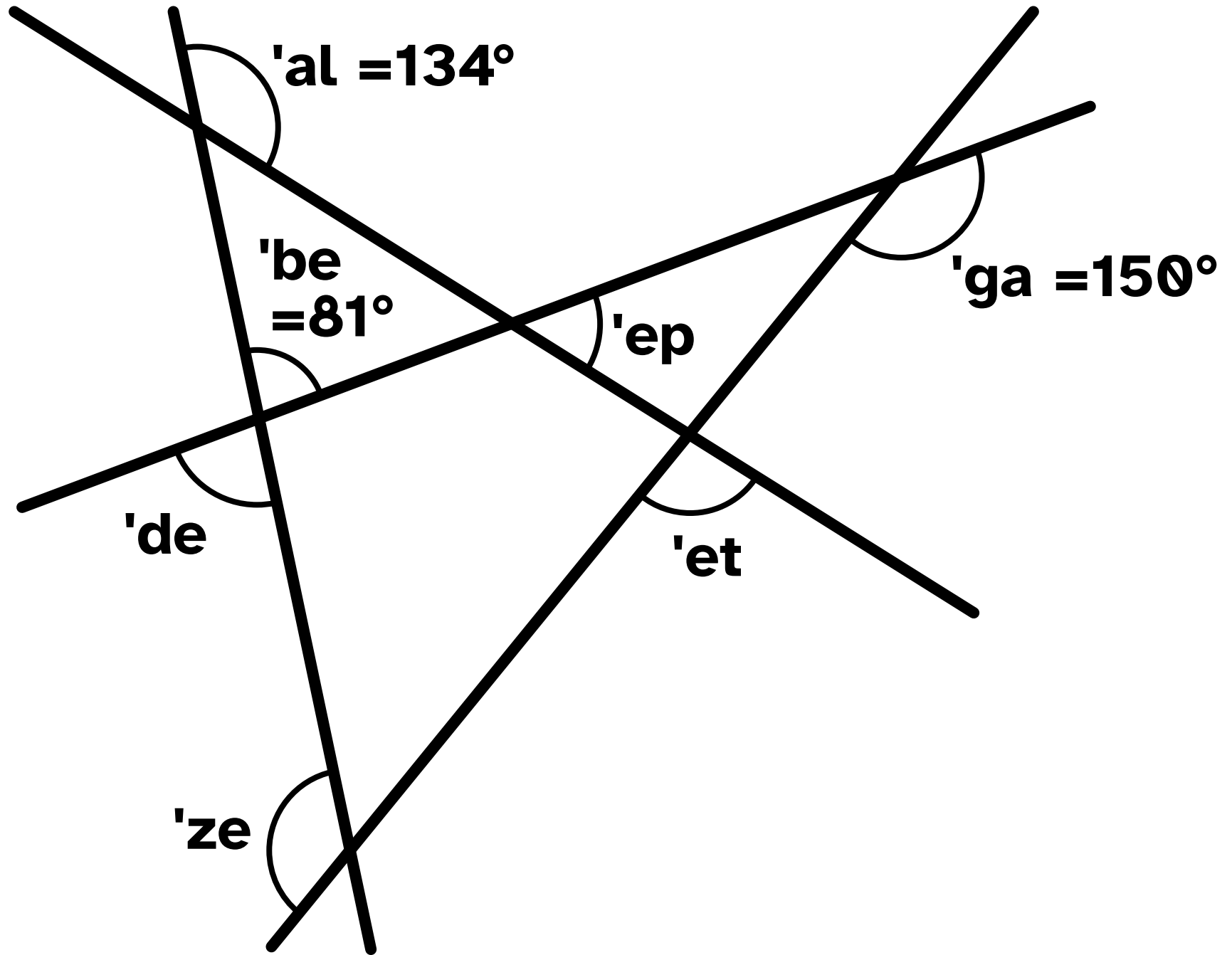
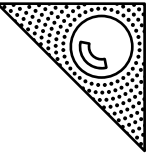

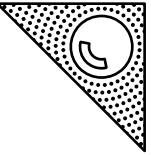

a)

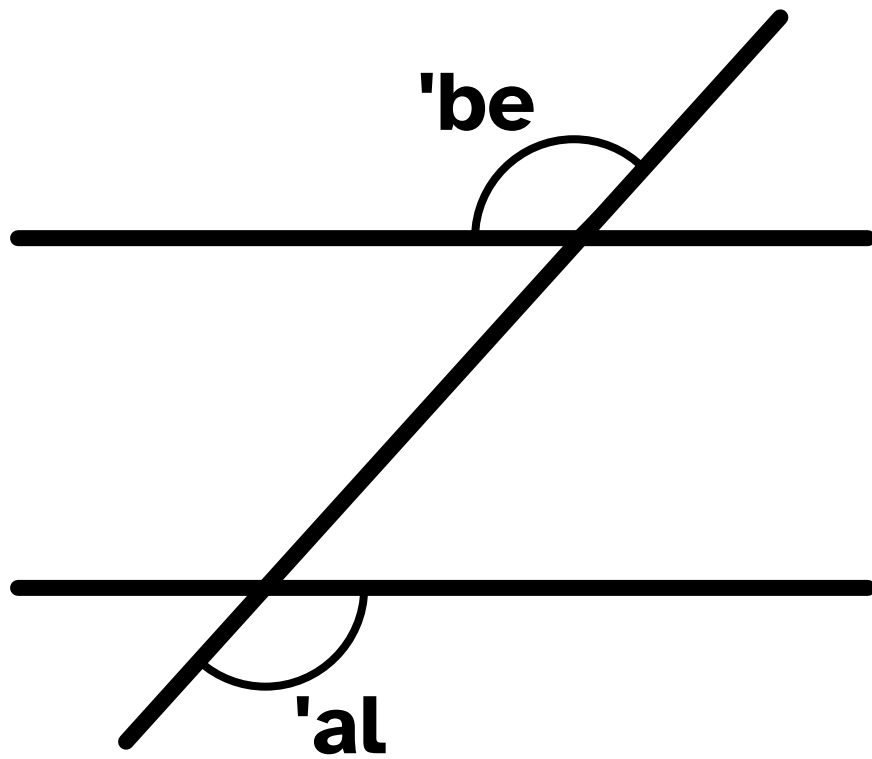

b)

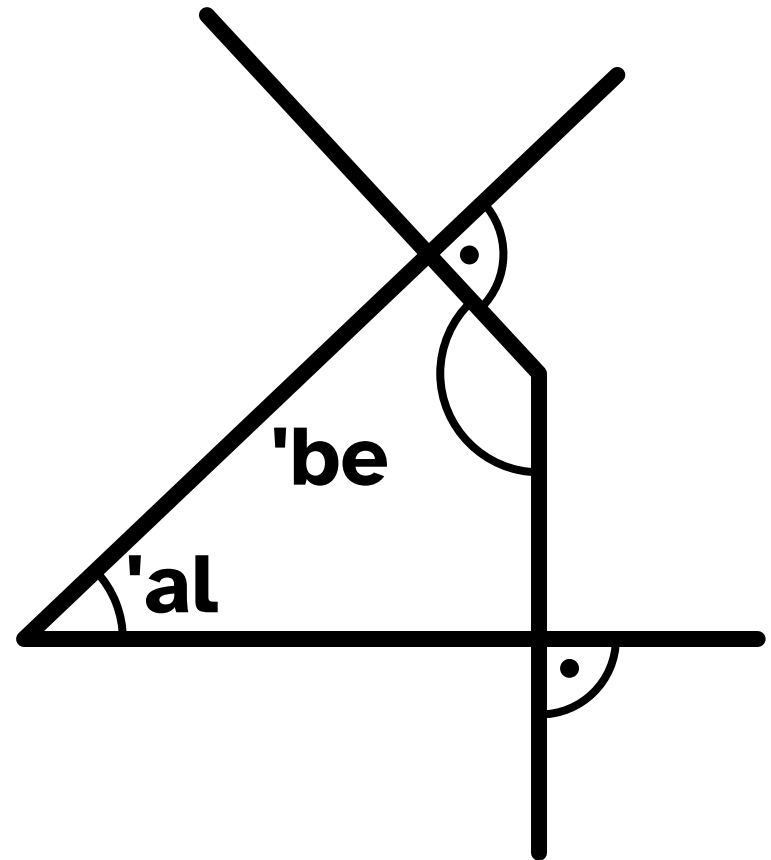

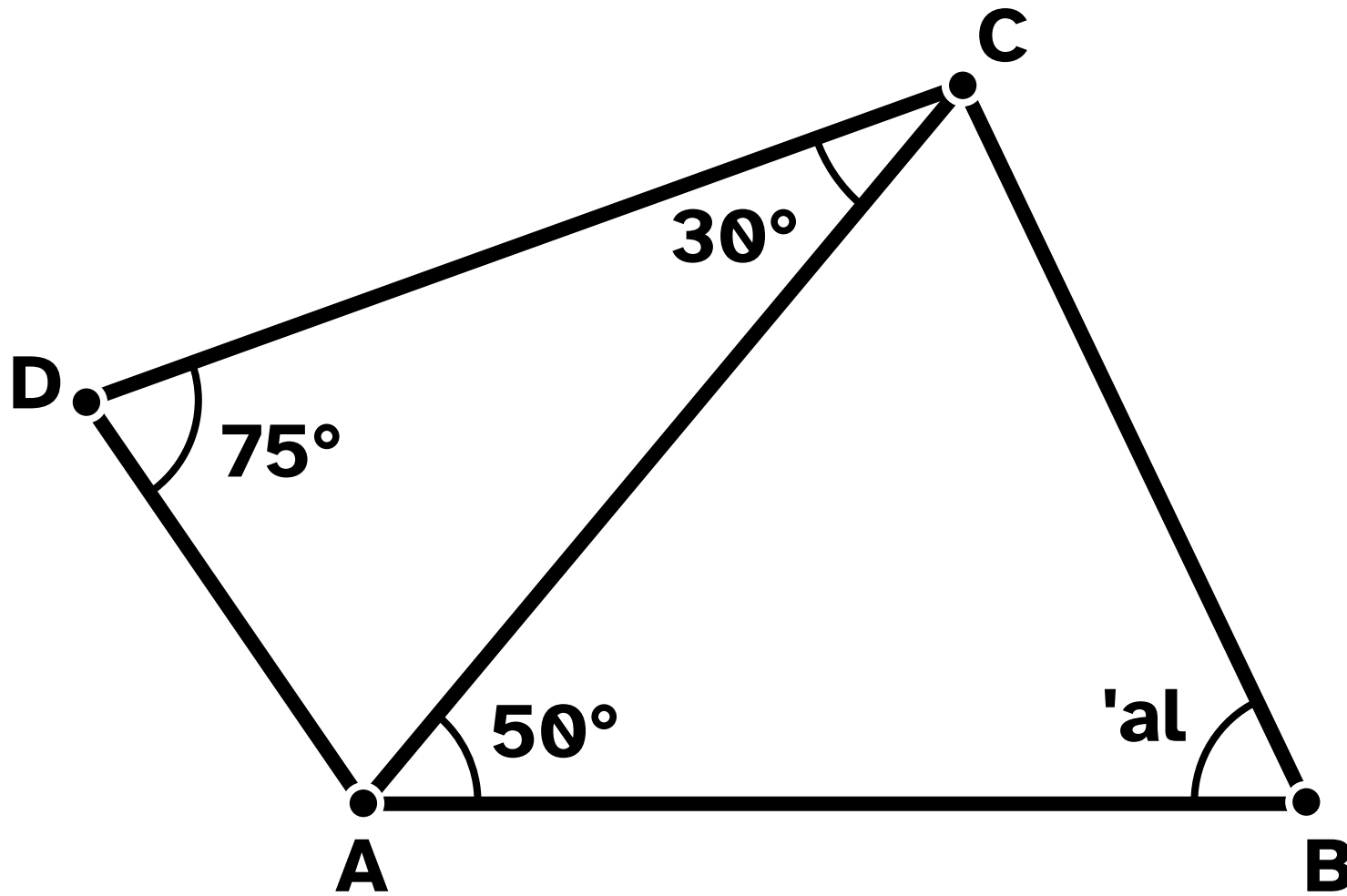
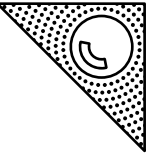

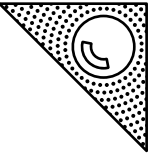

Einteilung der Dreiecke nach den Seiten

1) allgemeines Dreieck

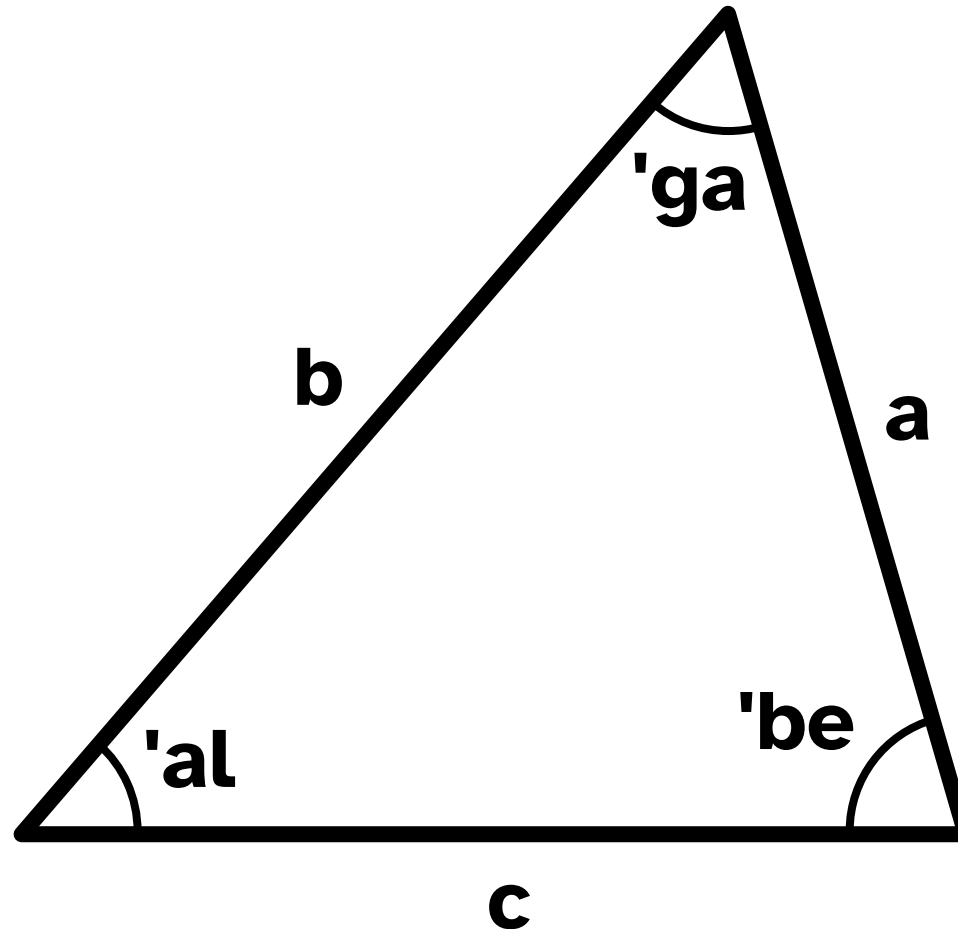

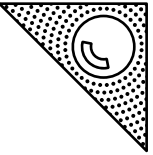

Einteilung der Dreiecke nach den Seiten

1) gleichschenkliges Dreieck

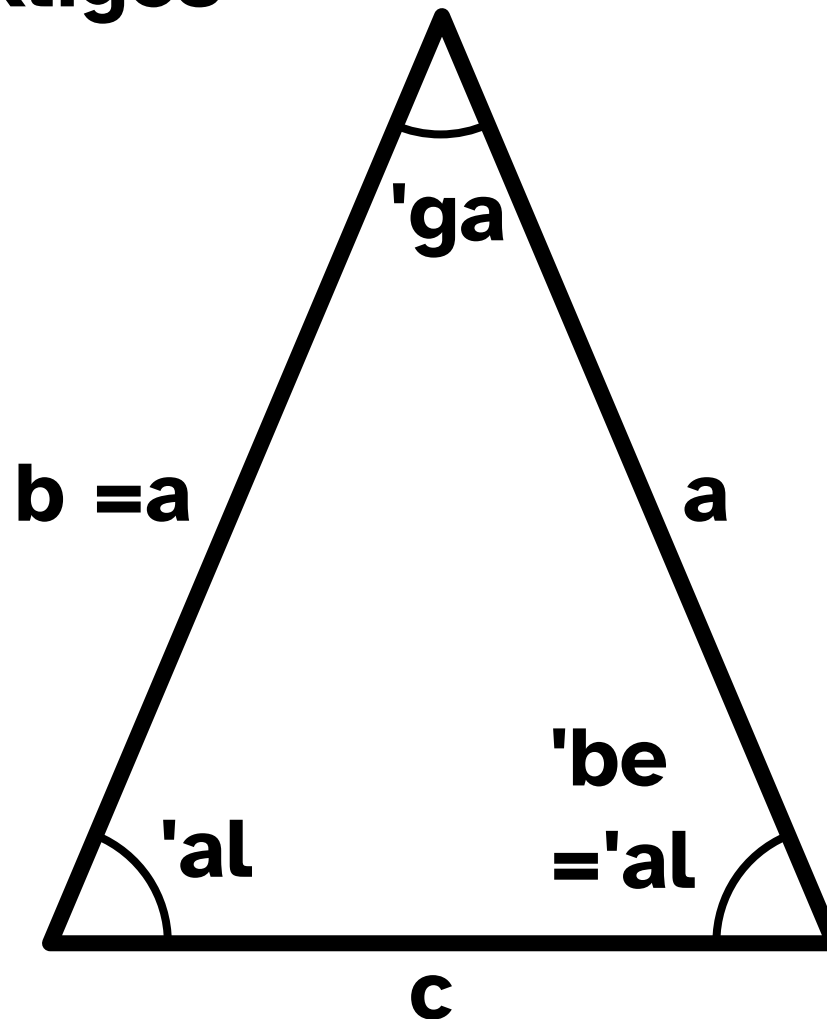

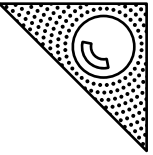

Einteilung der Dreiecke nach den Seiten

3) gleichseitiges Dreieck

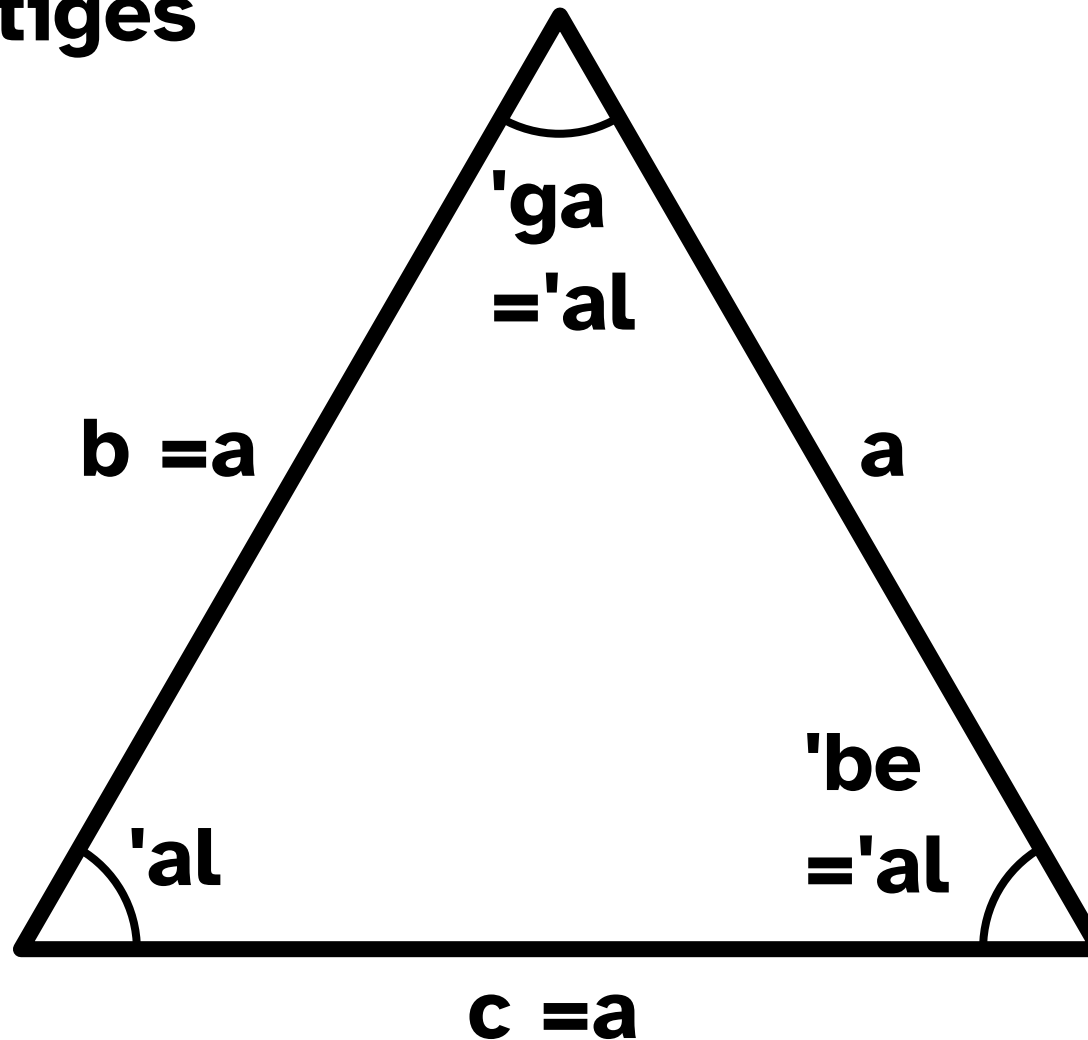

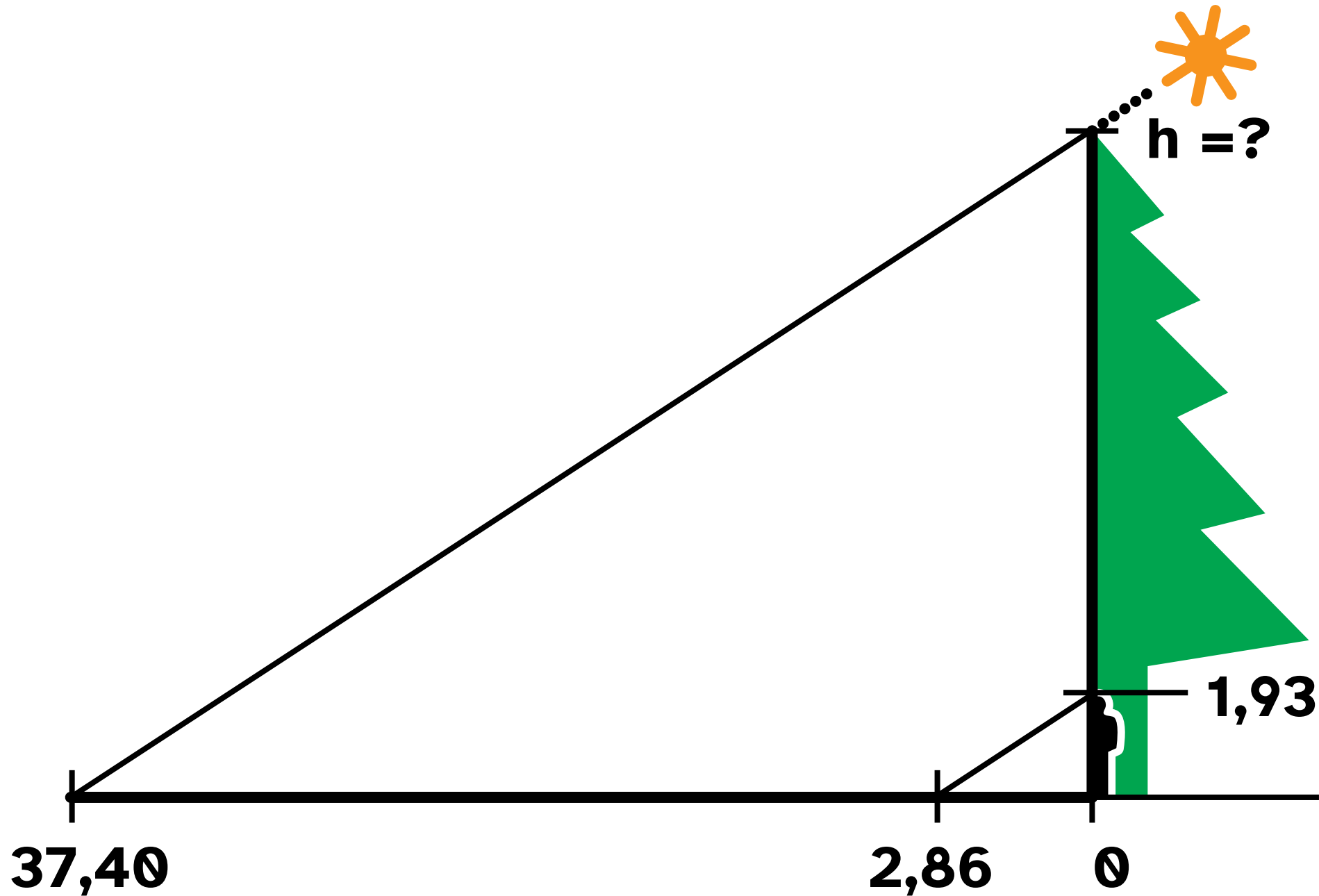
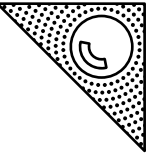

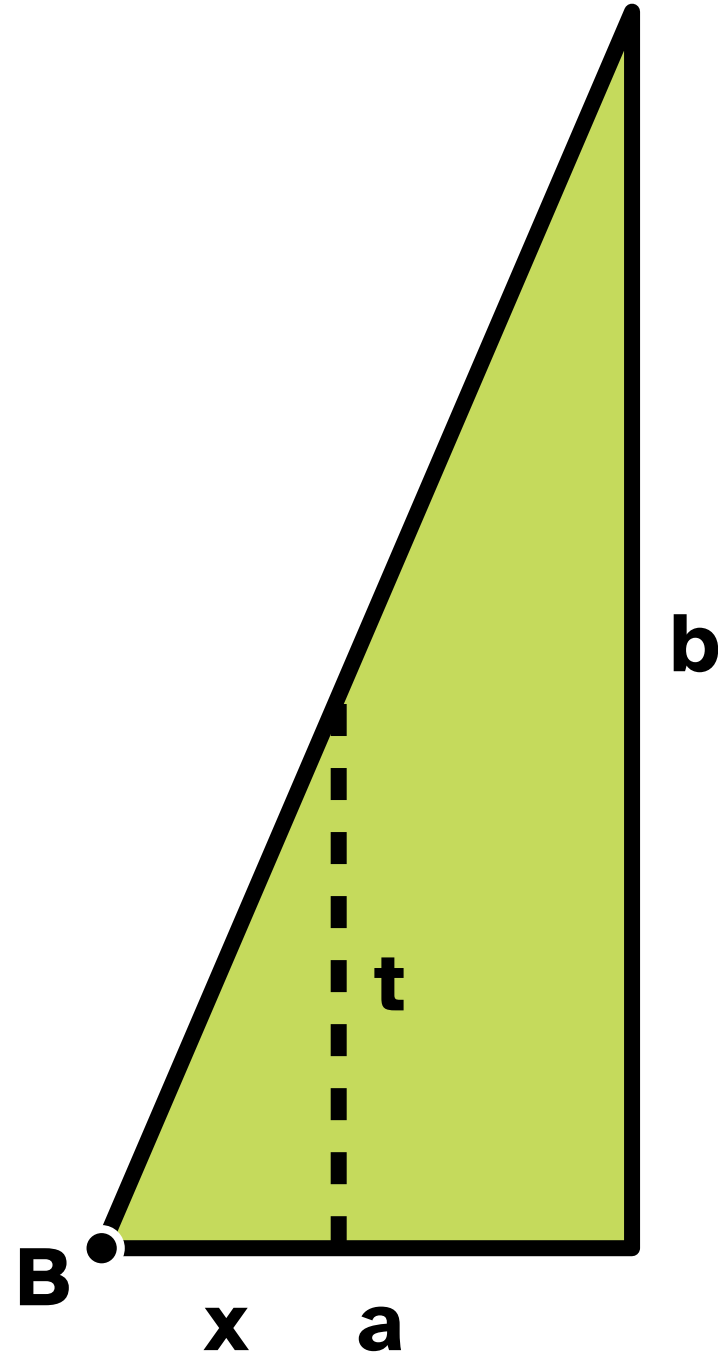
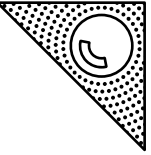

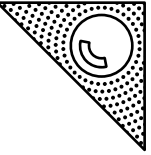

Kreis

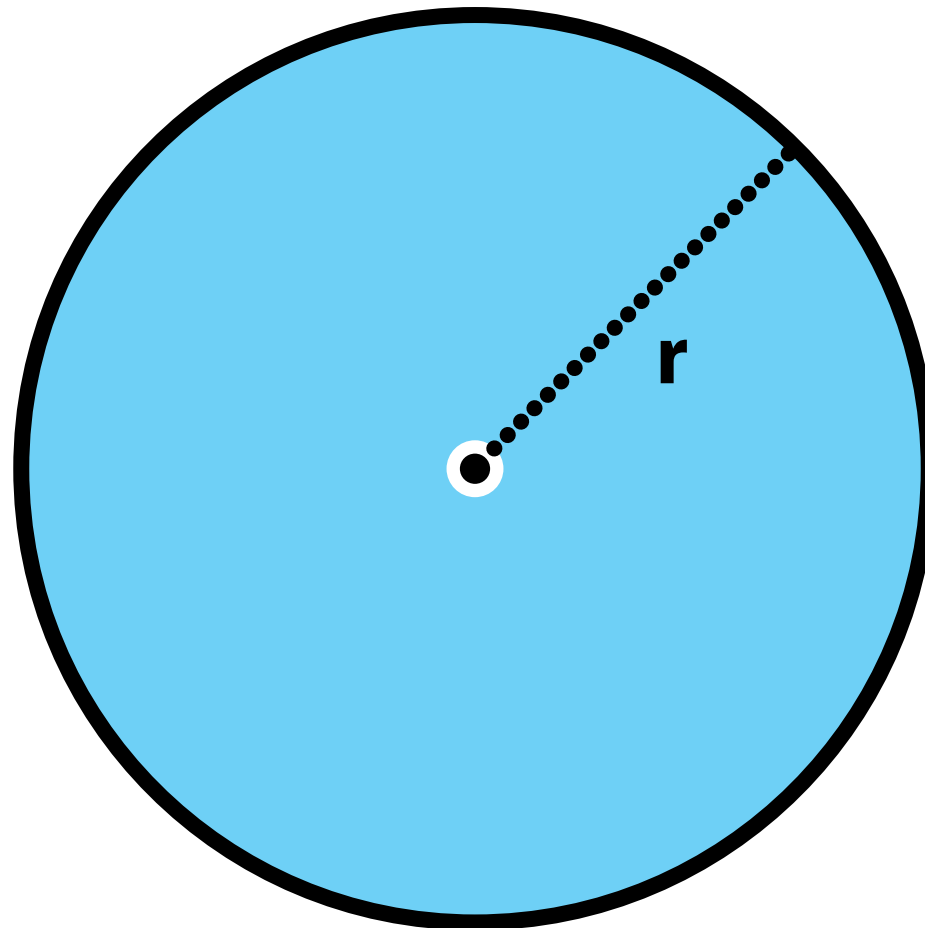

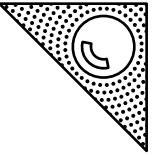

Kreissektor (Kreisausschnitt)

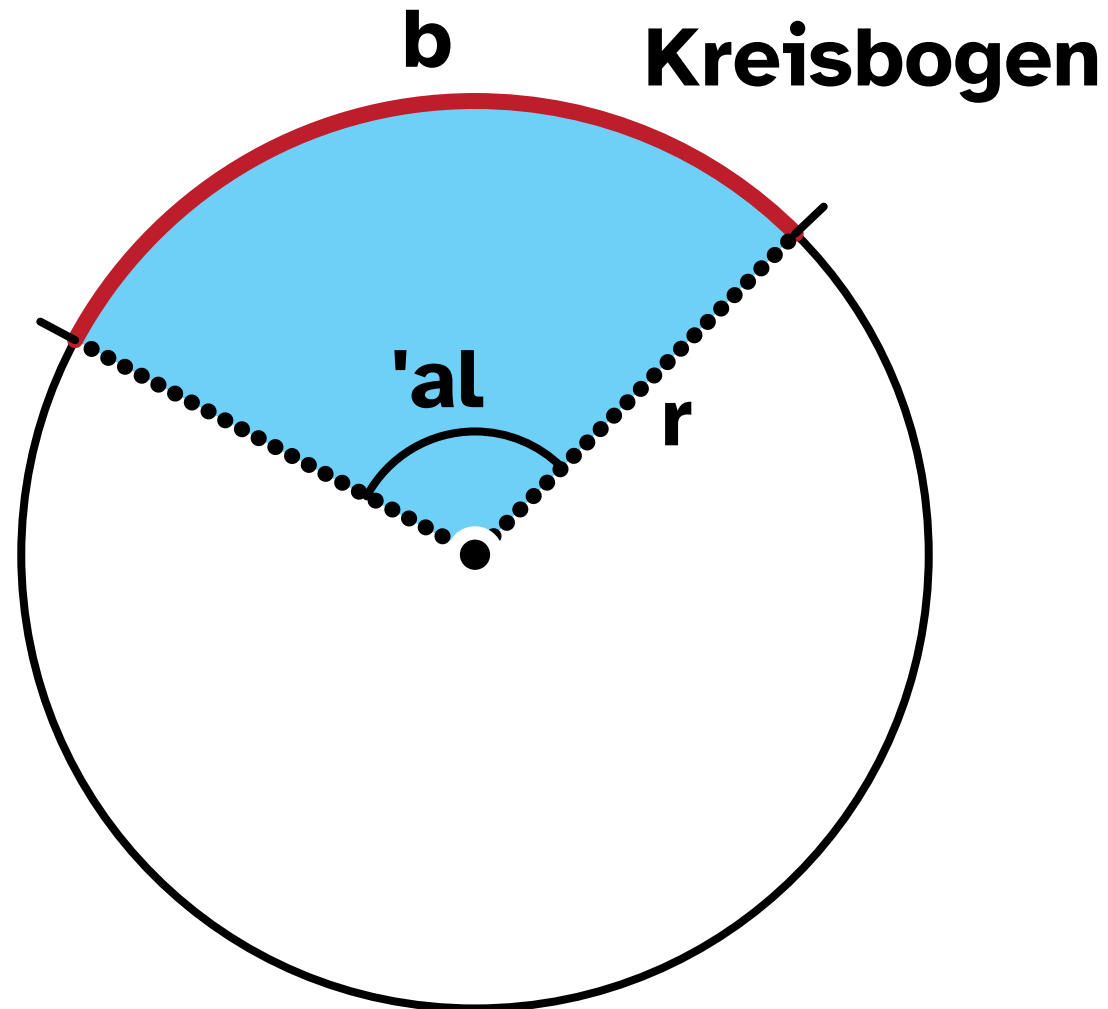

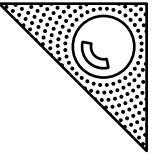

Kreissegment (Kreisabschnitt)

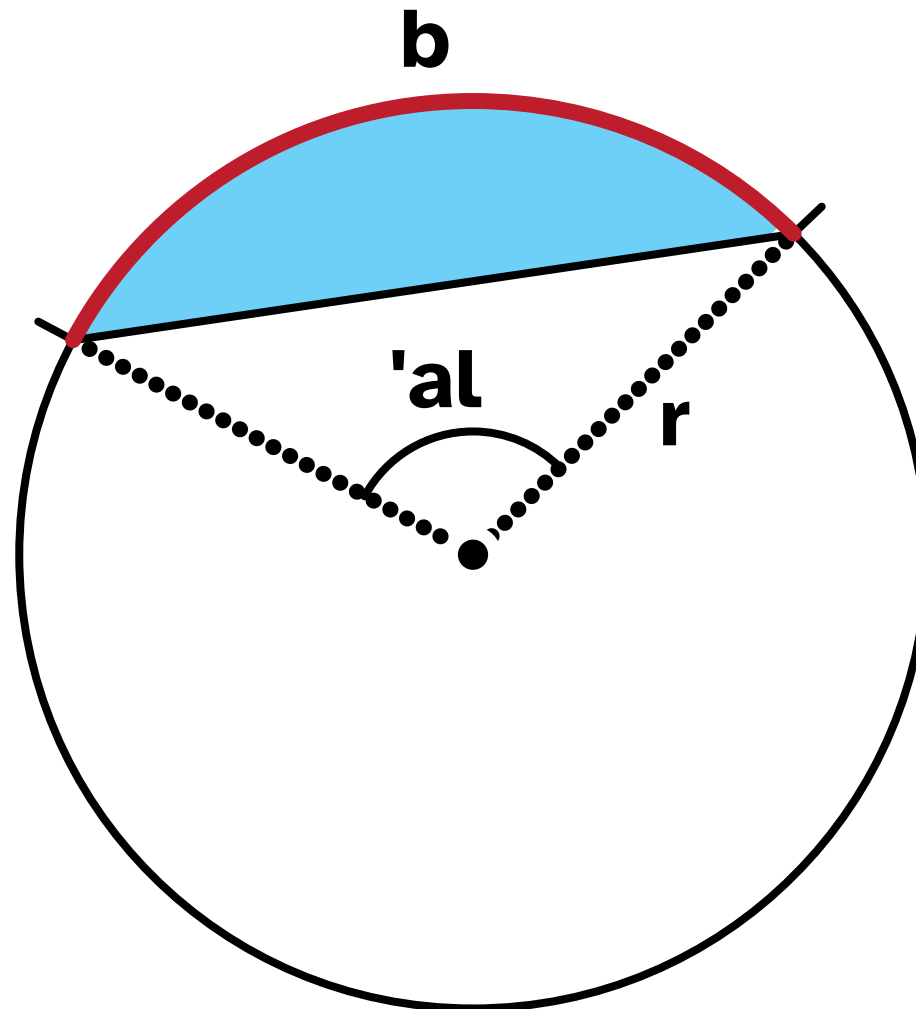

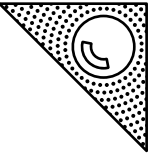

Bezeichnungen im rechtwinkligen Dreieck

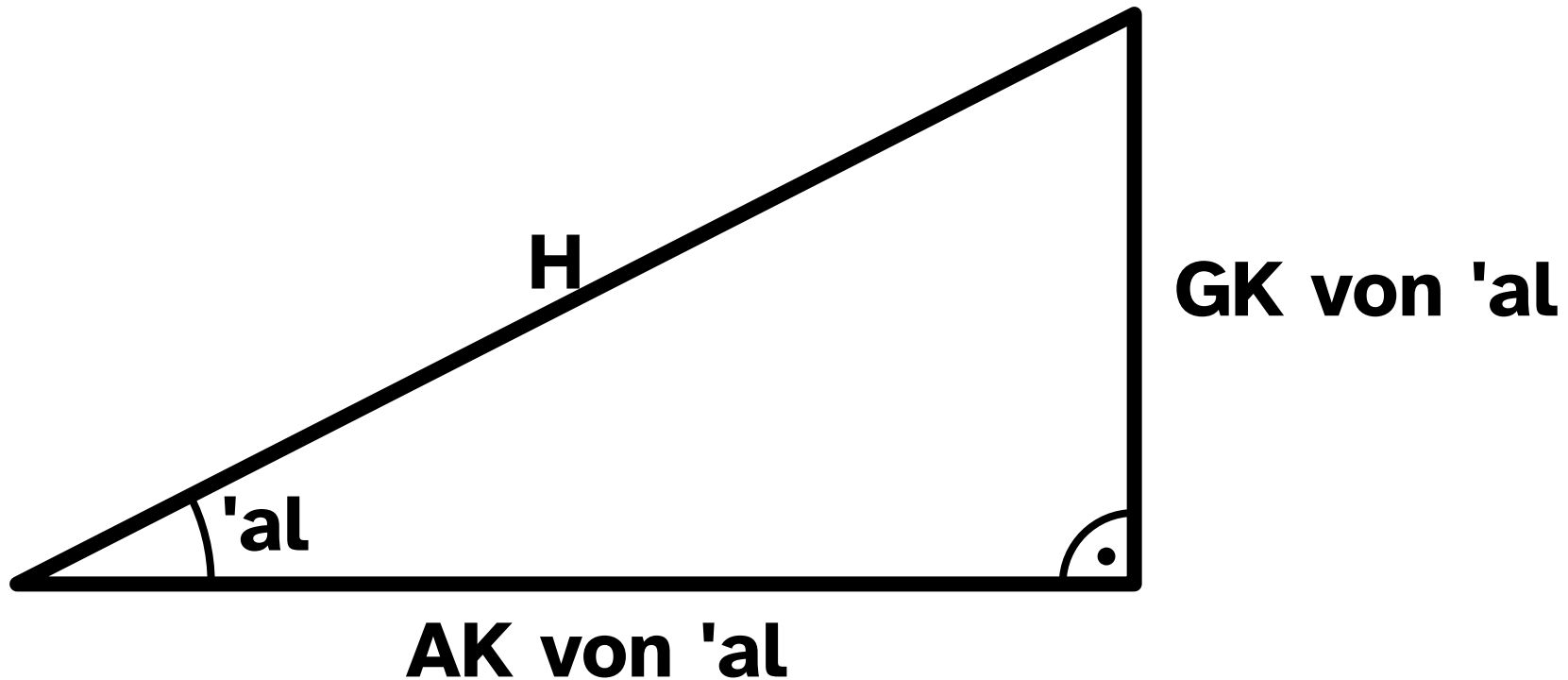

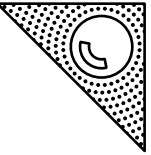

Seitenverhältnisse im rechtwinkligen Dreieck

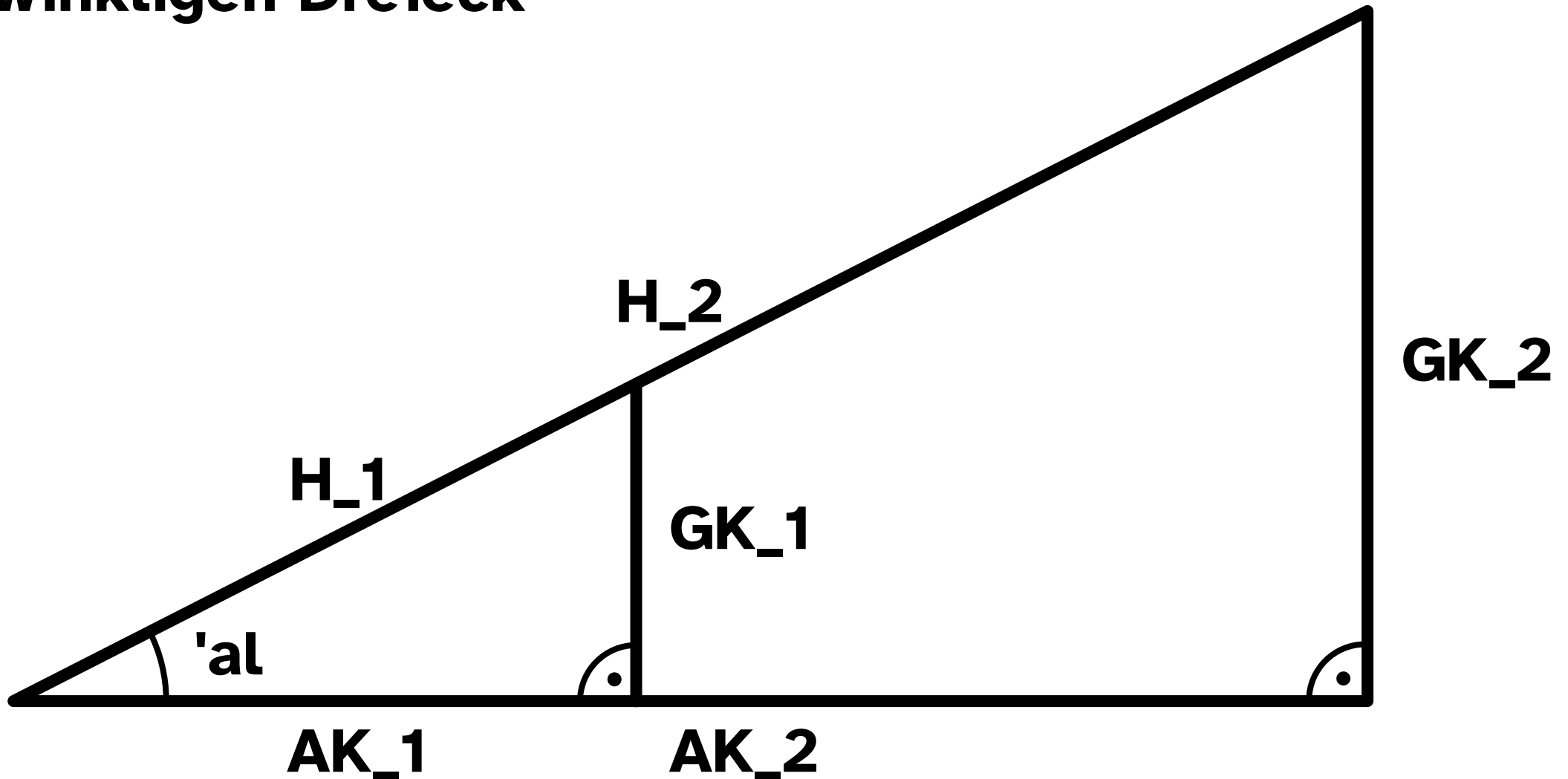

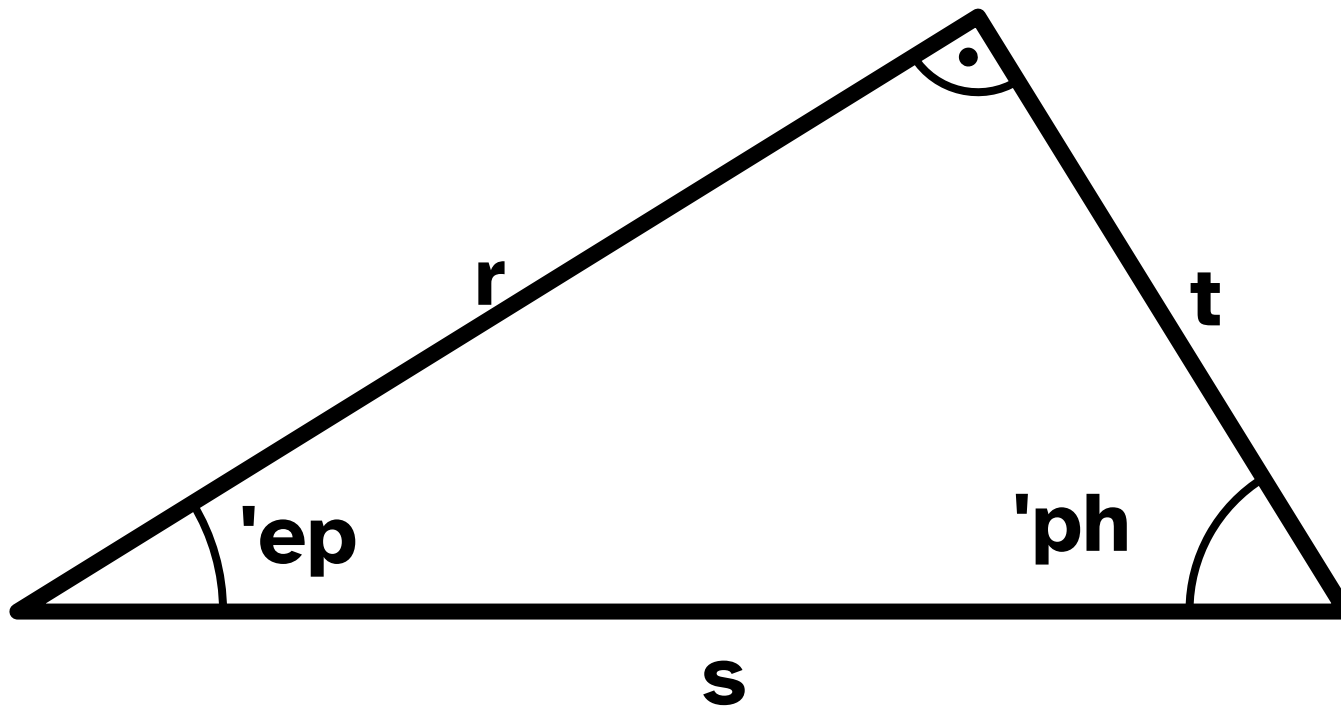
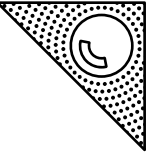

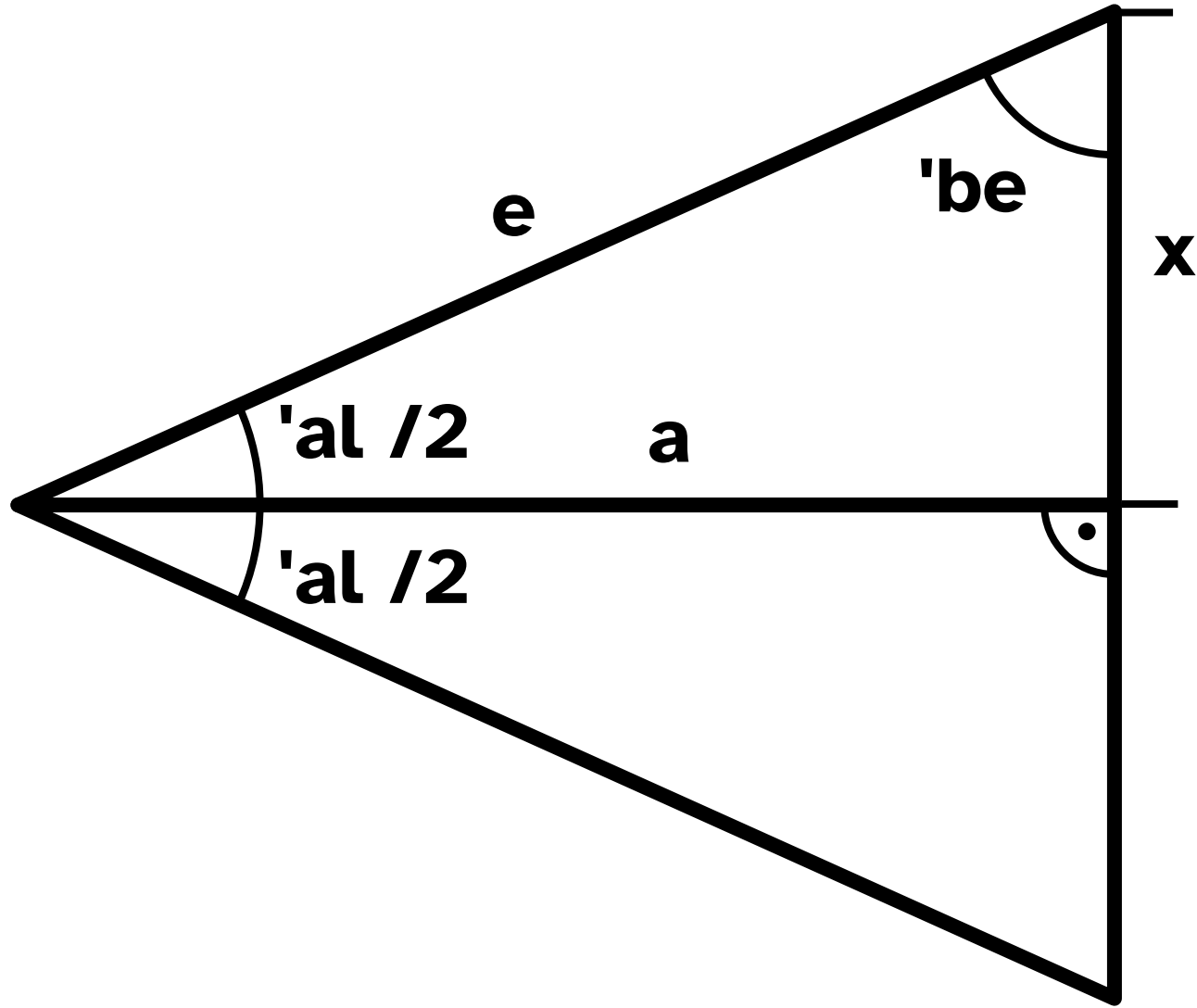
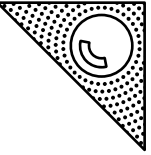

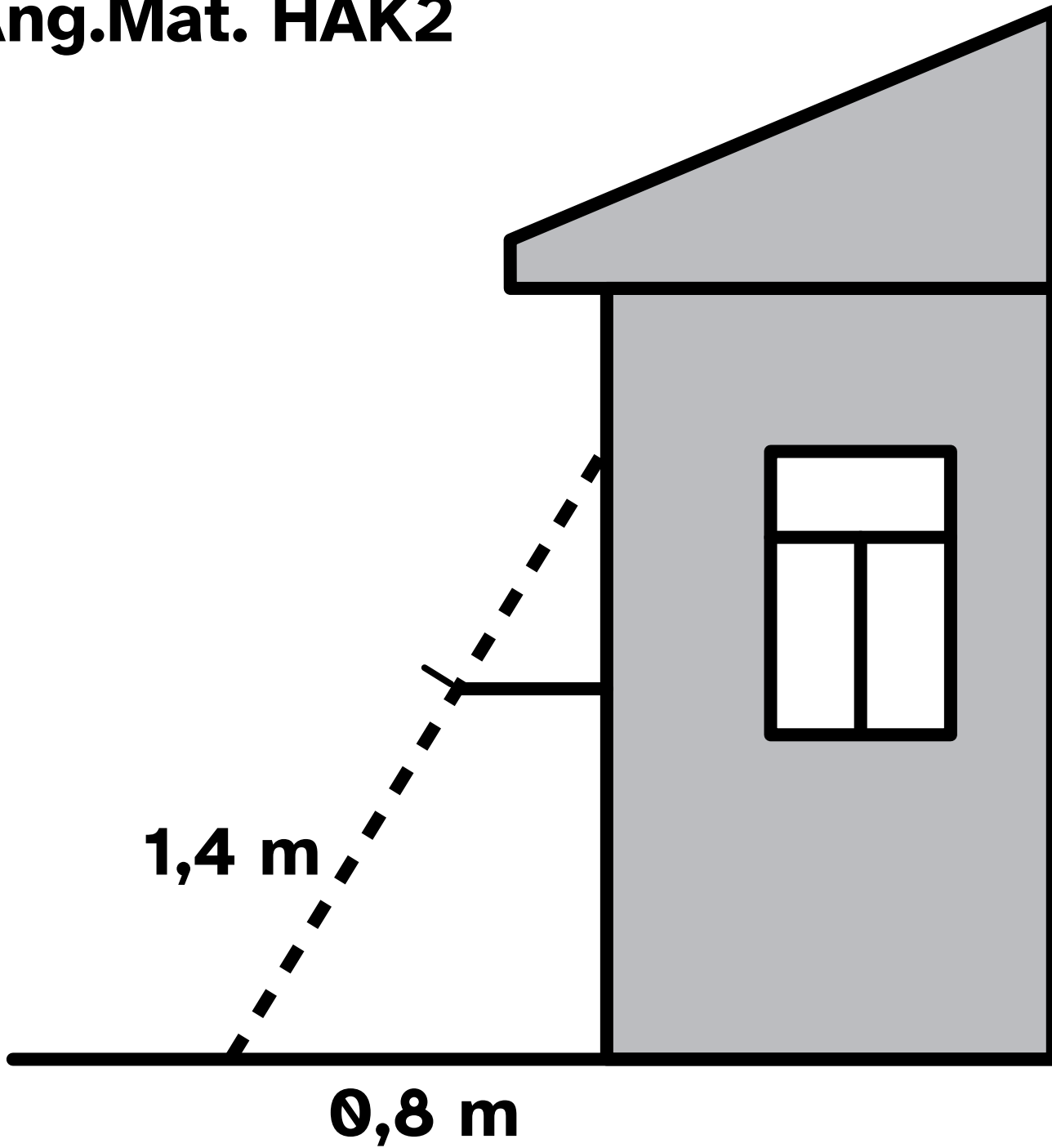
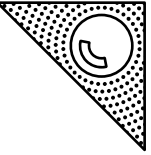

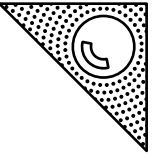

Lösung

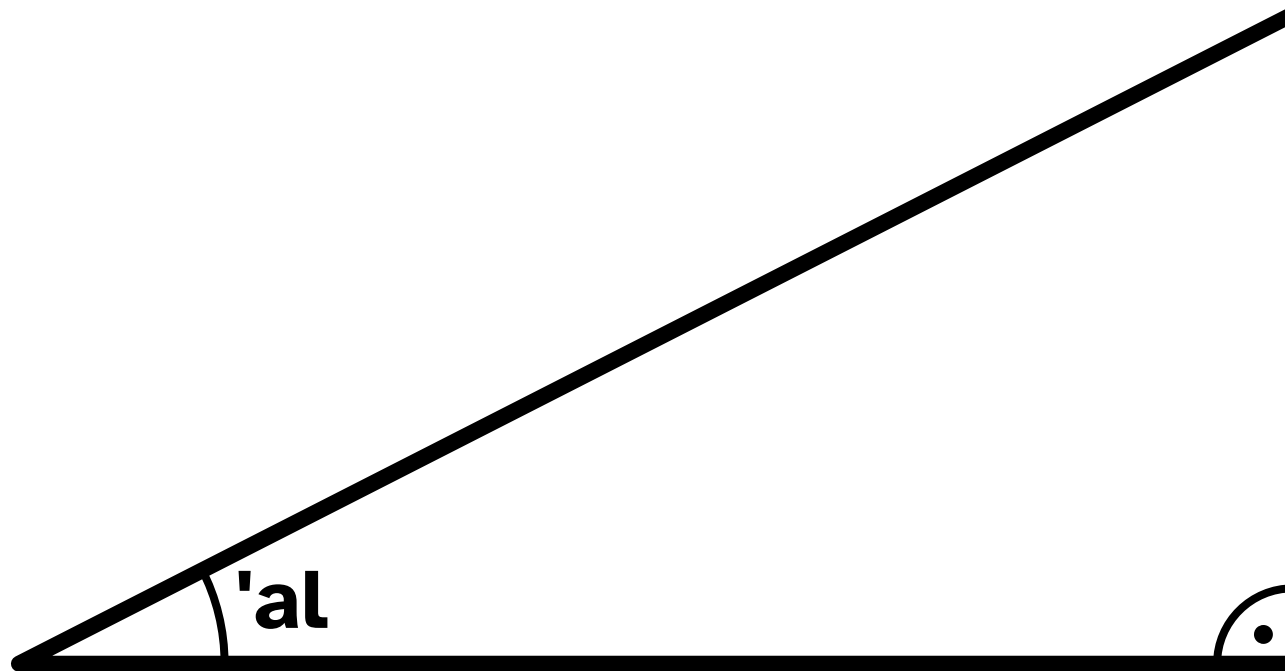

100 cm

Horizontalfentfernung

= AK von 'al

6 cm

Höhenunterschied

= GK von 'al

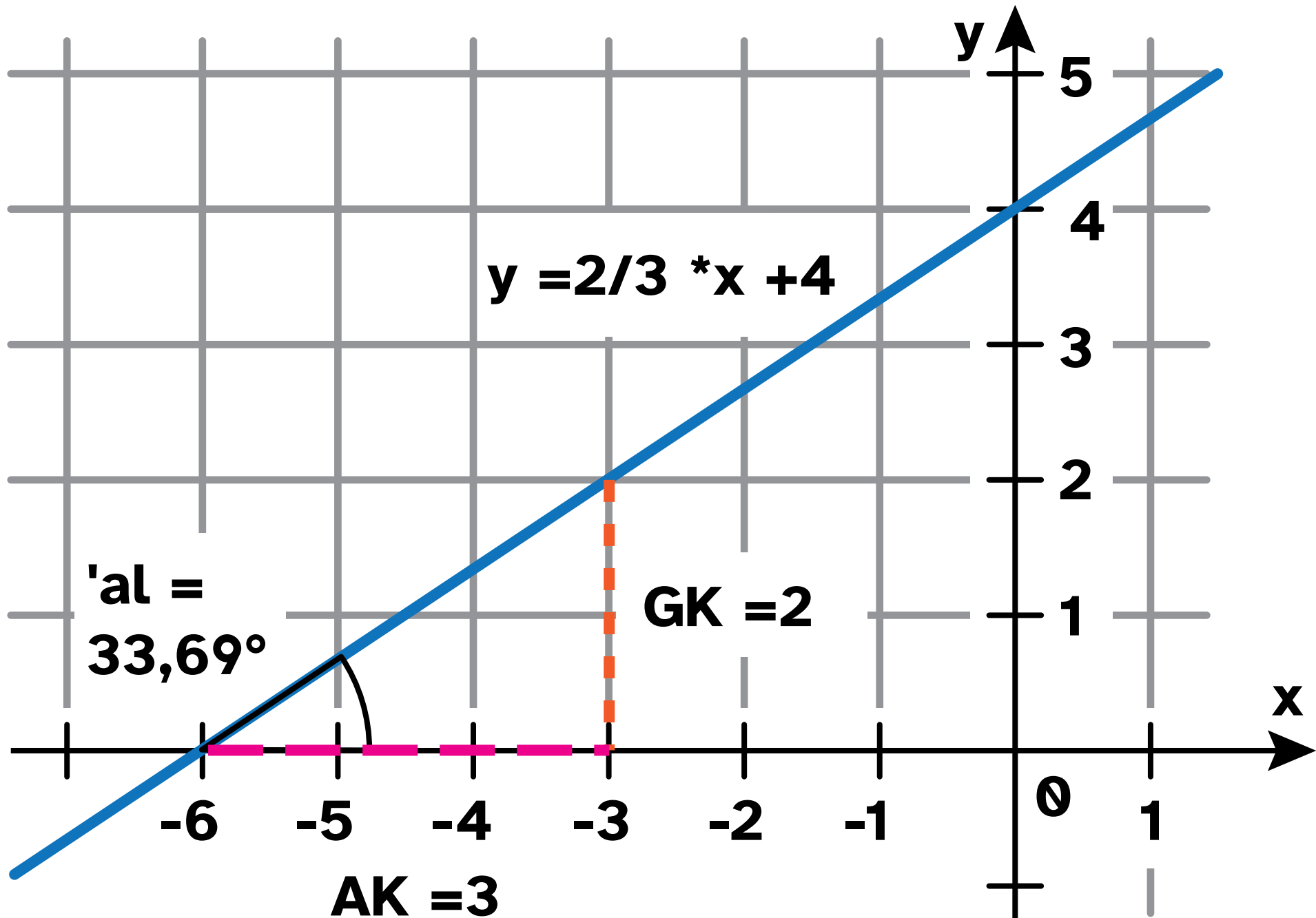
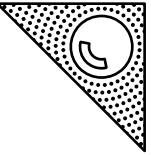

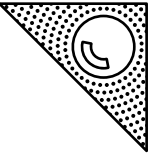

Sinus im Einheitskreis

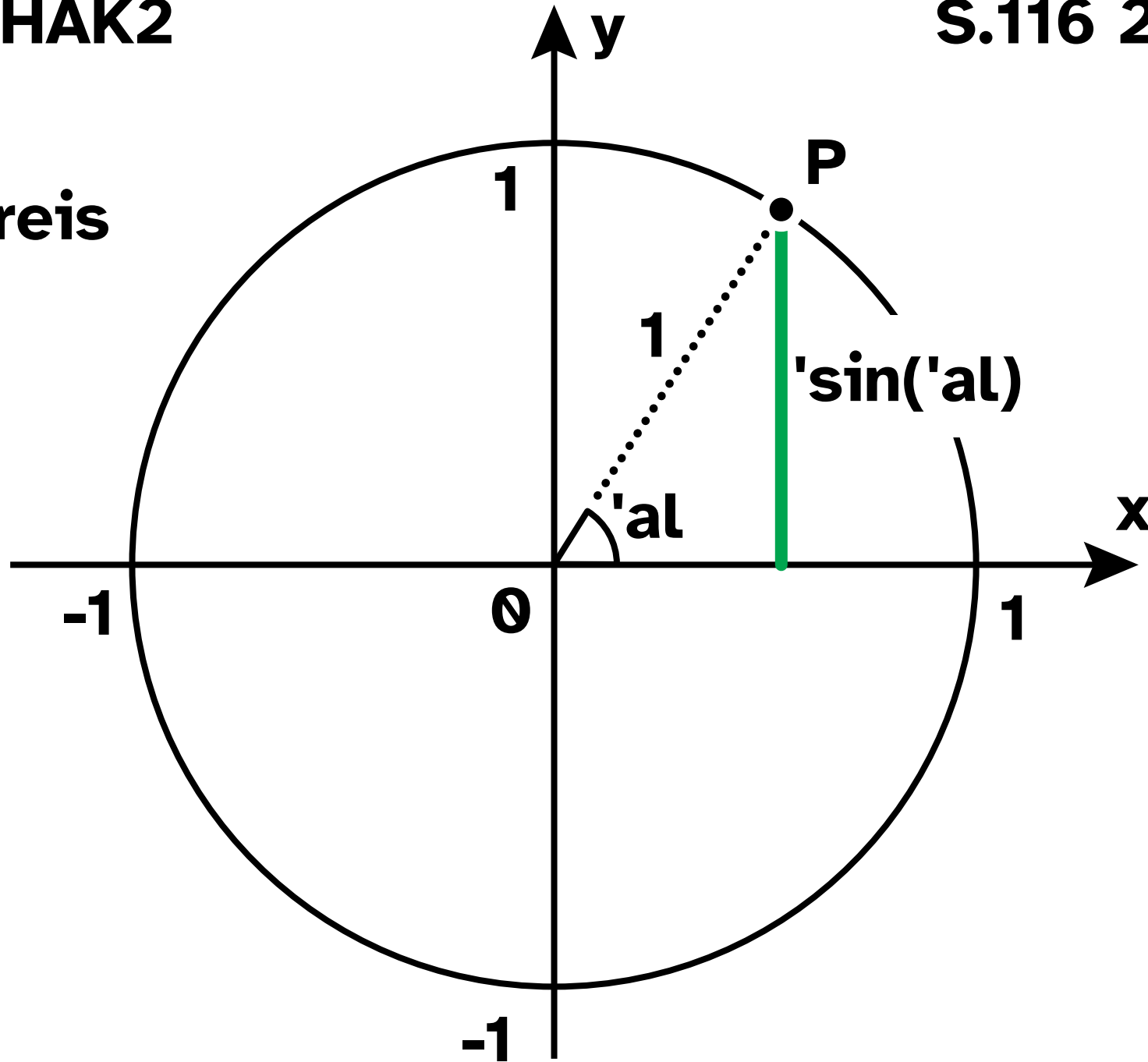

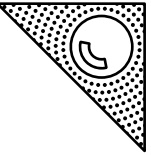

Cosinus im Einheitskreis

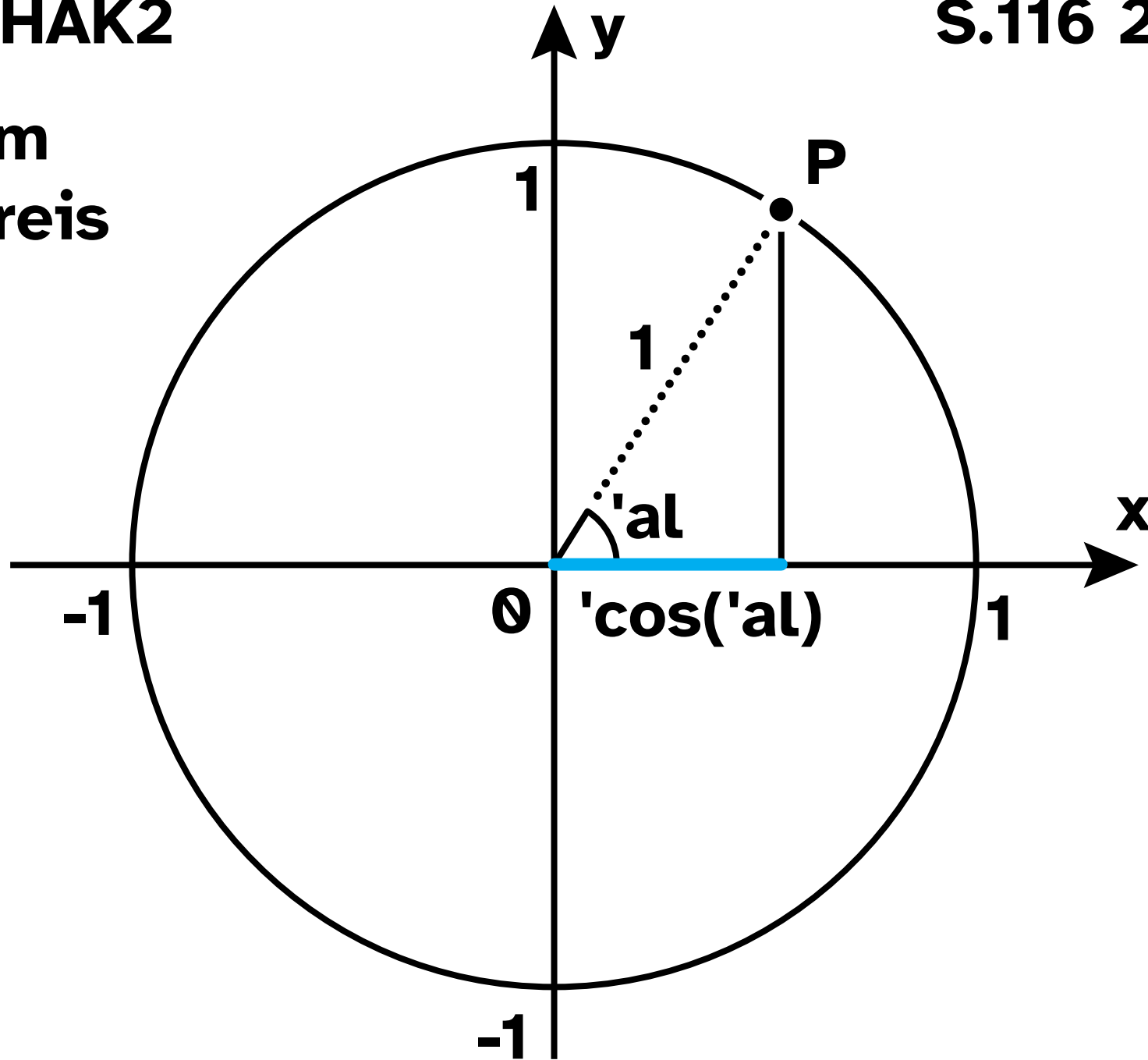

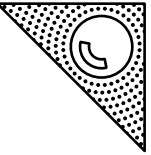

Tangens im
Einheitskreis

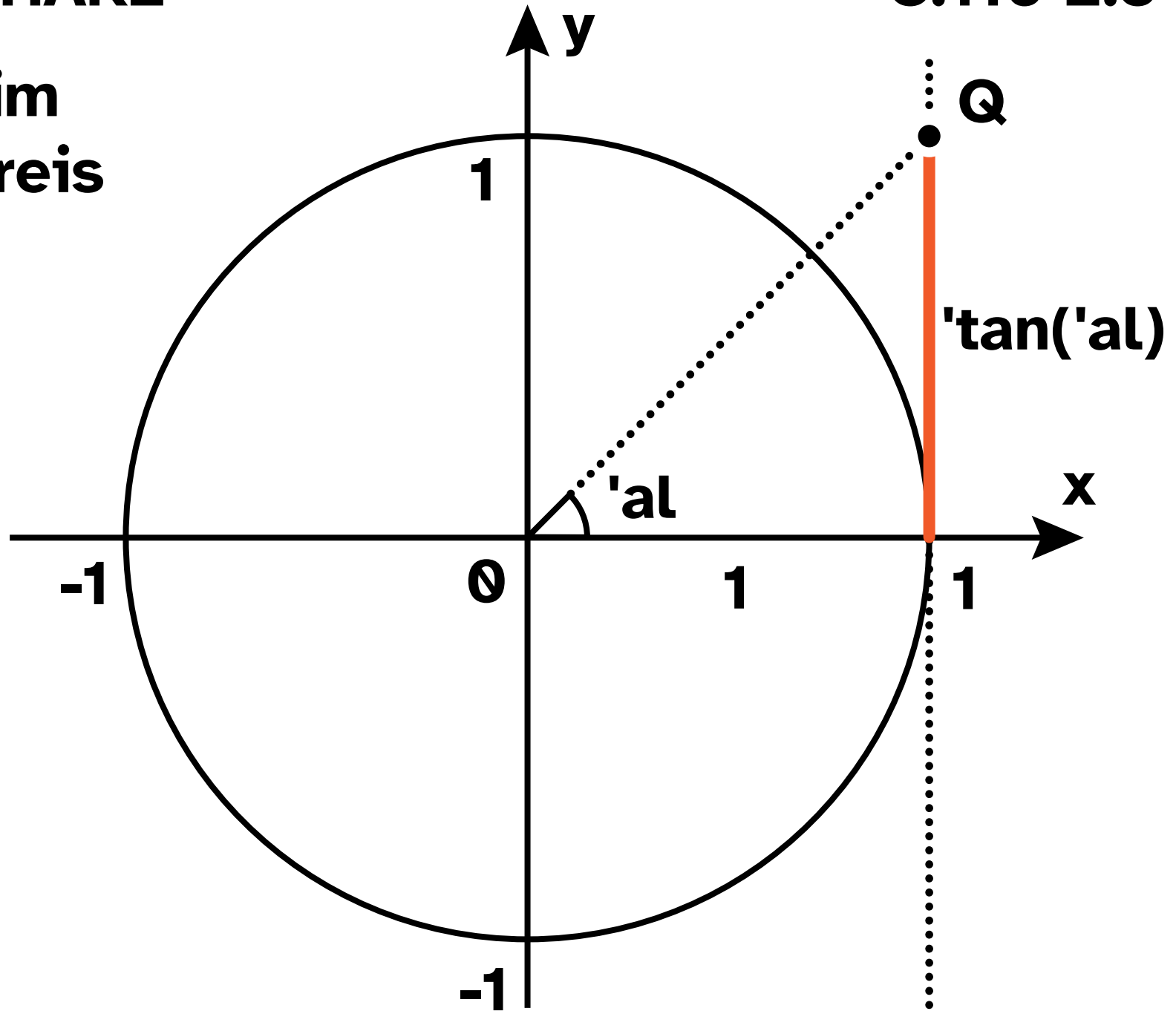

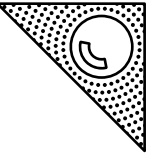

$90^\circ < \alpha < 180^\circ$

'sin('α): 

'cos('α): 

'tan('α): 

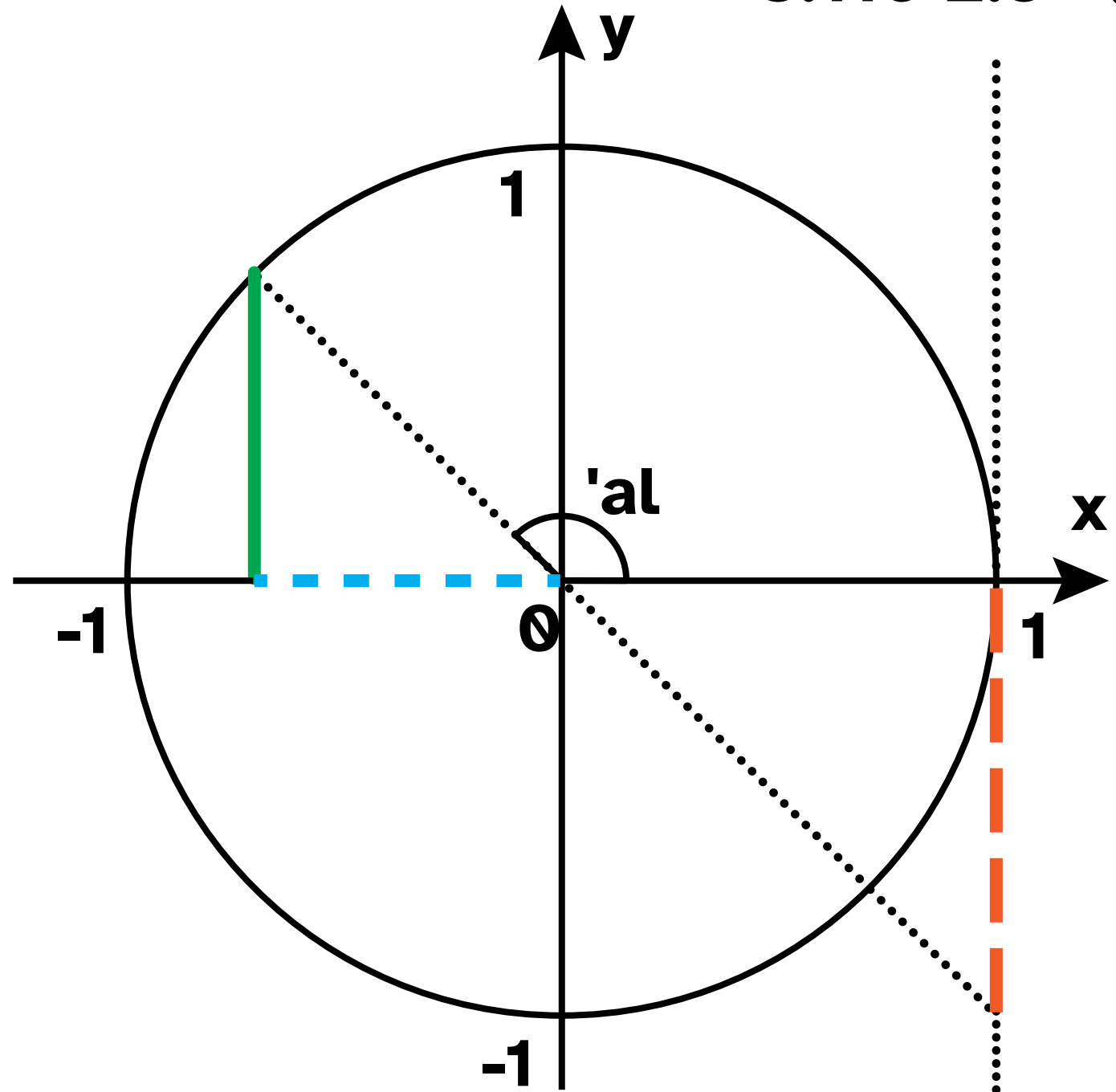

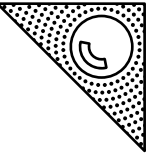

Ang.Mat. HAK2

S.116 2.3



$90^\circ < \alpha < 180^\circ$

'sin('al): 

'cos('al): 

'tan('al): 

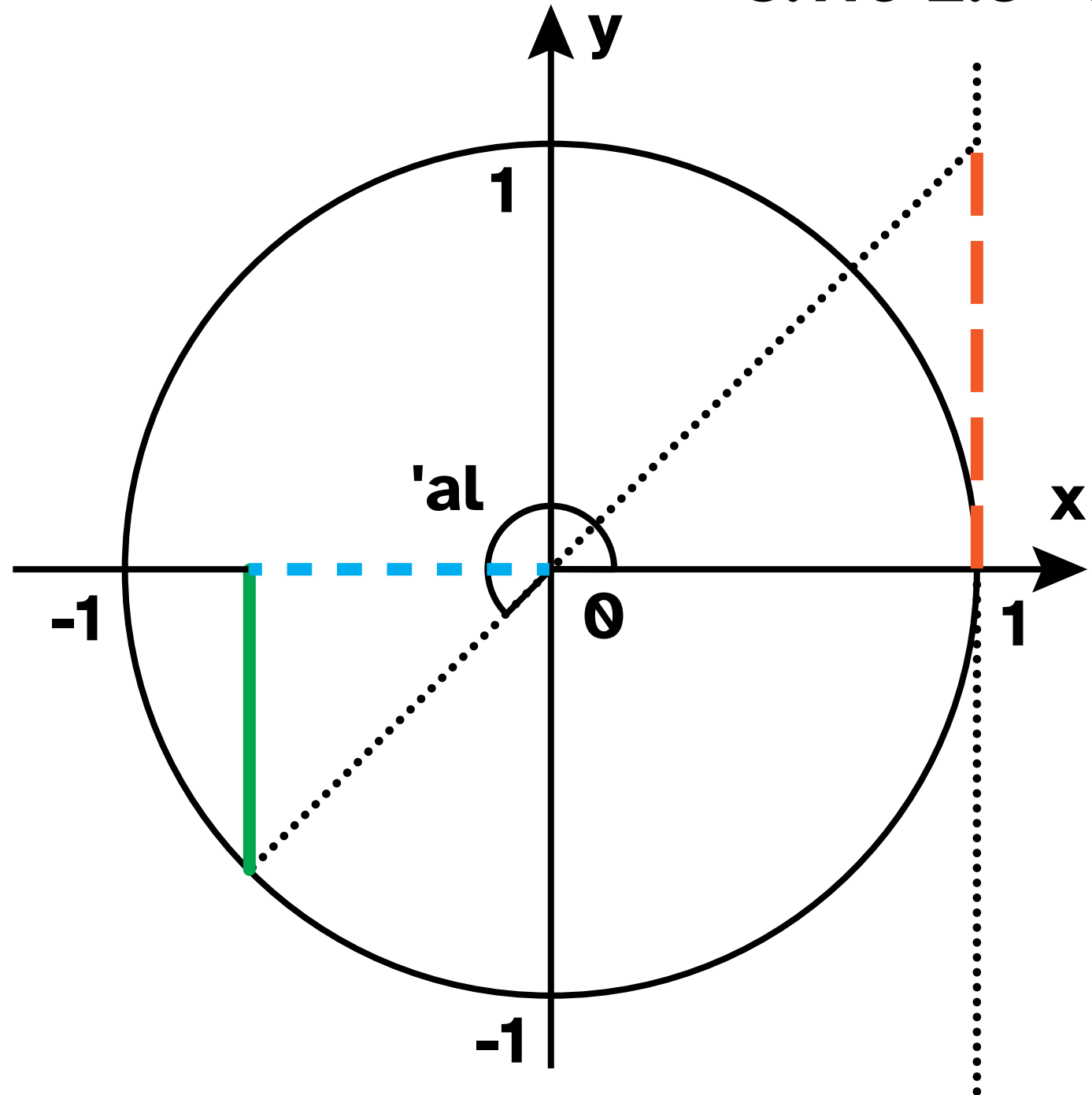

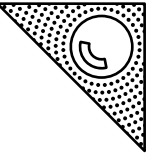

Ang.Mat. HAK2

S.116 2.3



$90^\circ < \alpha < 180^\circ$

'sin('al): 

'cos('al): 

'tan('al): 

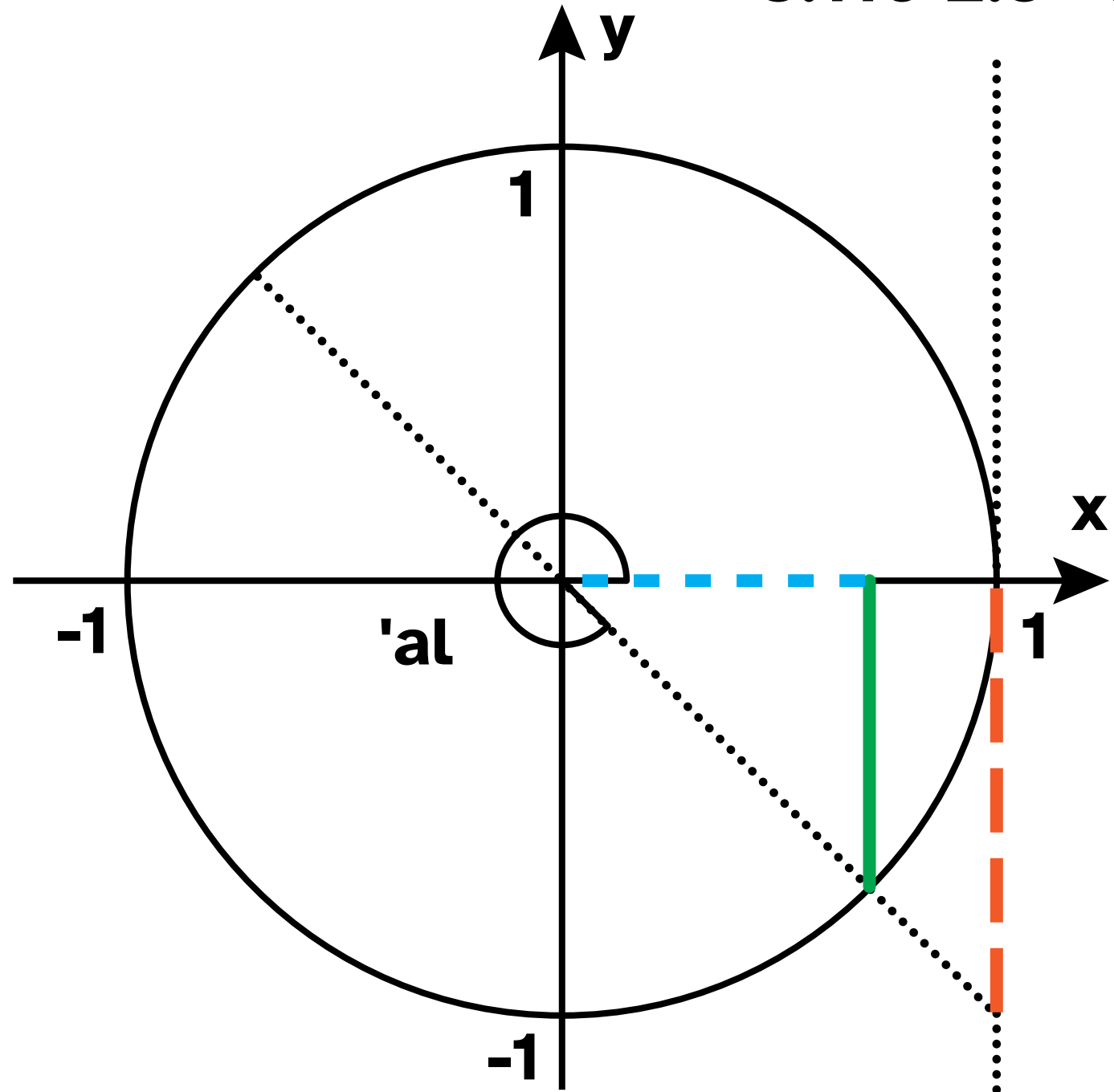

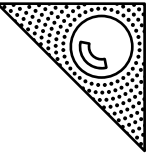

'sin('aL): 

'cos('aL): 

'tan('aL): 

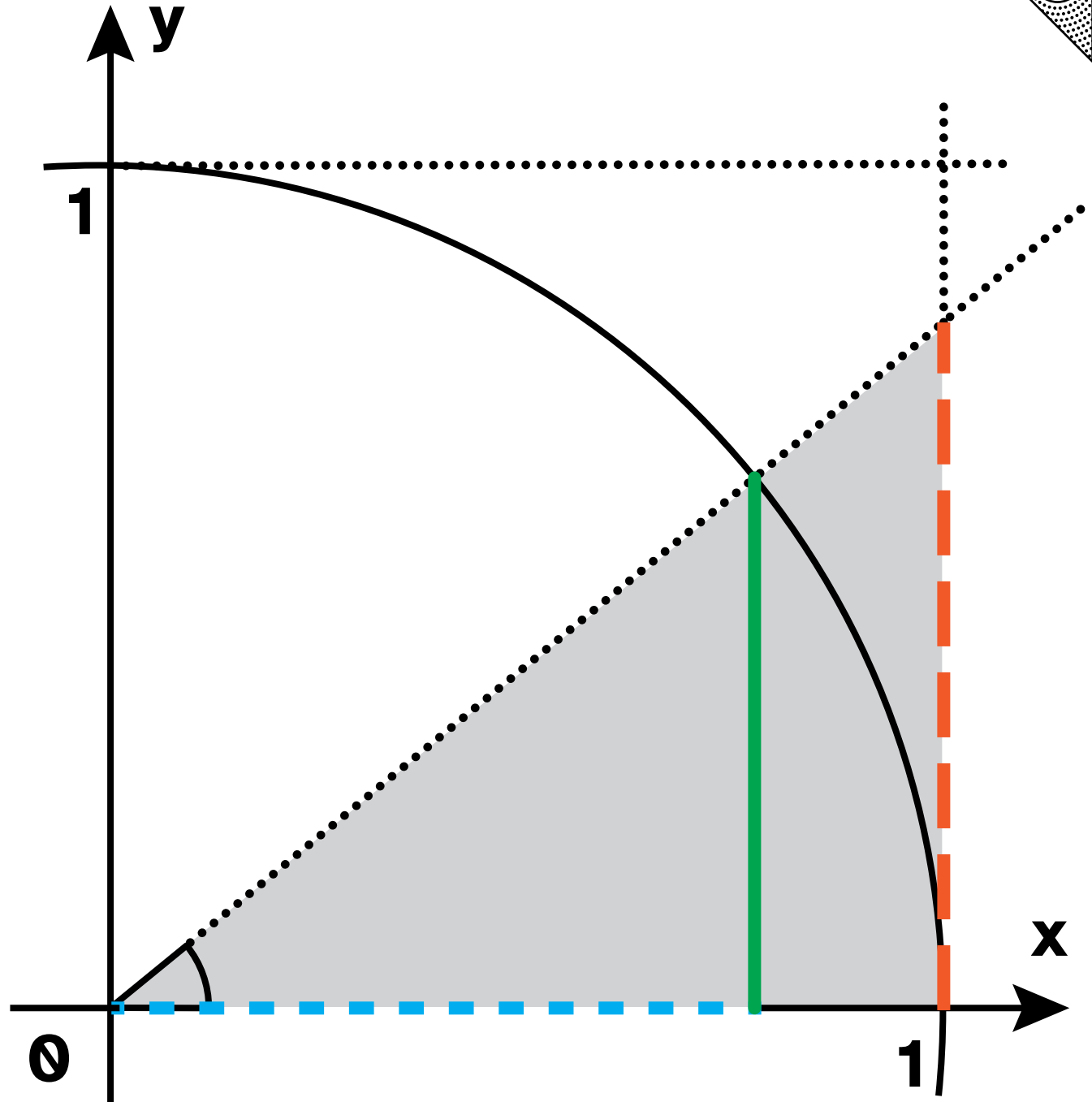

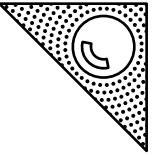

Cosinussatz

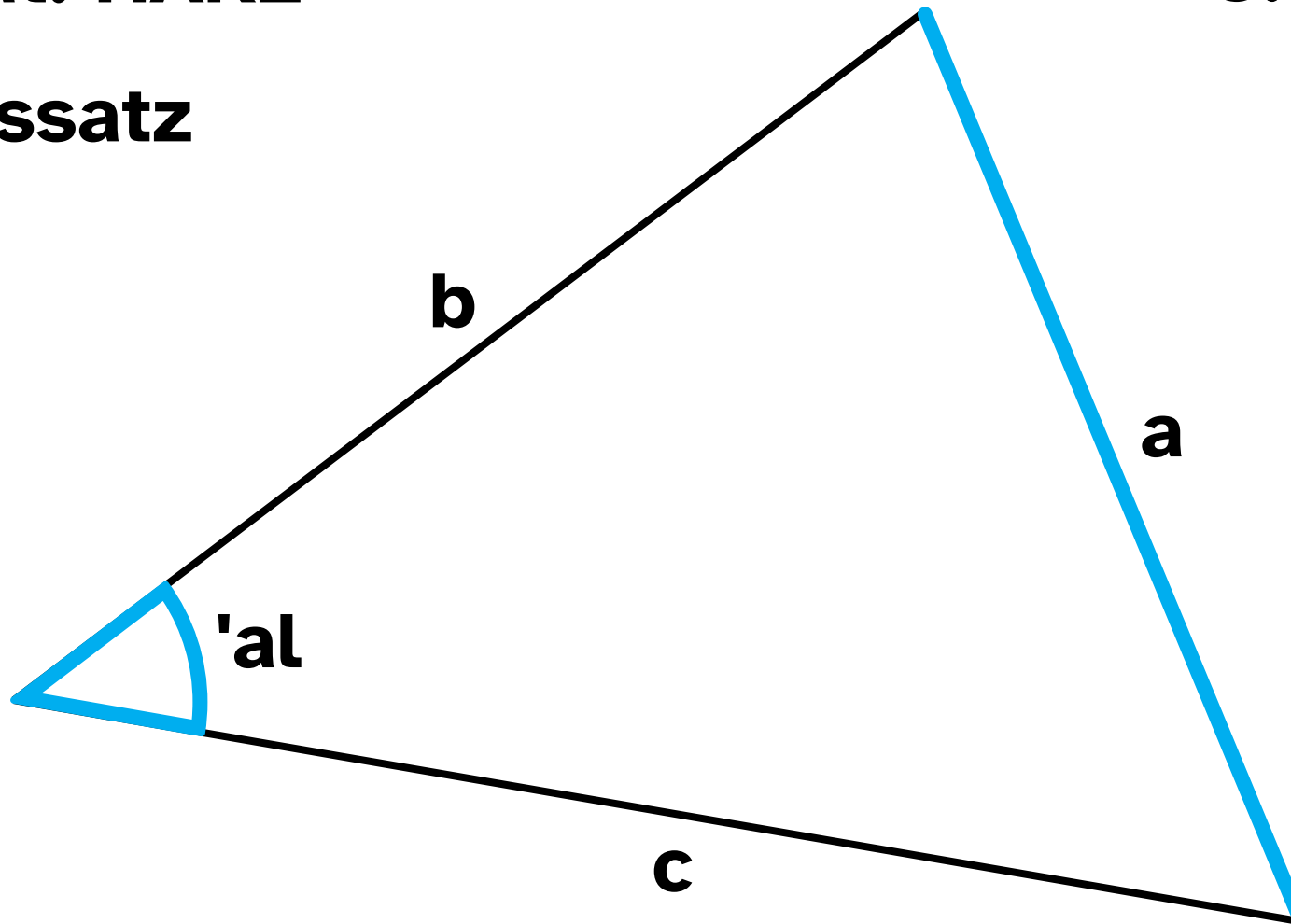

'al: von b und c eingeschlossener Winkel

a: dem Winkel 'al gegenüberliegende Seite

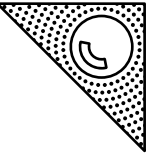

SSW-Satz

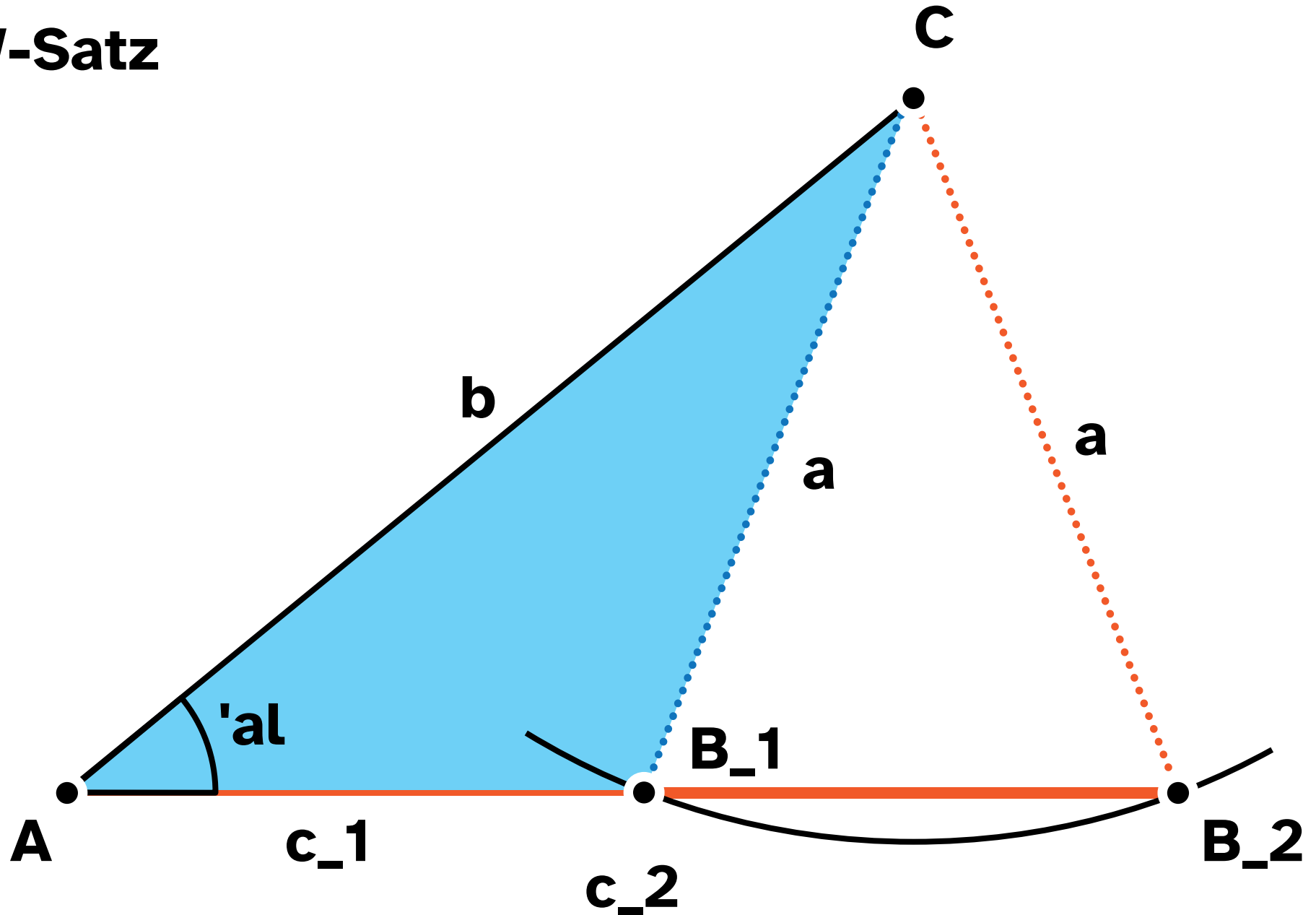

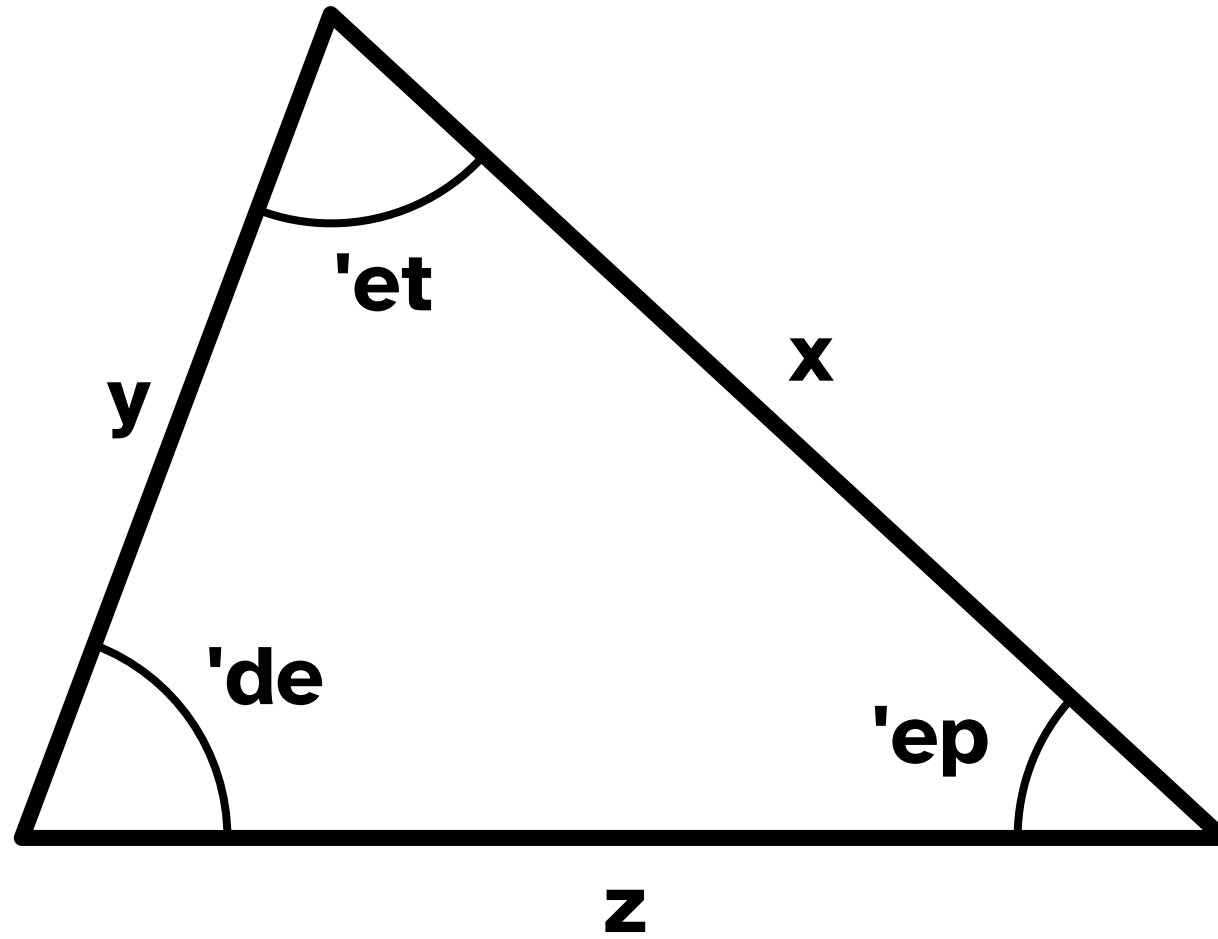
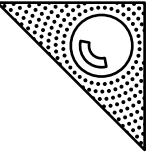

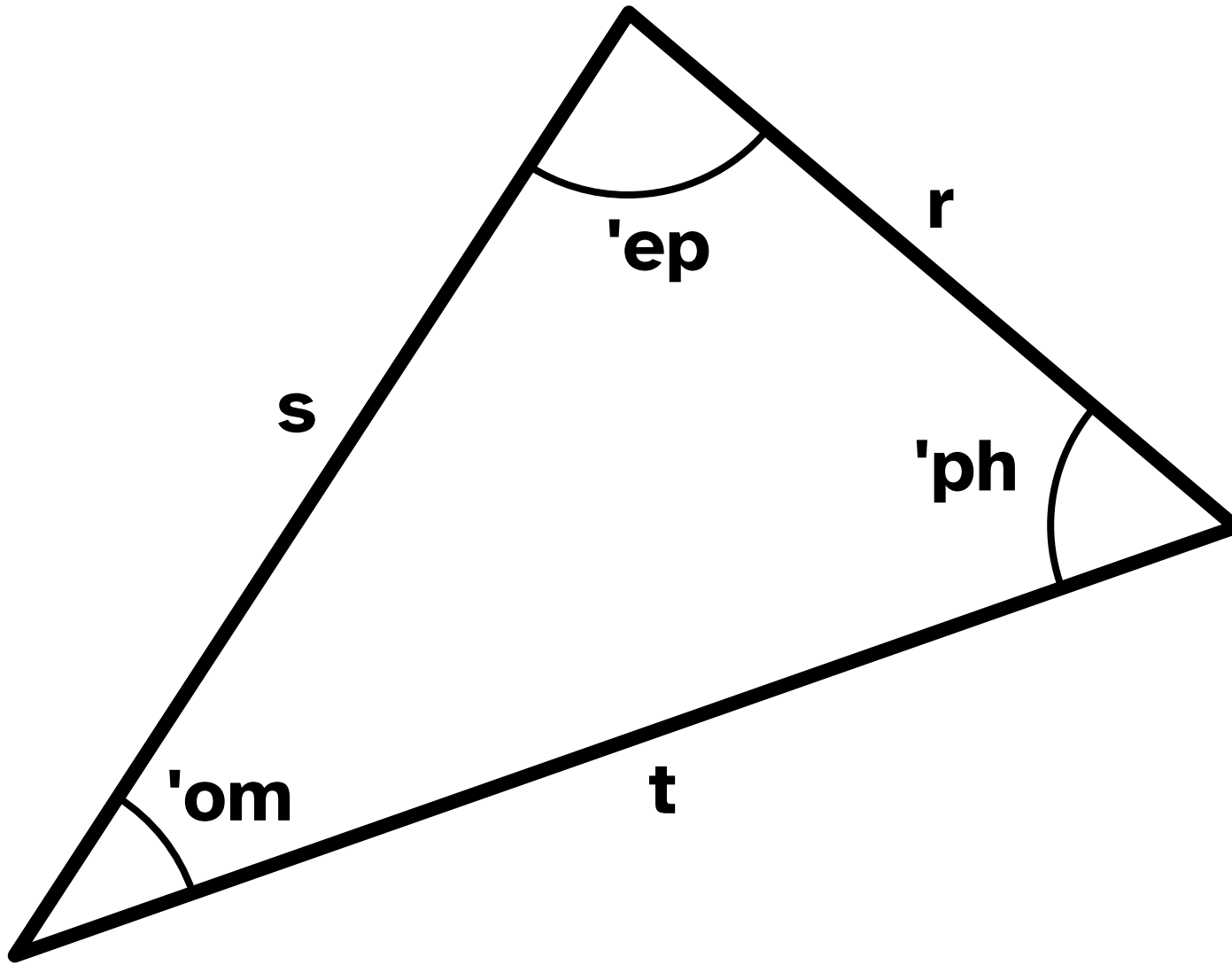
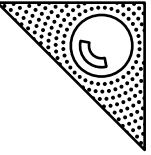

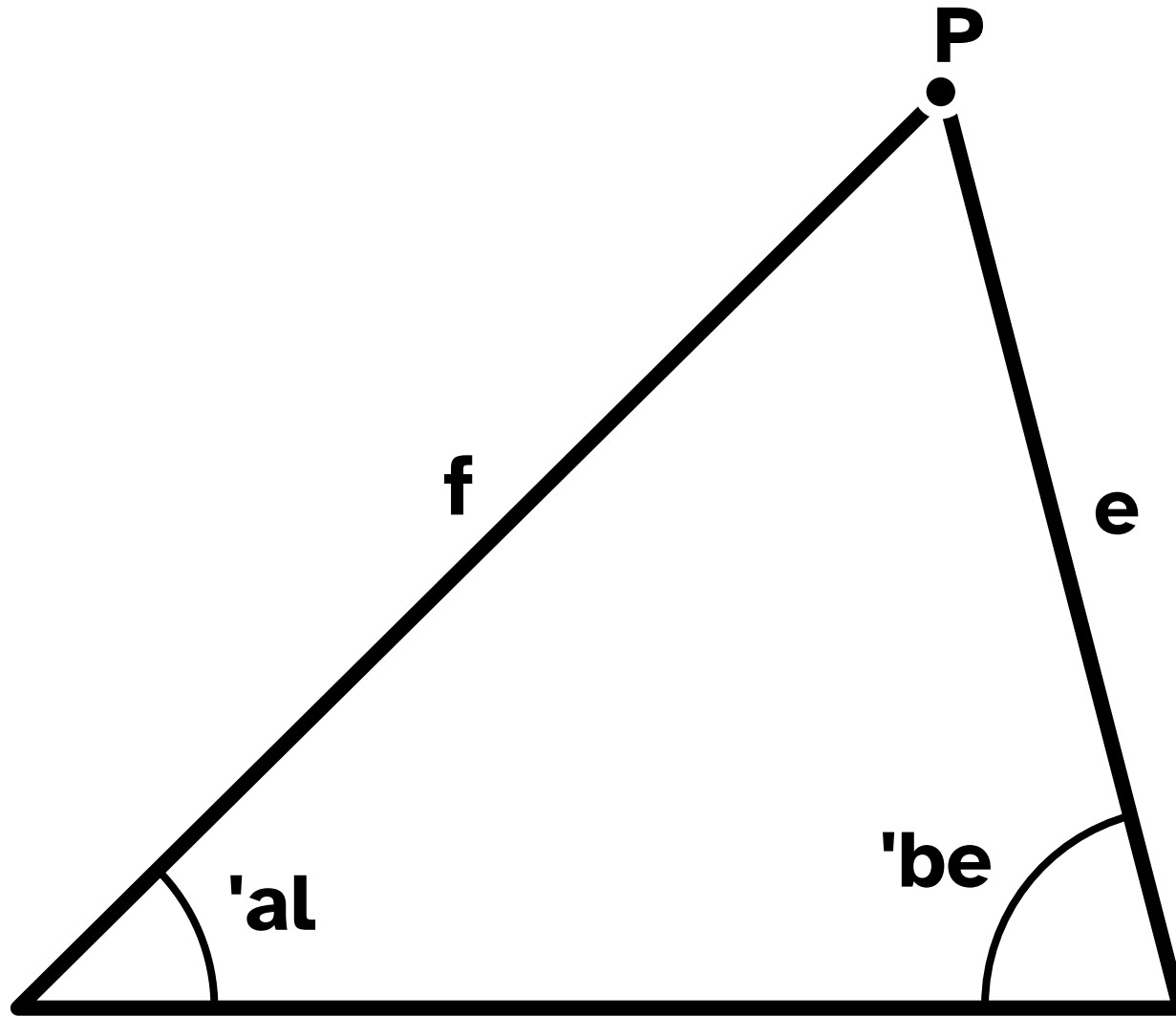
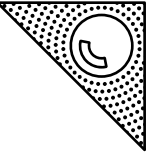

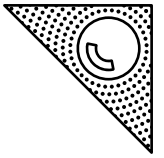

**Angewandte Mathematik
HAK Band 2**

**5.
Trigonometrie**

Teil 2, Seiten 120 - 138

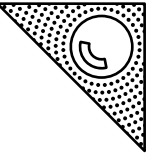

Sehwinkel



Höhenwinkel

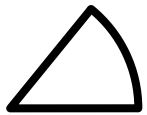

Tiefenwinkel

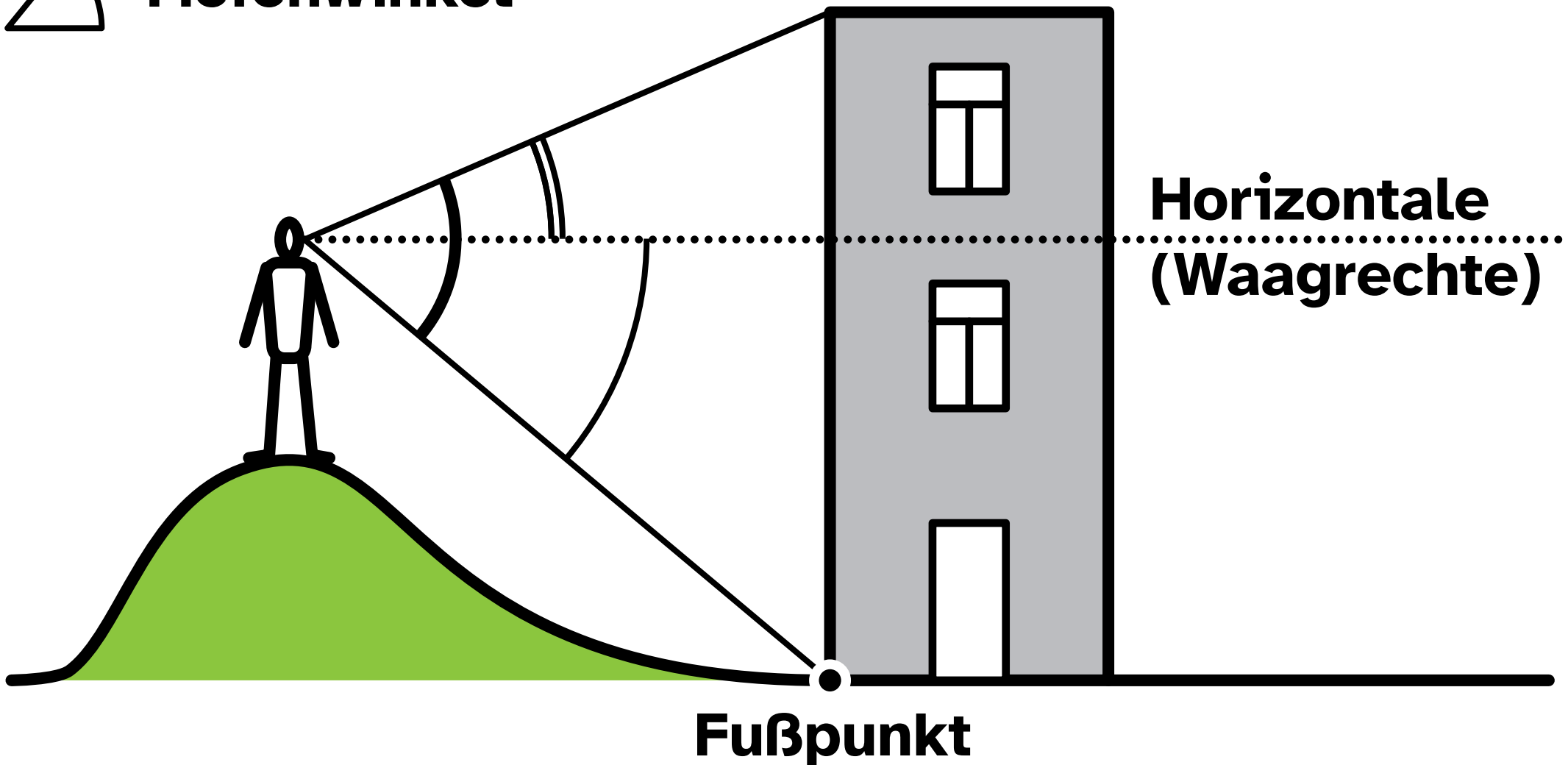

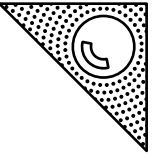

Lösung

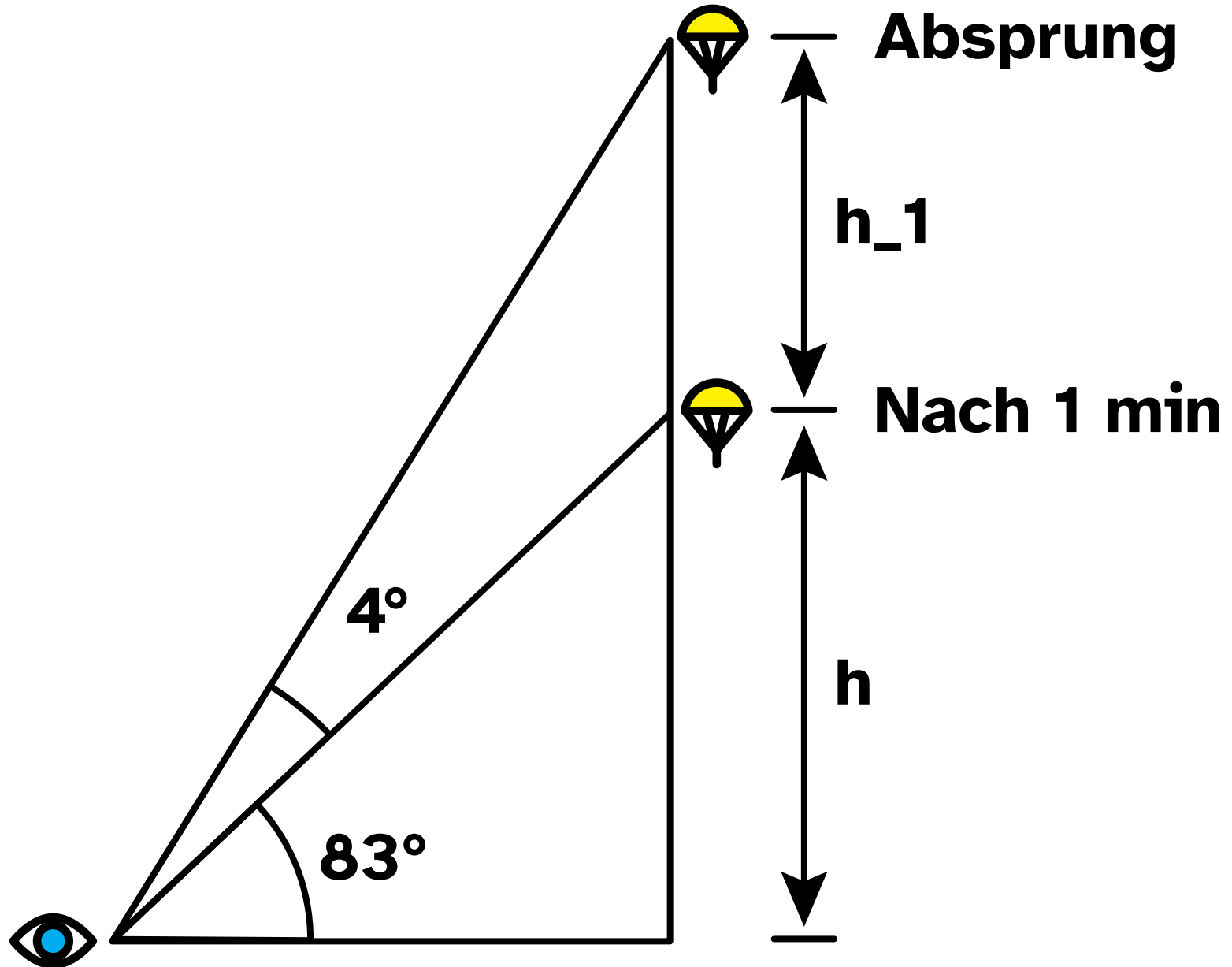

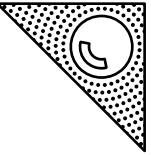

Lösung

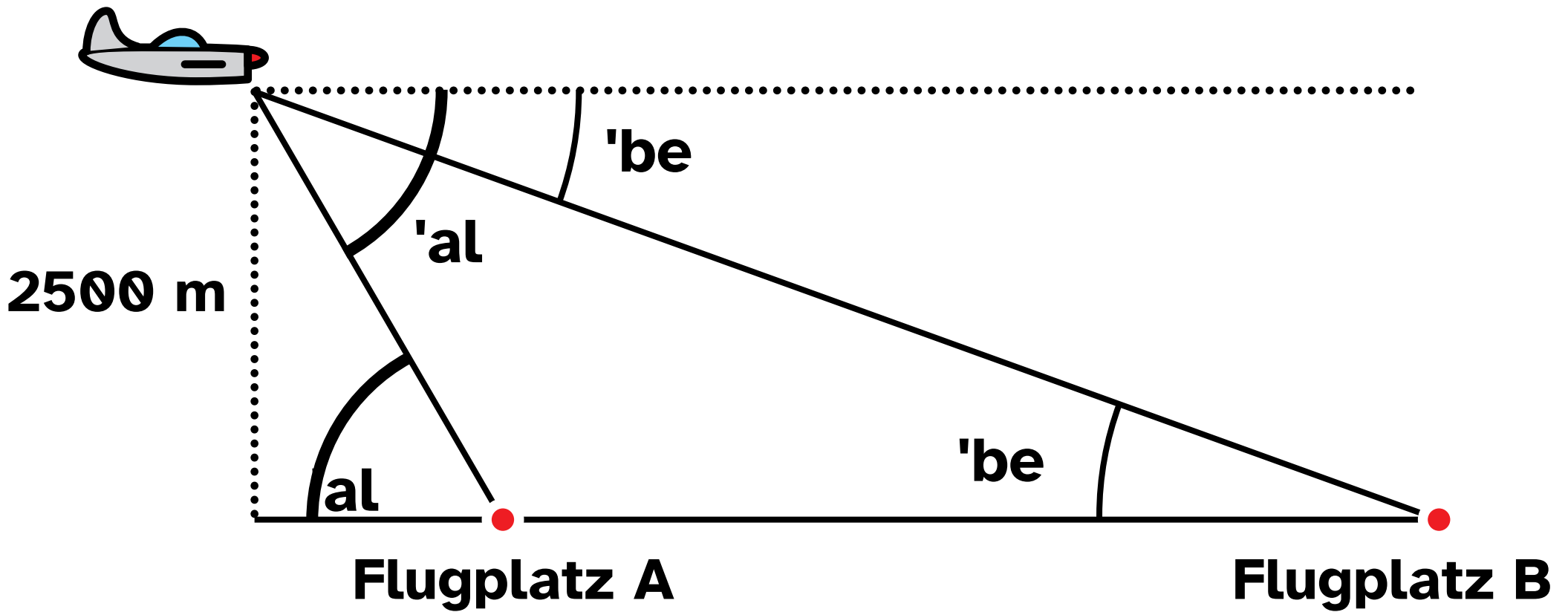

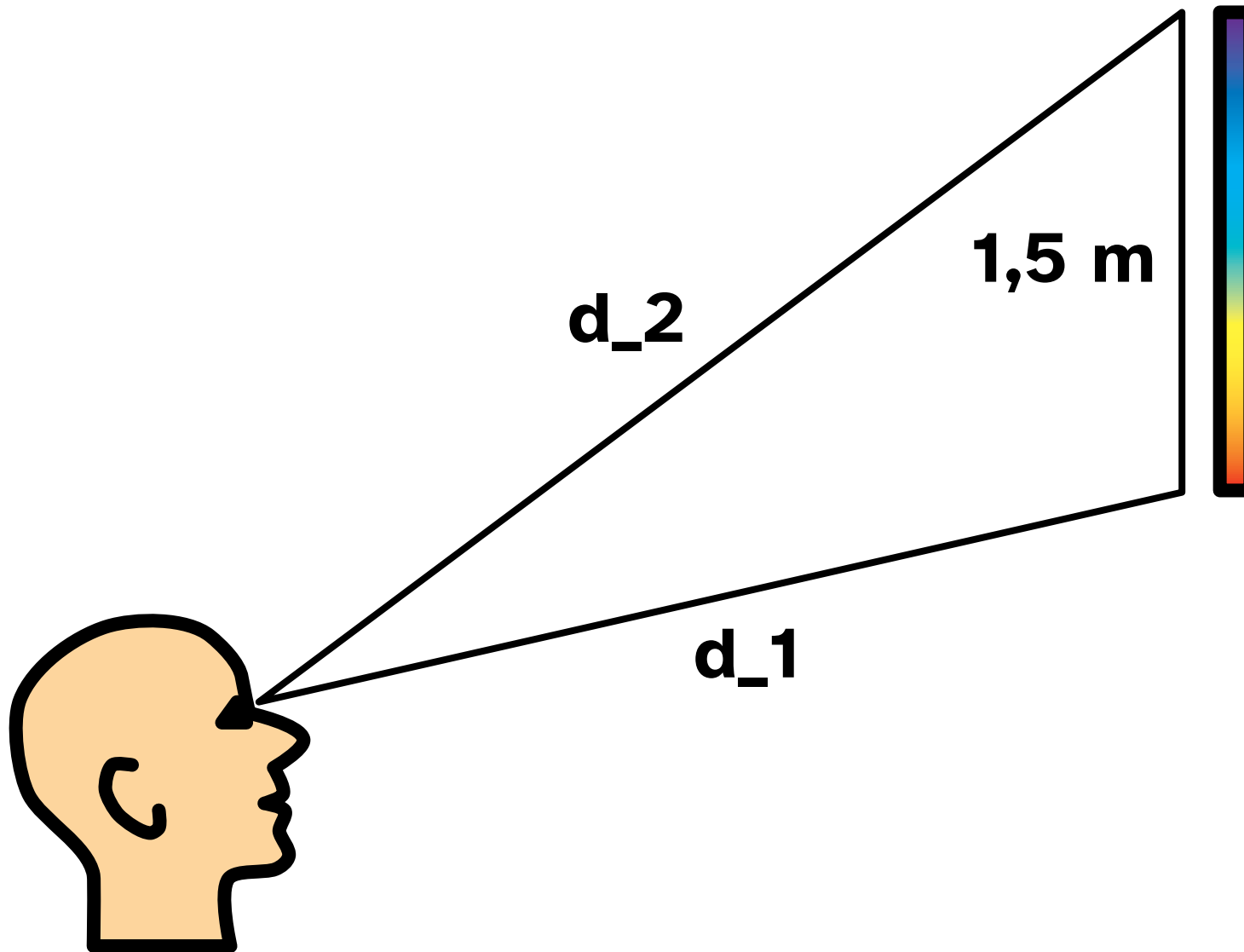
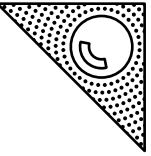

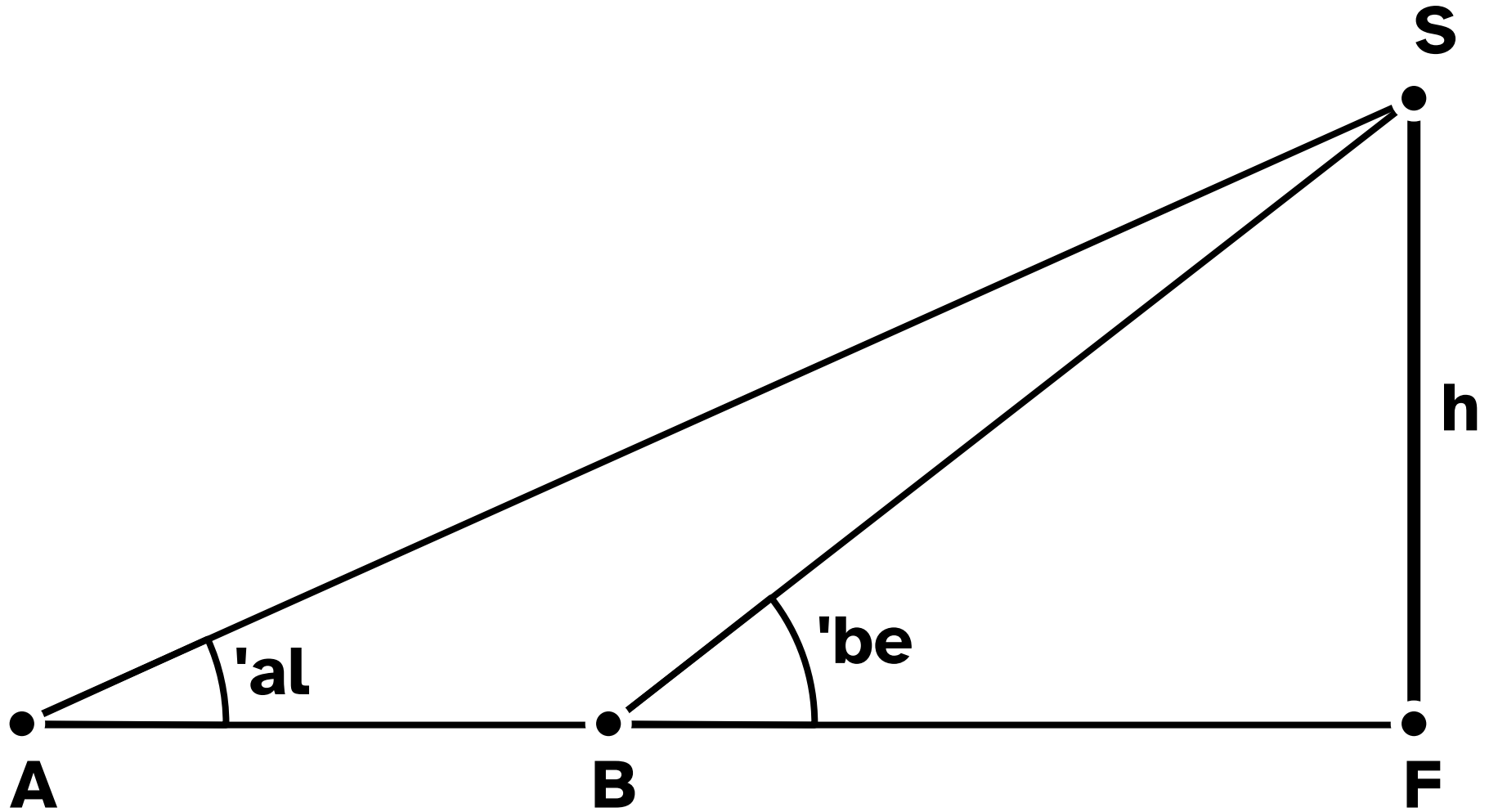
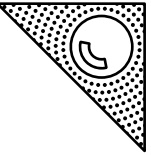

Ang.Mat. HAK2

S.121 5.87

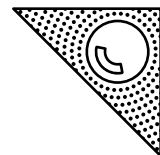

1 min



400 m

'be

'al

Turm

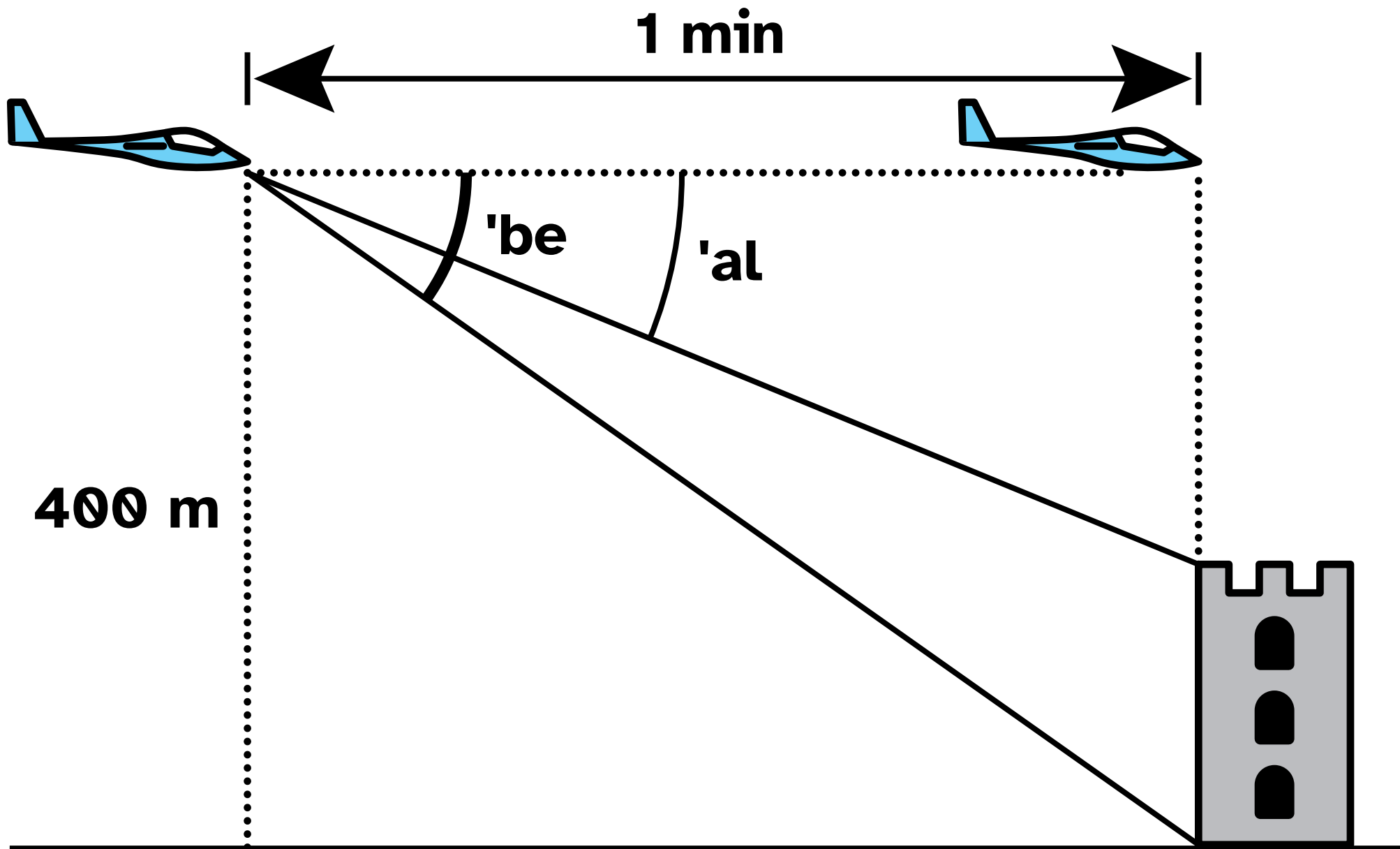

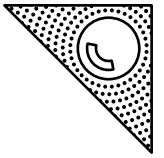

5.6 Winkelfunktionen - Maßsysteme

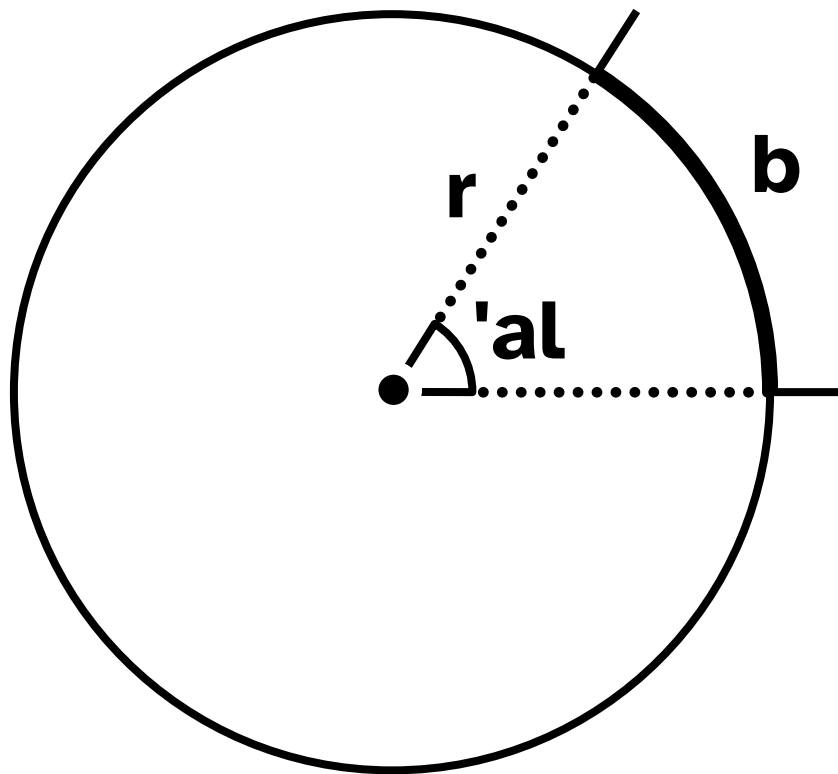

Beispiel:

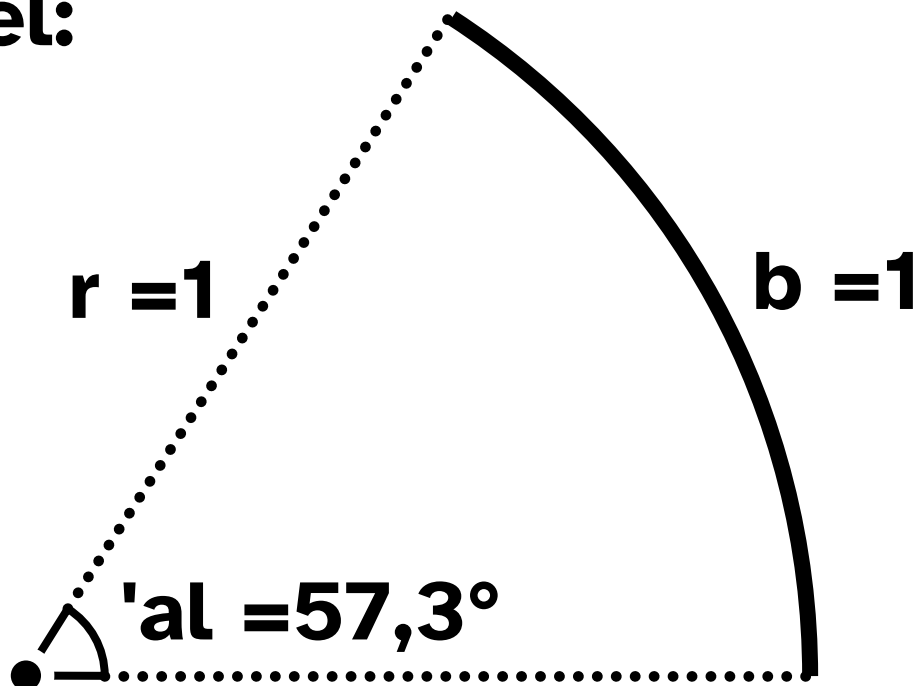

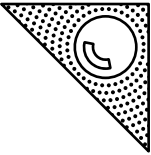

Besondere Winkel im Grad- und Bogenmaß 1/3

Ganze Drehung
Gradmaß: 360°
Bogenmaß: 2π

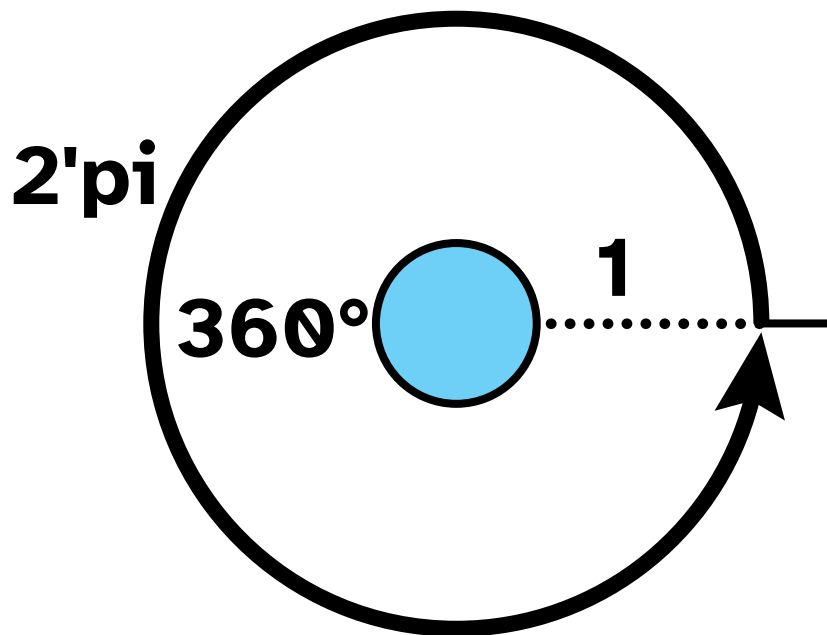

Halbe Drehung
Gradmaß: 180°
Bogenmaß: π

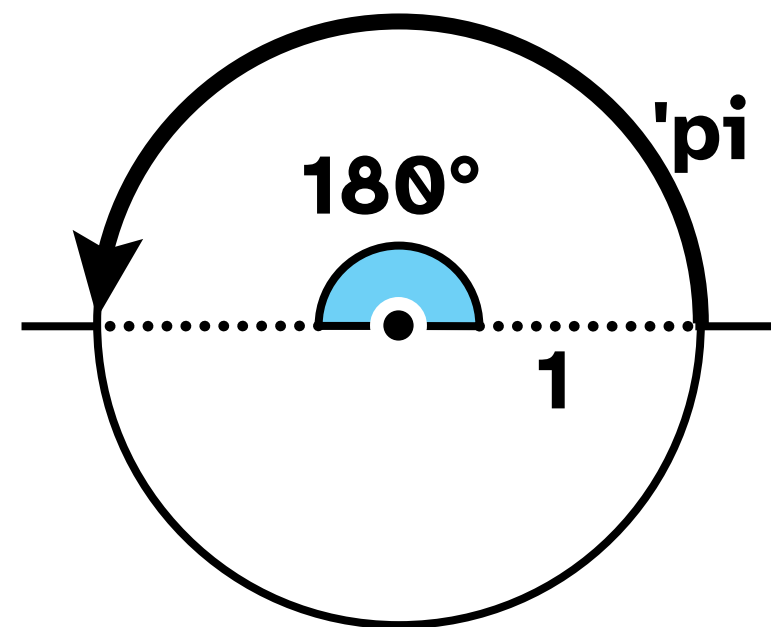

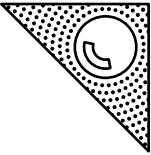

Besondere Winkel im Grad- und Bogenmaß 2/3

Vierteldrehung

Gradmaß: 90°

Bogenmaß: $\pi / 2$

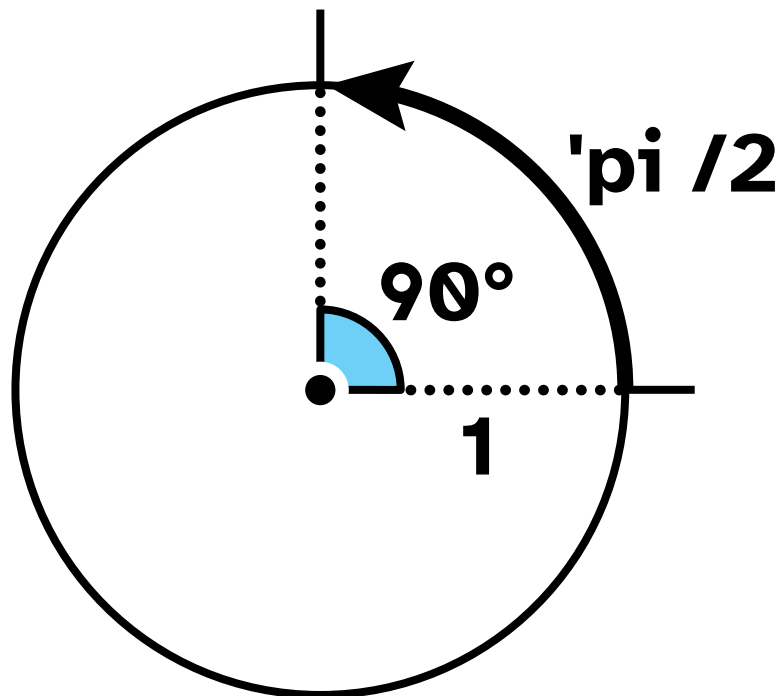

Achteldrehung

Gradmaß: 45°

Bogenmaß: $\pi / 4$

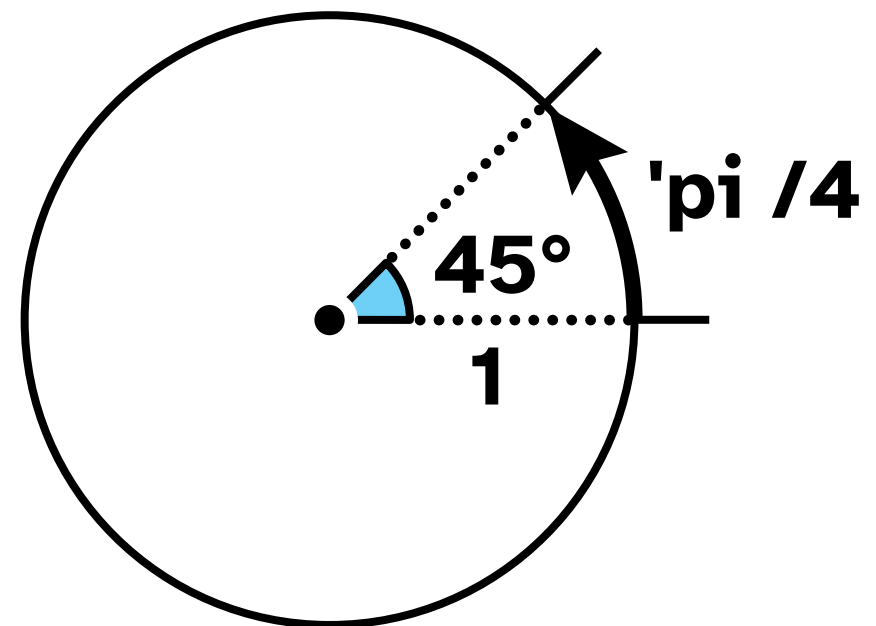

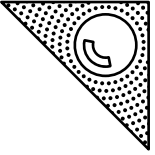

Besondere Winkel im Grad- und Bogenmaß 3/3

Zwölfteldrehung

Gradmaß: 30°

Bogenmaß: $\pi / 6$

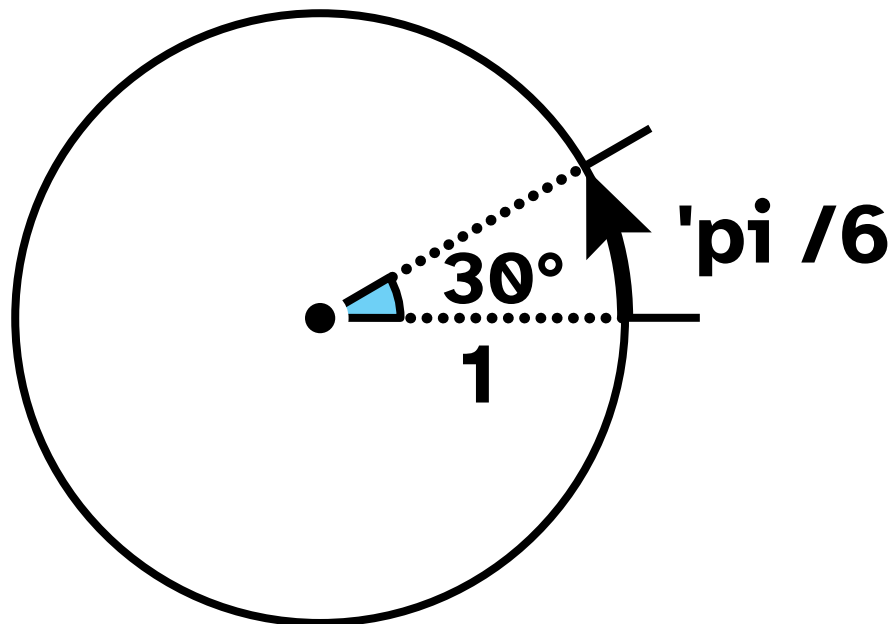

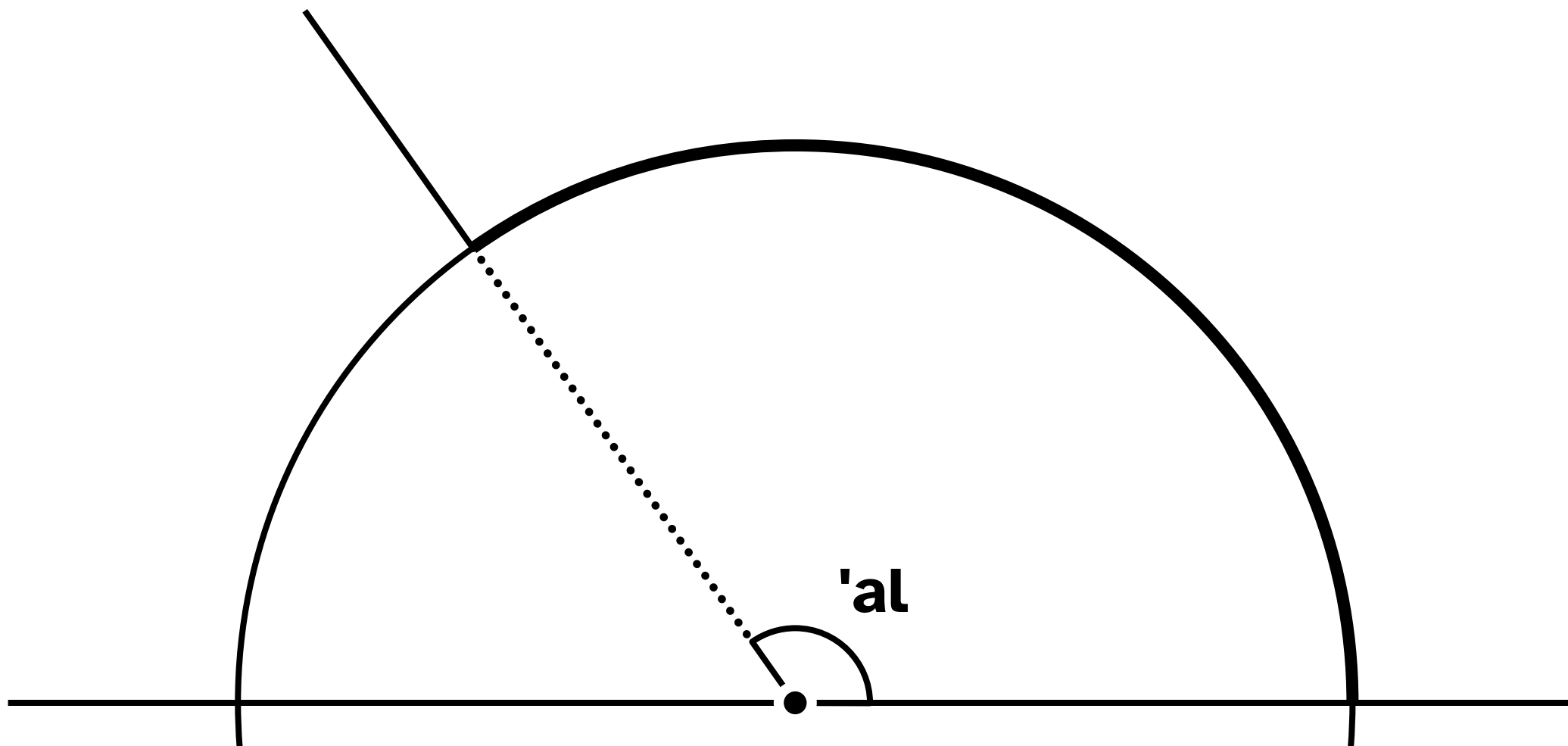
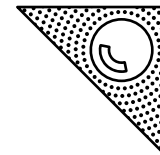

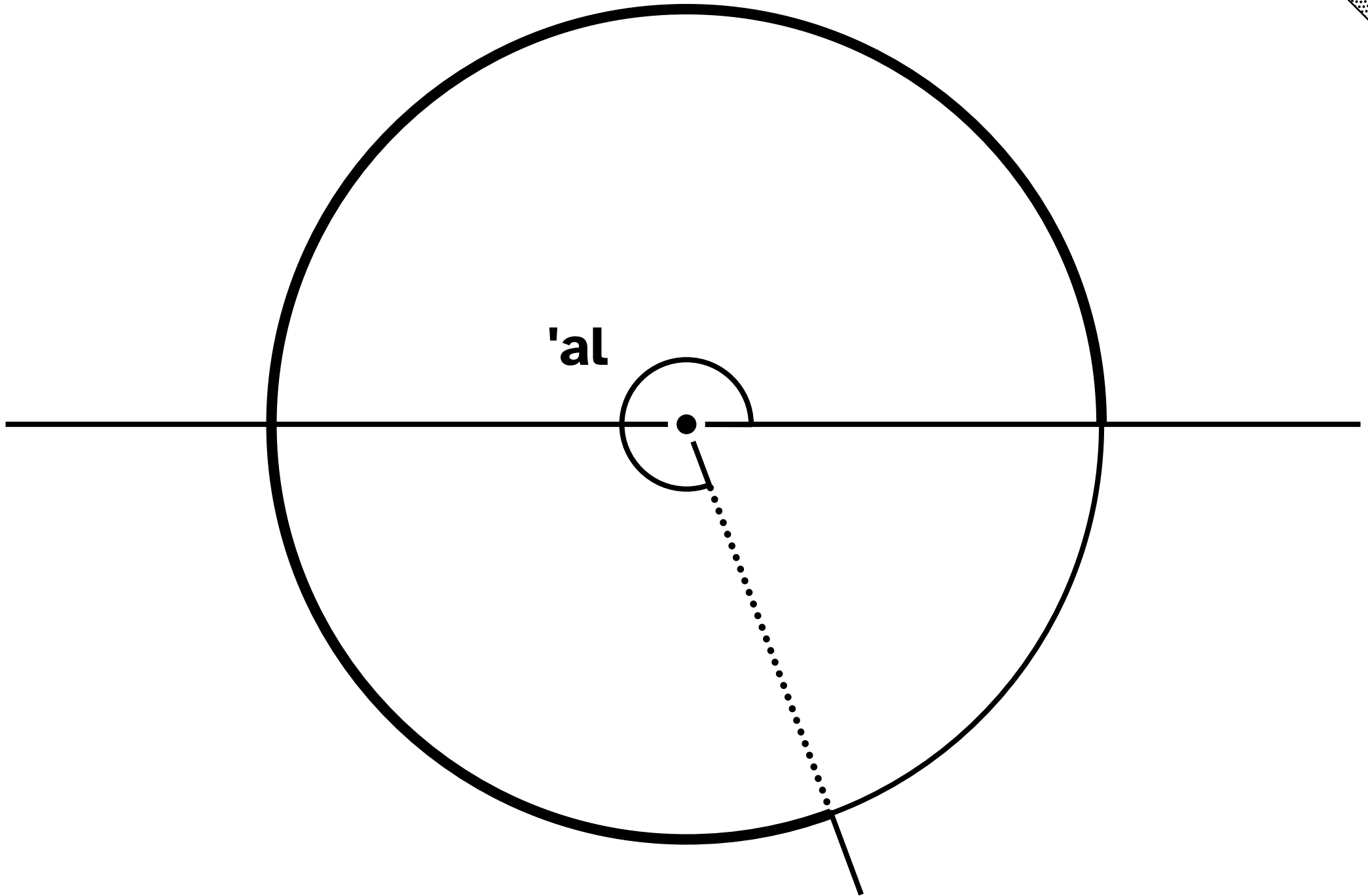
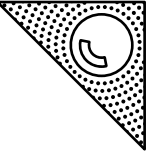

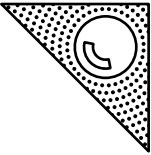

Graphen der Winkelfunktionen und Periodizität

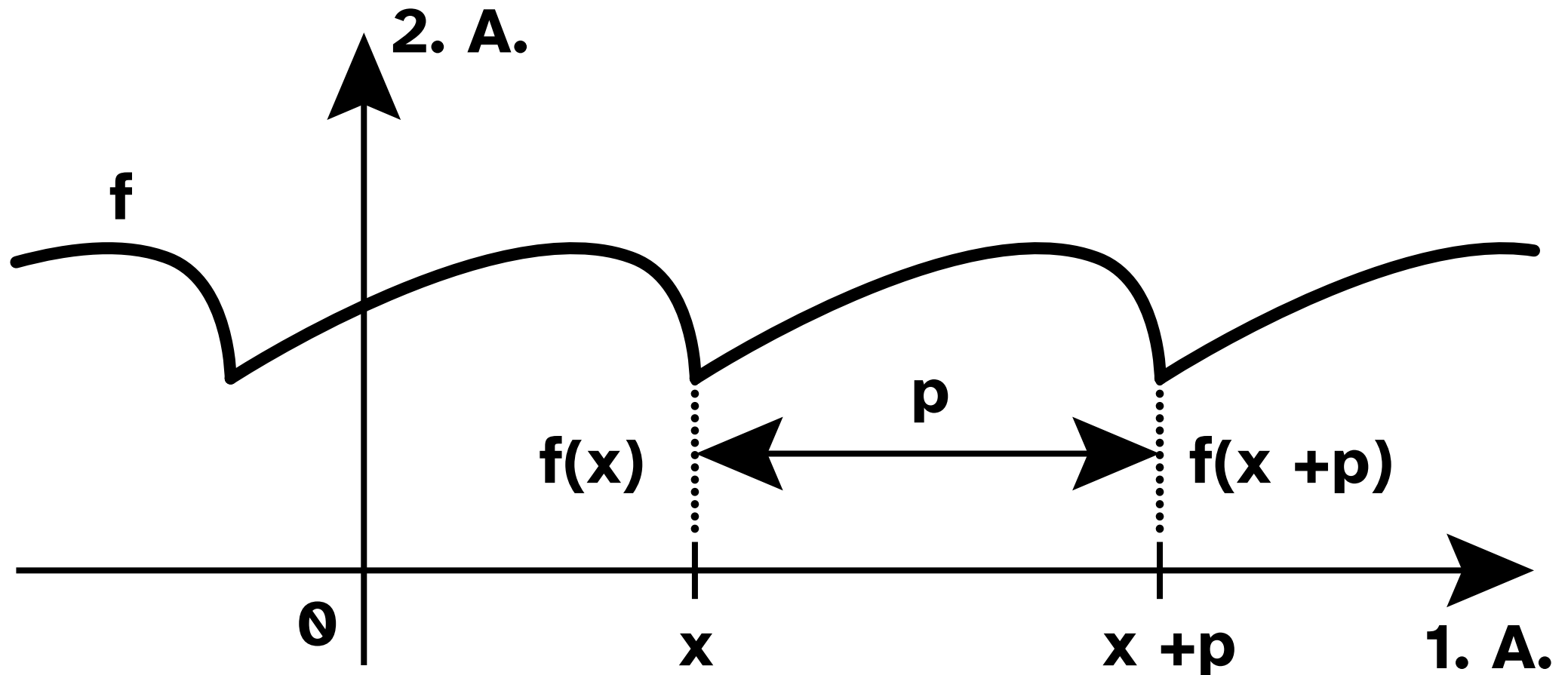

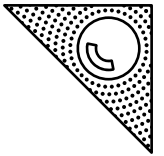

Sinusfunktion: $f(x) = \sin(x)$

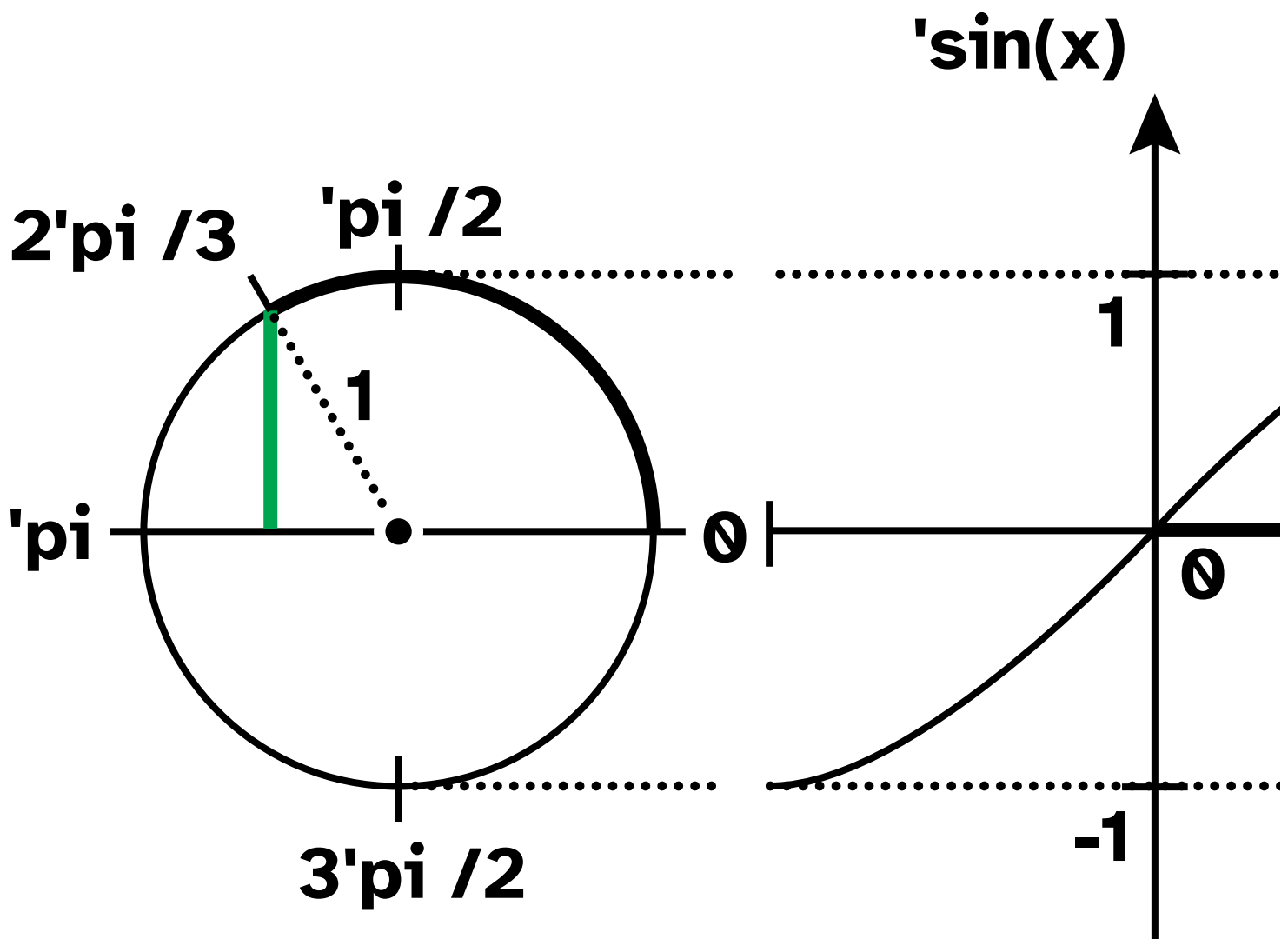

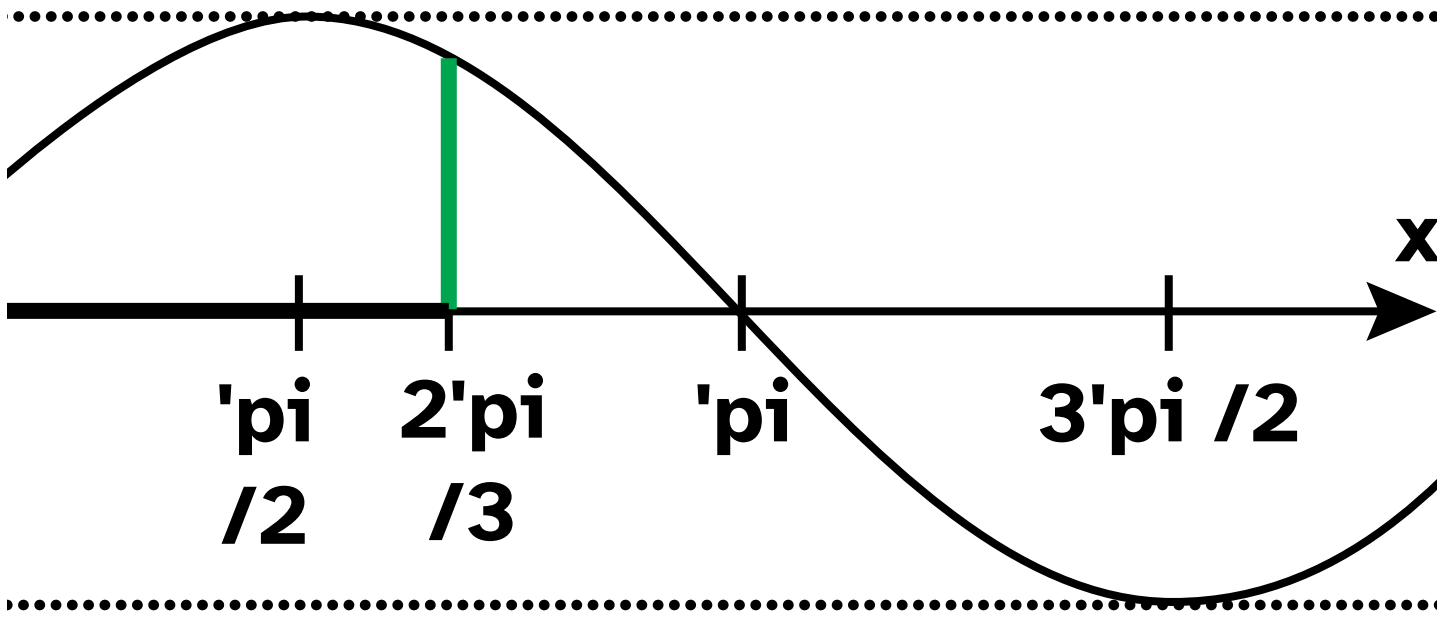

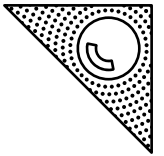

Cosinusfunktion: $f(x) = \cos(x)$

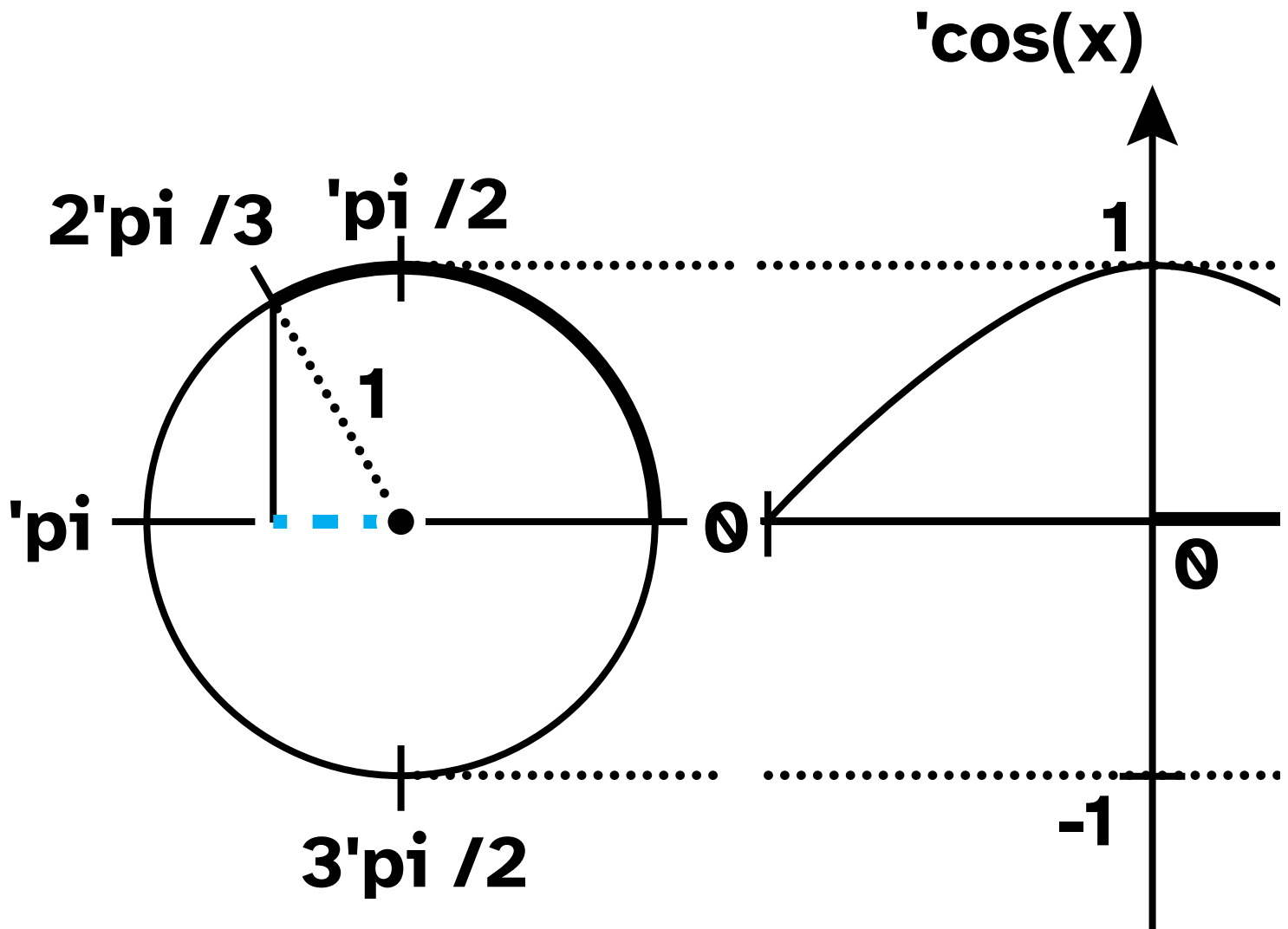

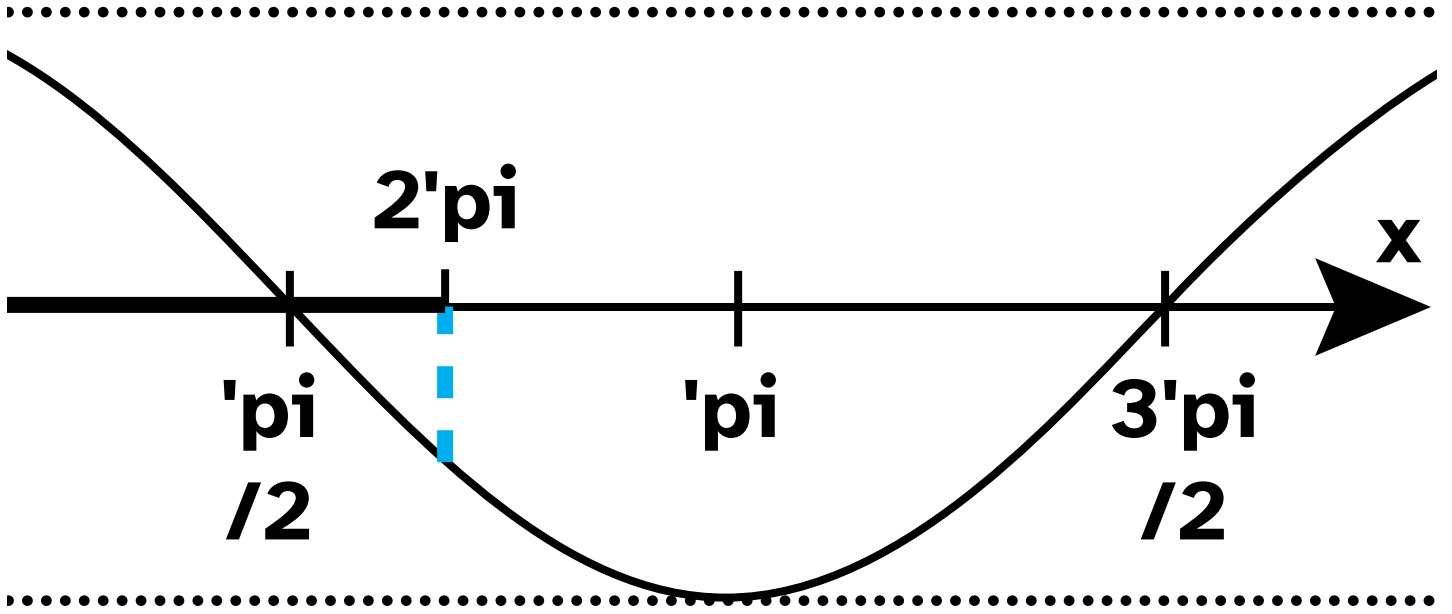

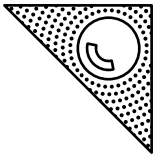

Tangensfunktion: $f(x) = \tan(x)$

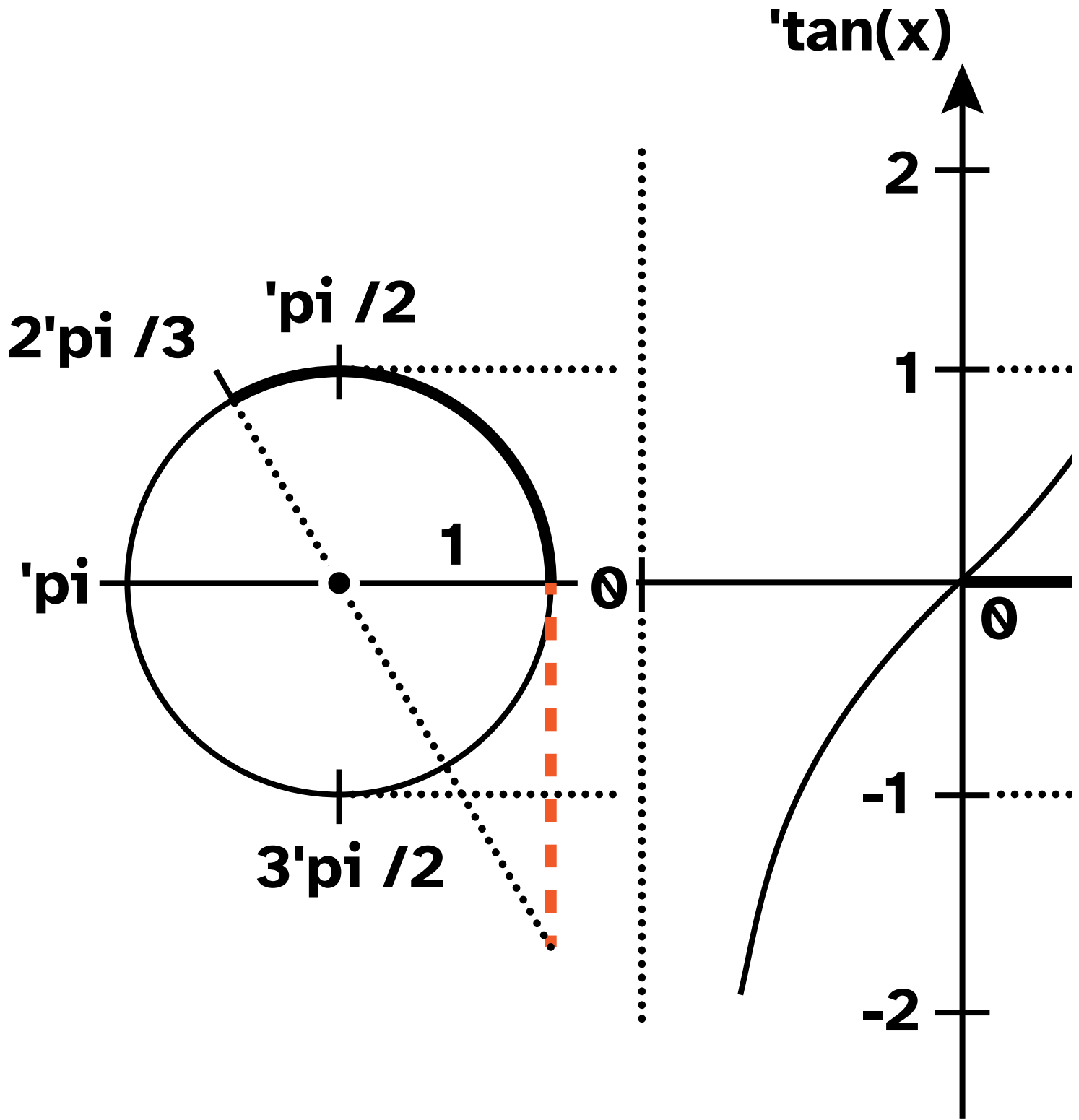

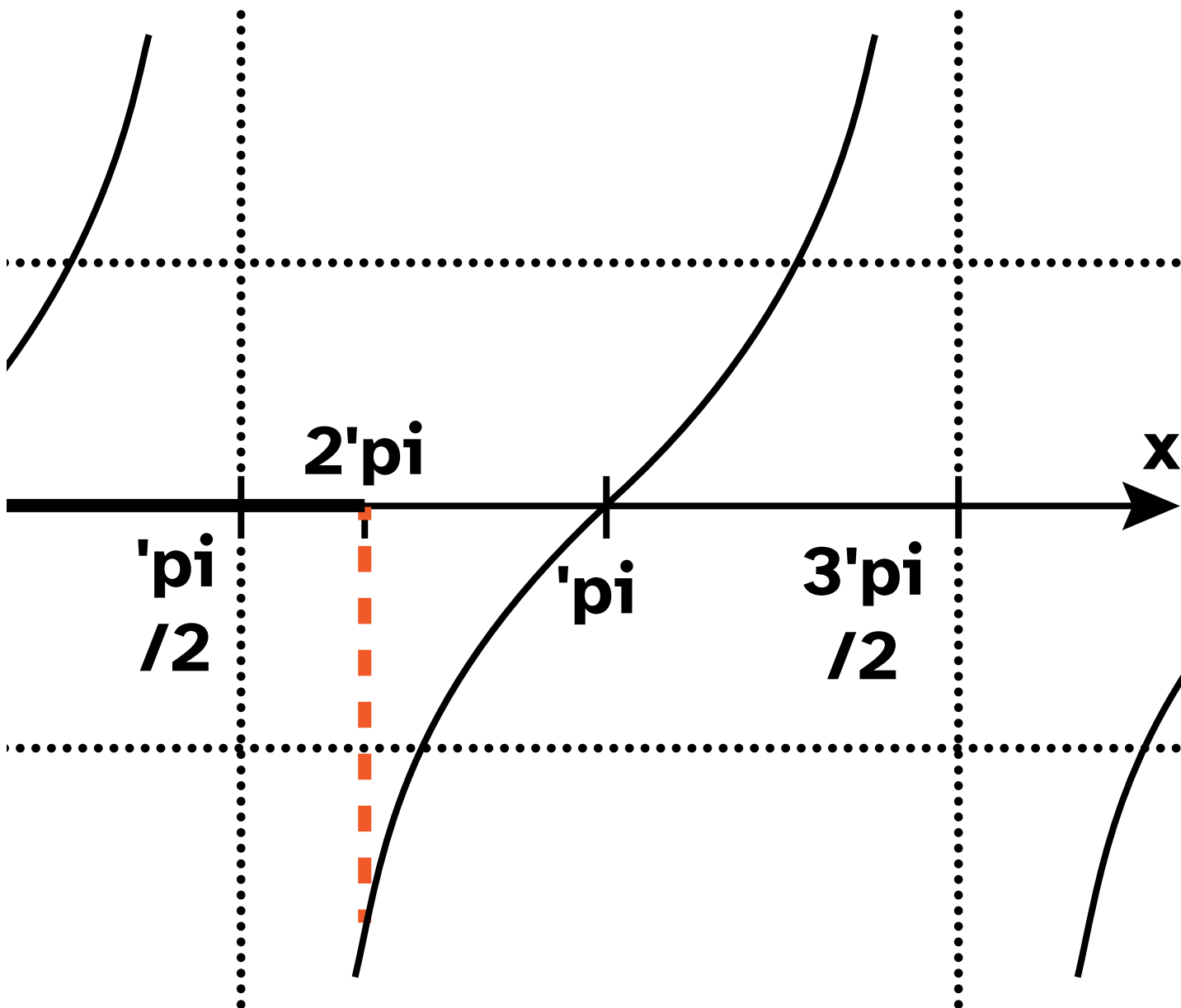

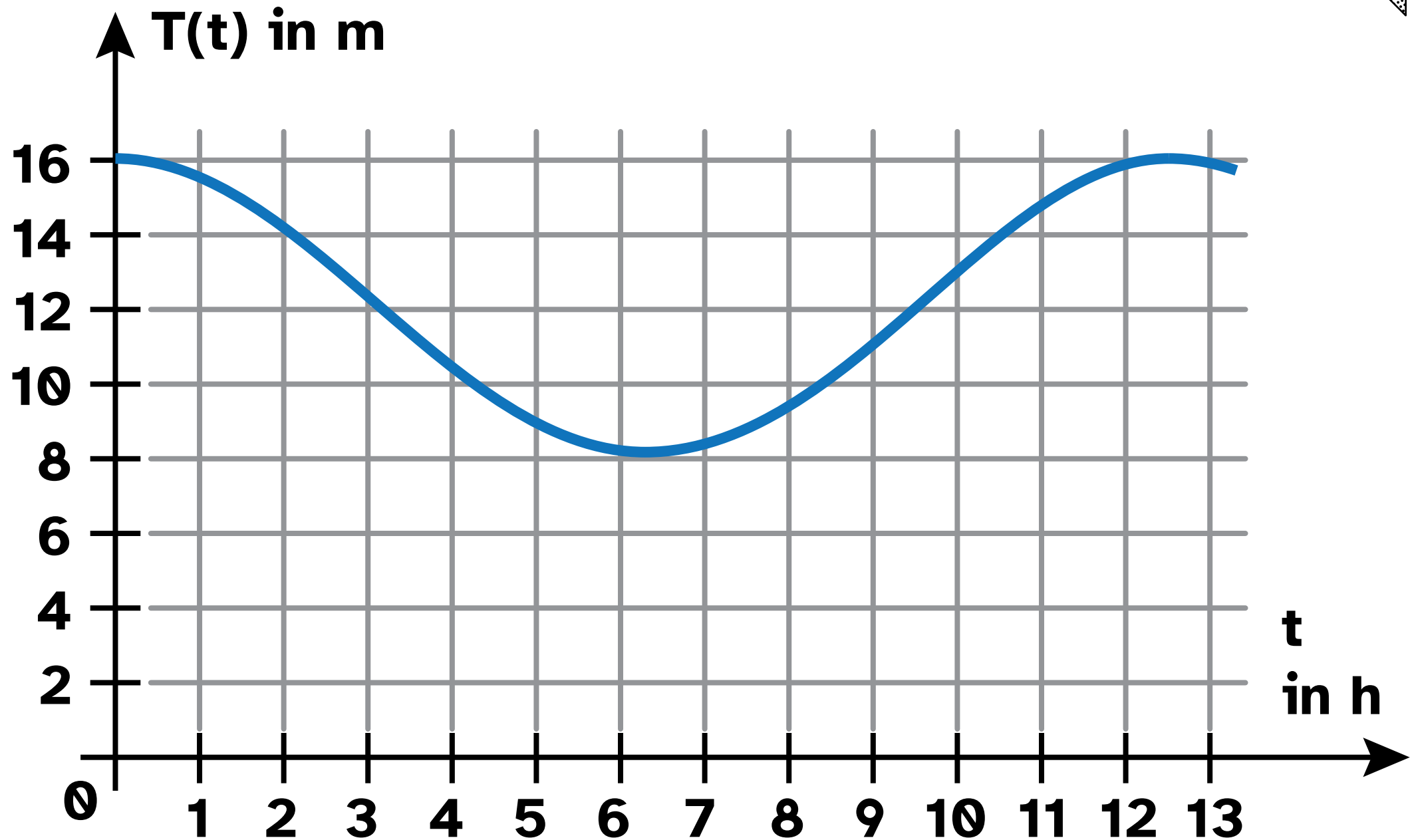
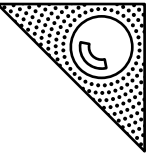

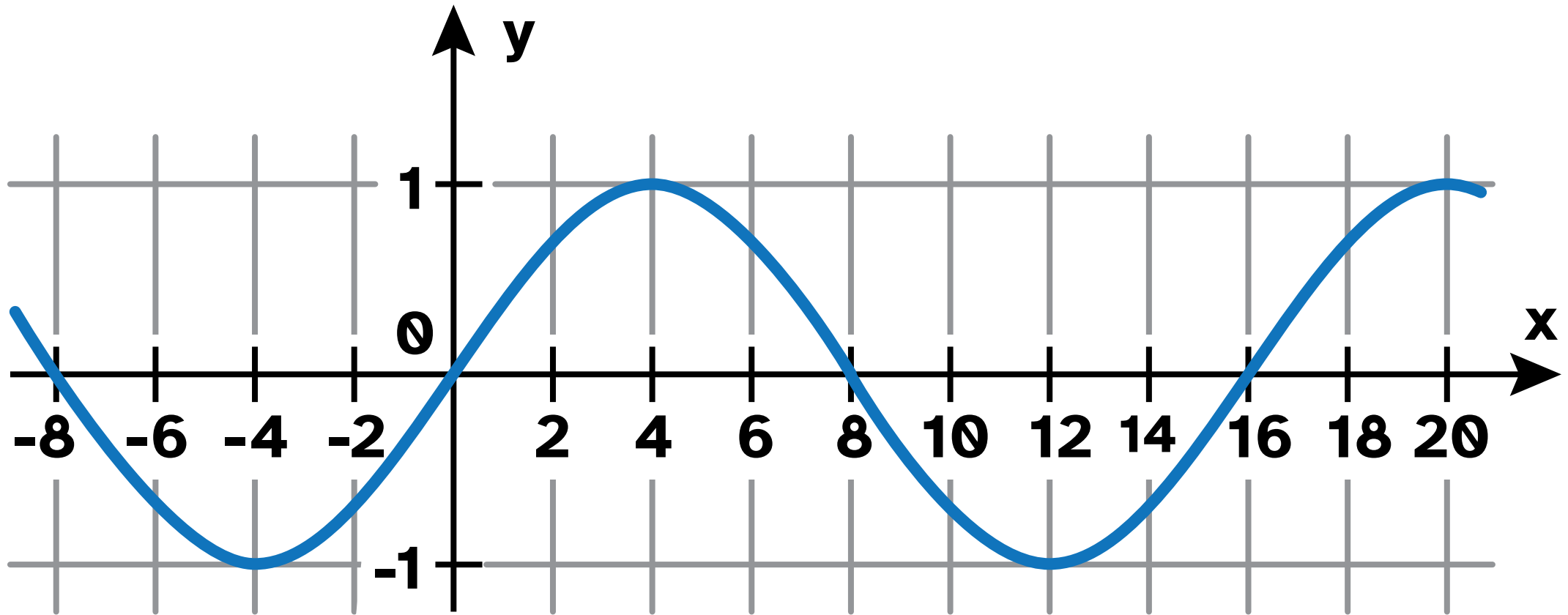
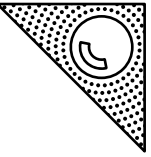

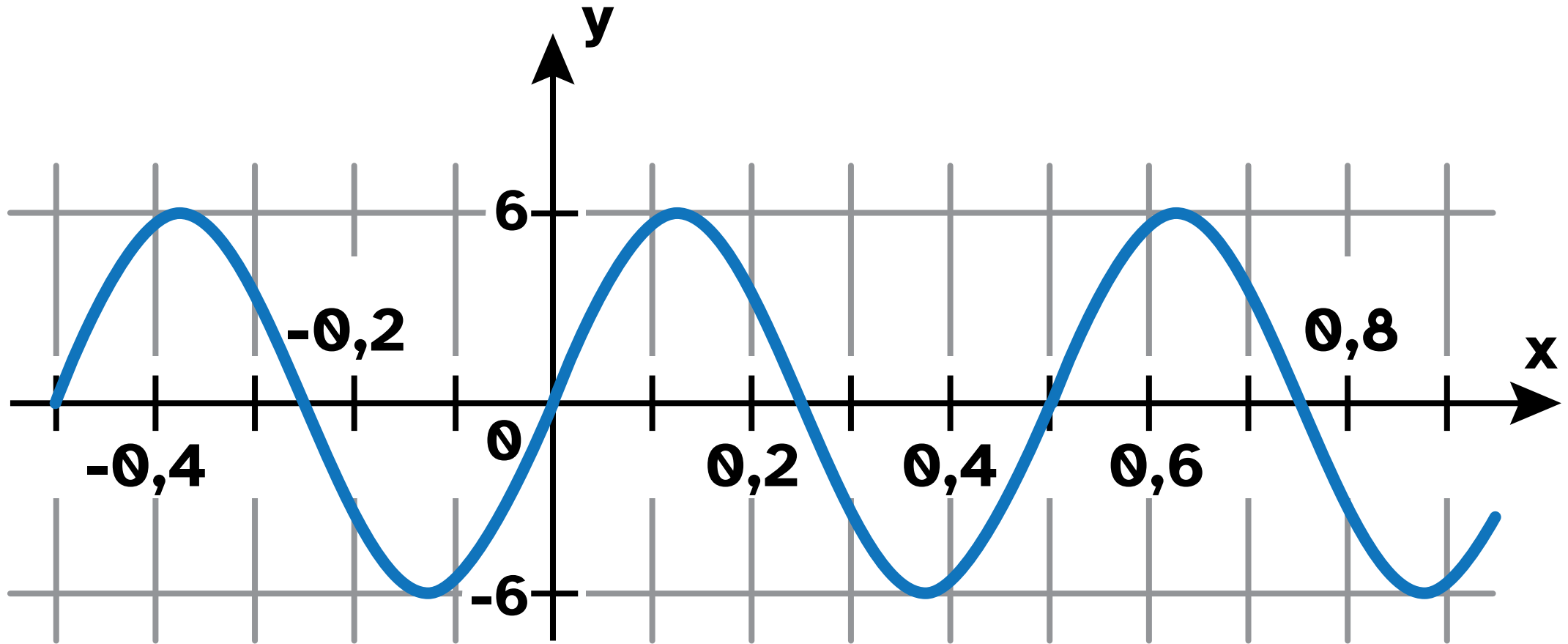
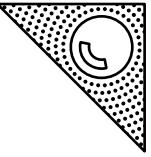

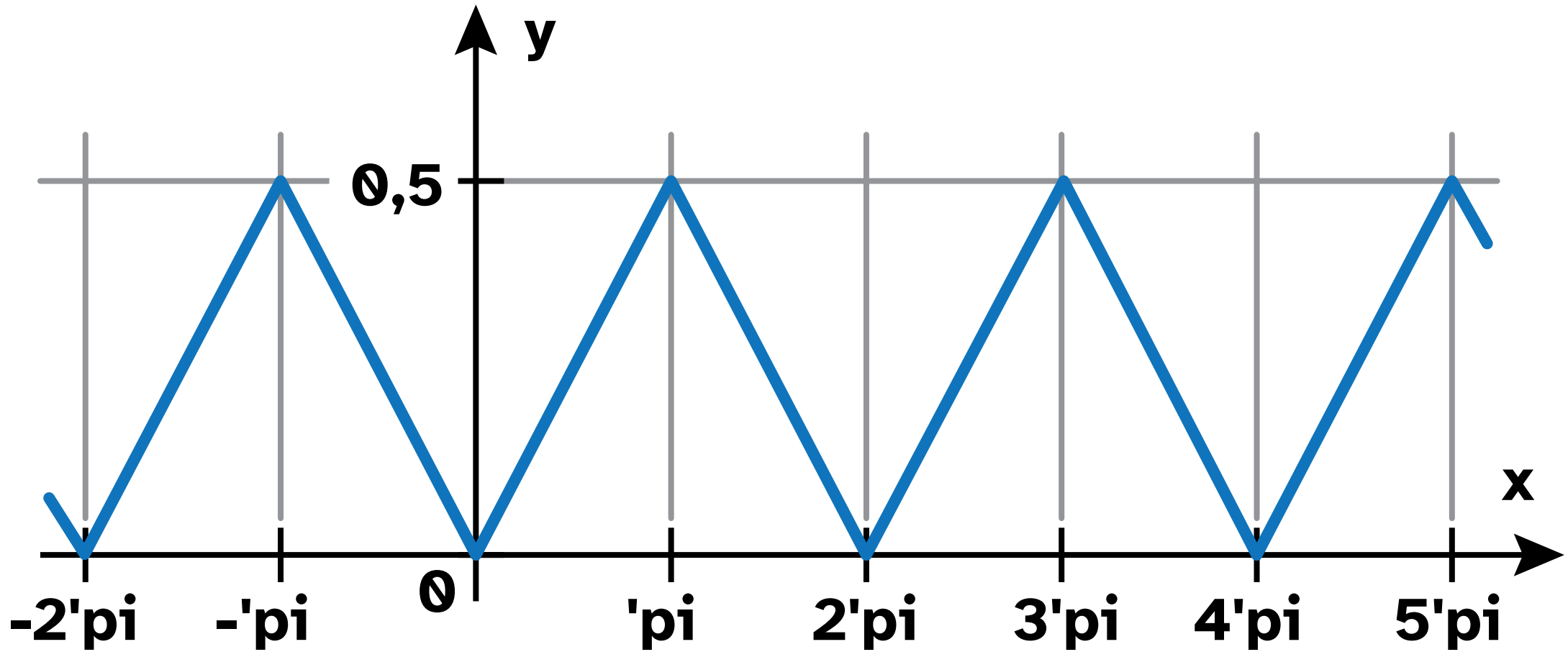
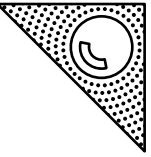

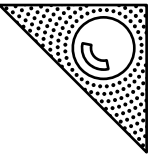

Amplitude

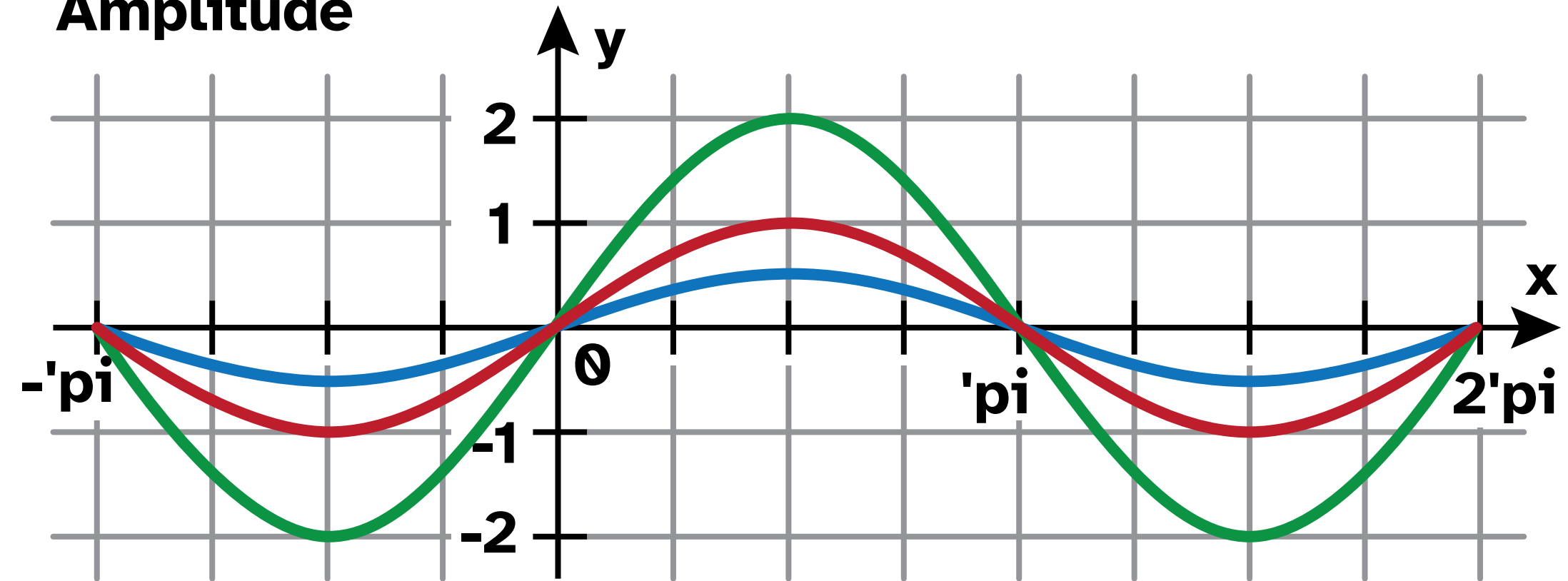

— $y = \sin(x), a = 1$

— $y = 2 \cdot \sin(x), a = 2$

— $y = 0,5 \cdot \sin(x), a = 1/2$

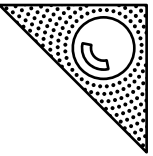

Frequenz

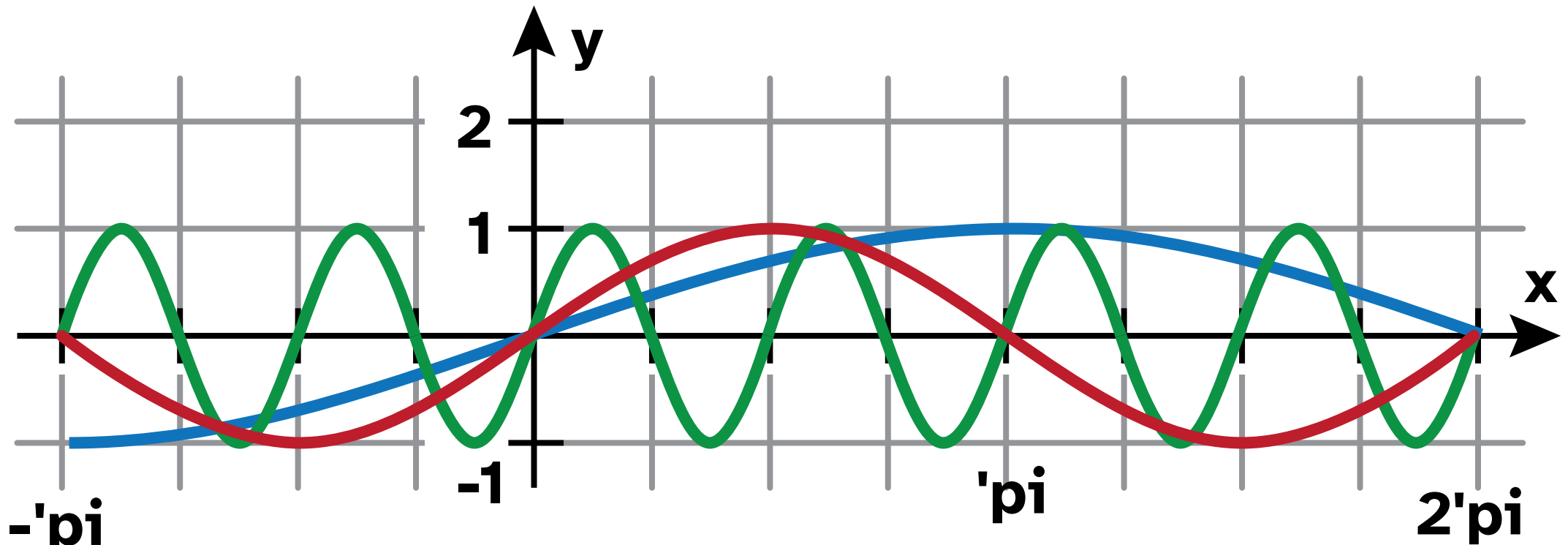

- $y = \sin(x), b = 1$
- $y = \sin(0,5x), b = 1/2$
- $y = \sin(4x), b = 4$

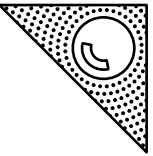

Phasenverschiebung

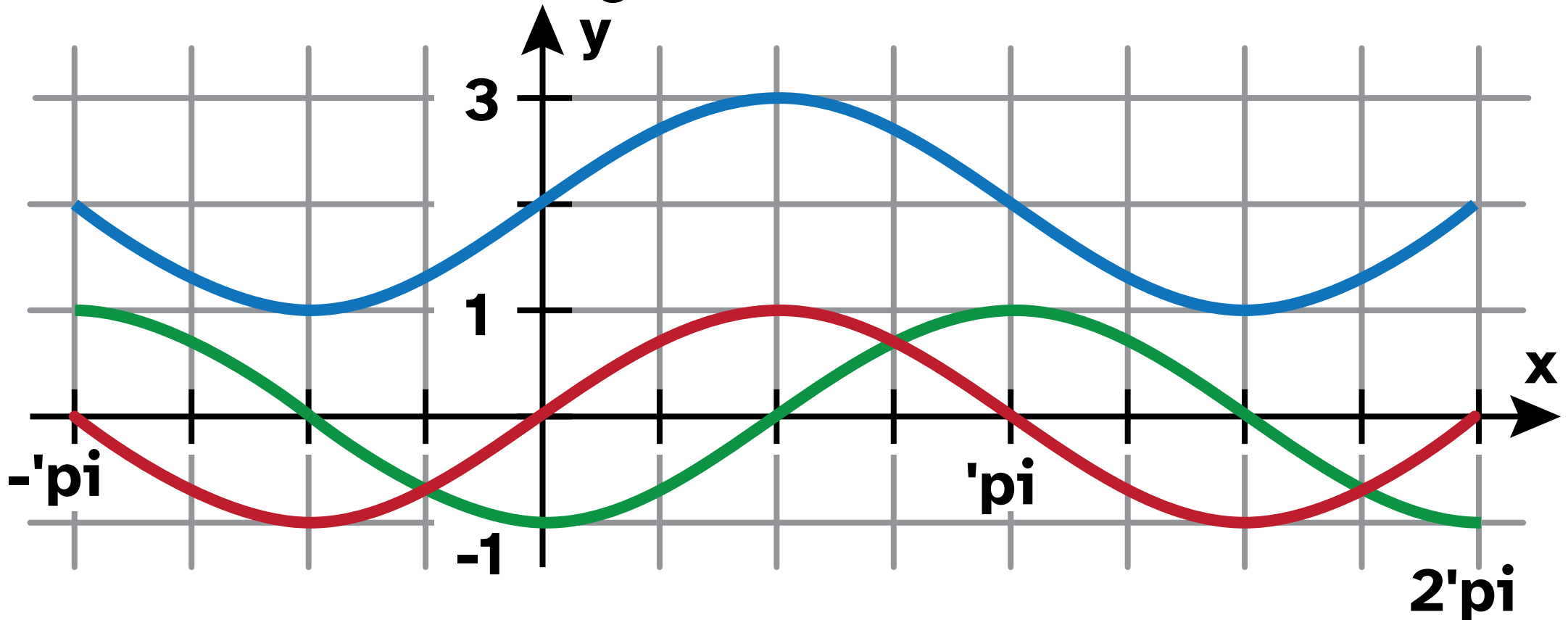

— $y = \sin(x), b = 1$

— $y = \sin(x) + 2, d = 2$

— $y = \sin(x - \pi/2), c = -\pi/2$

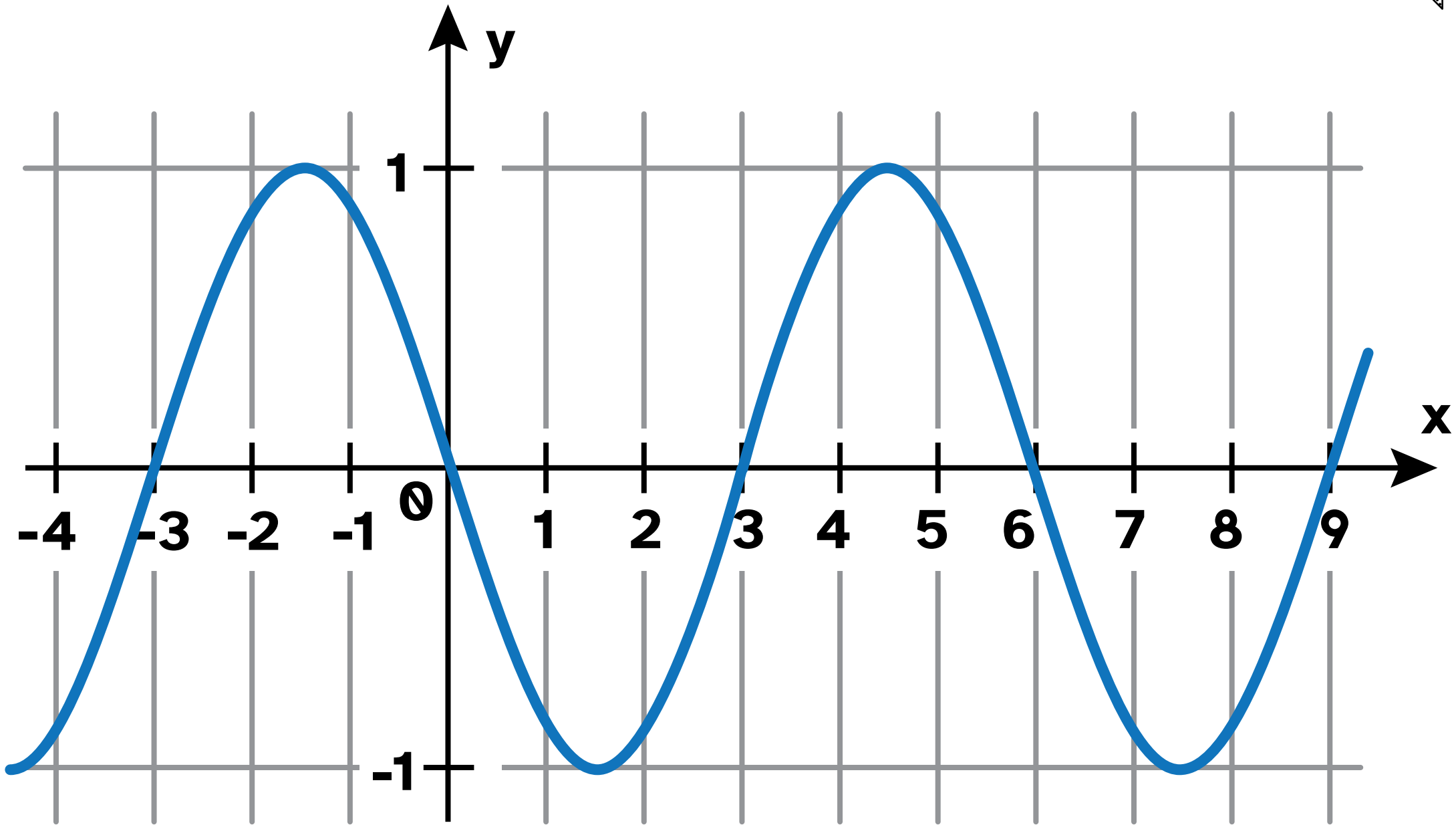
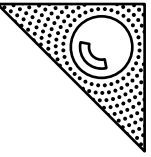

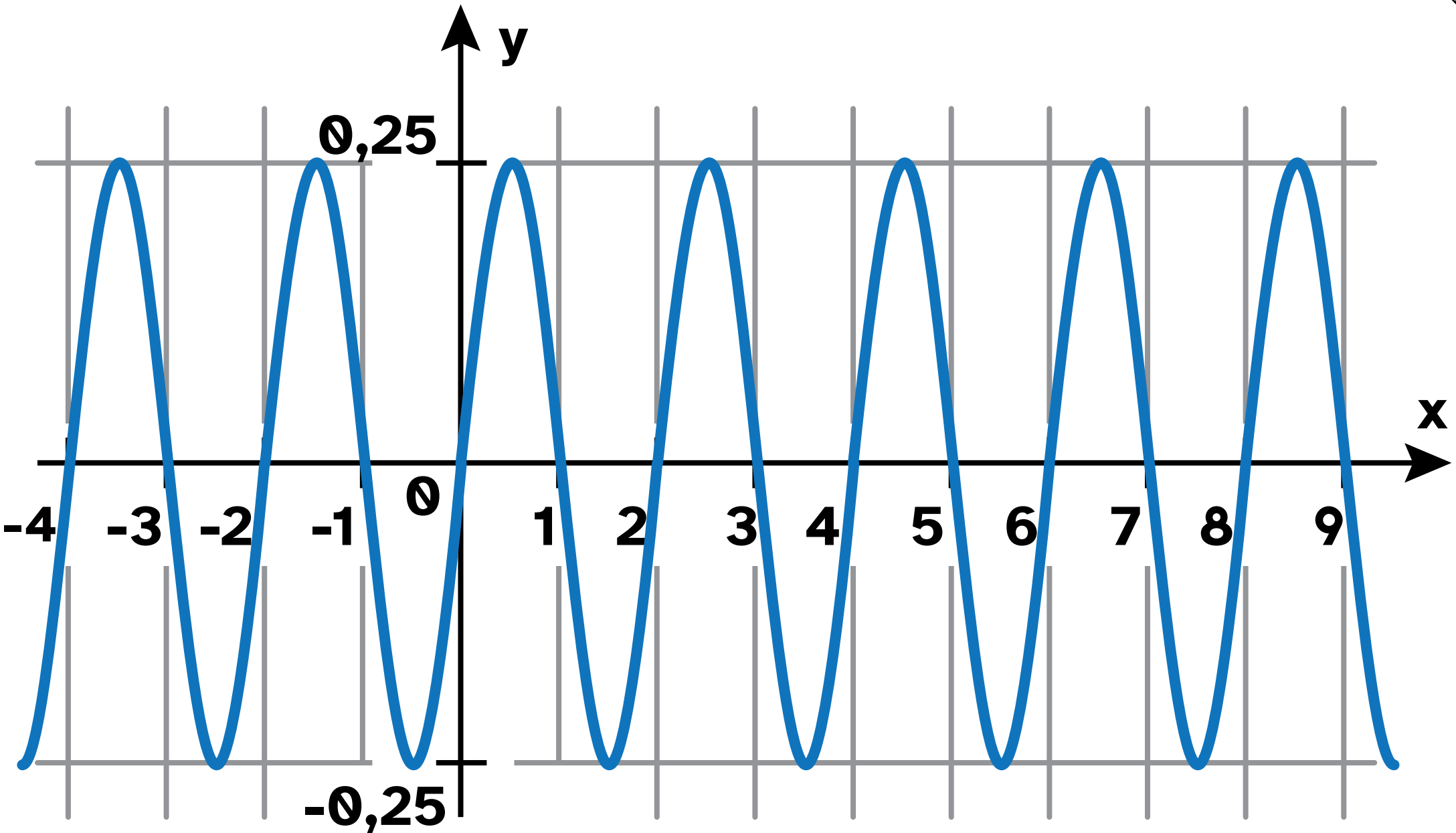
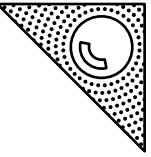

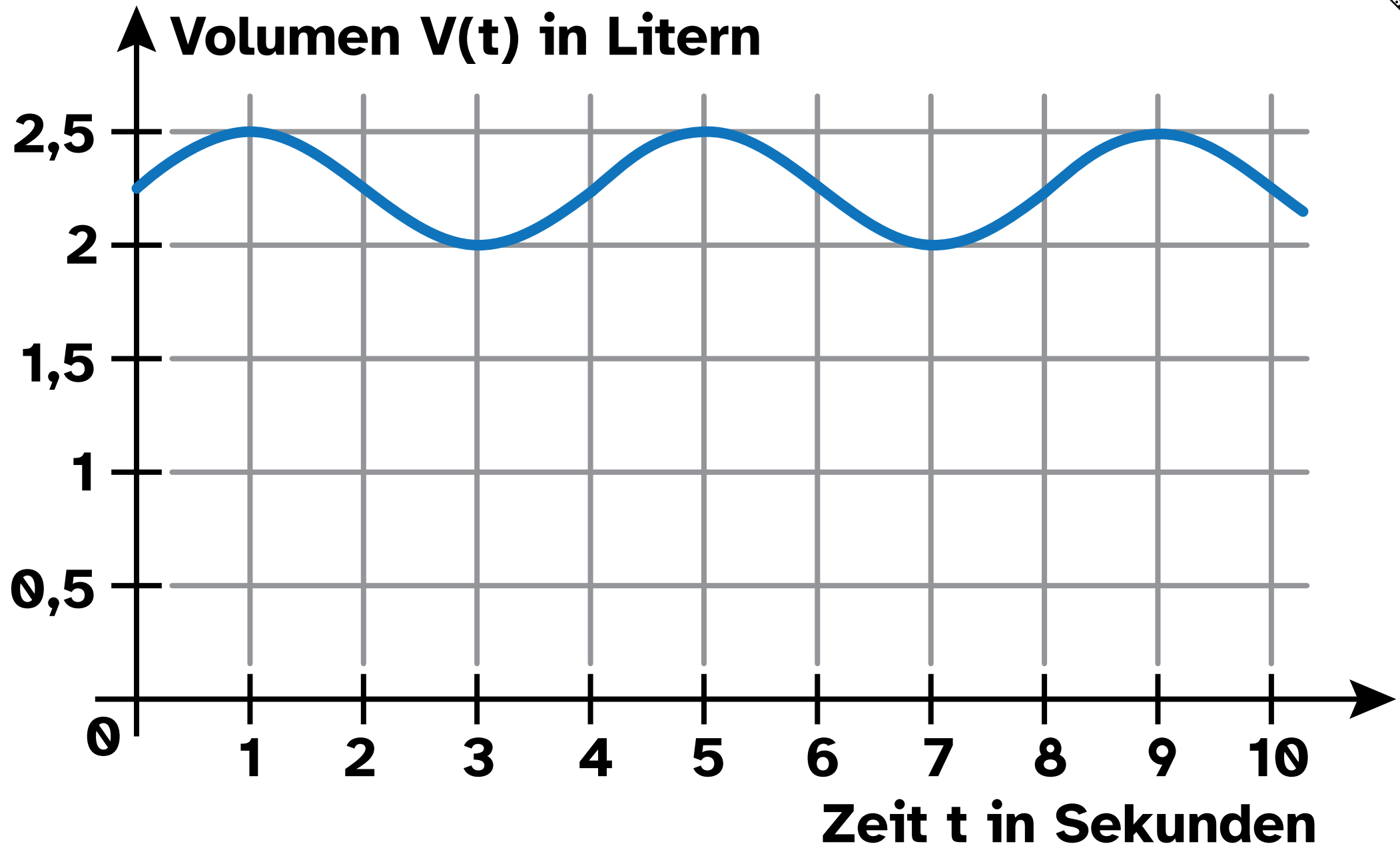
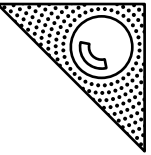

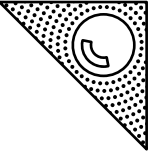

Sendermast

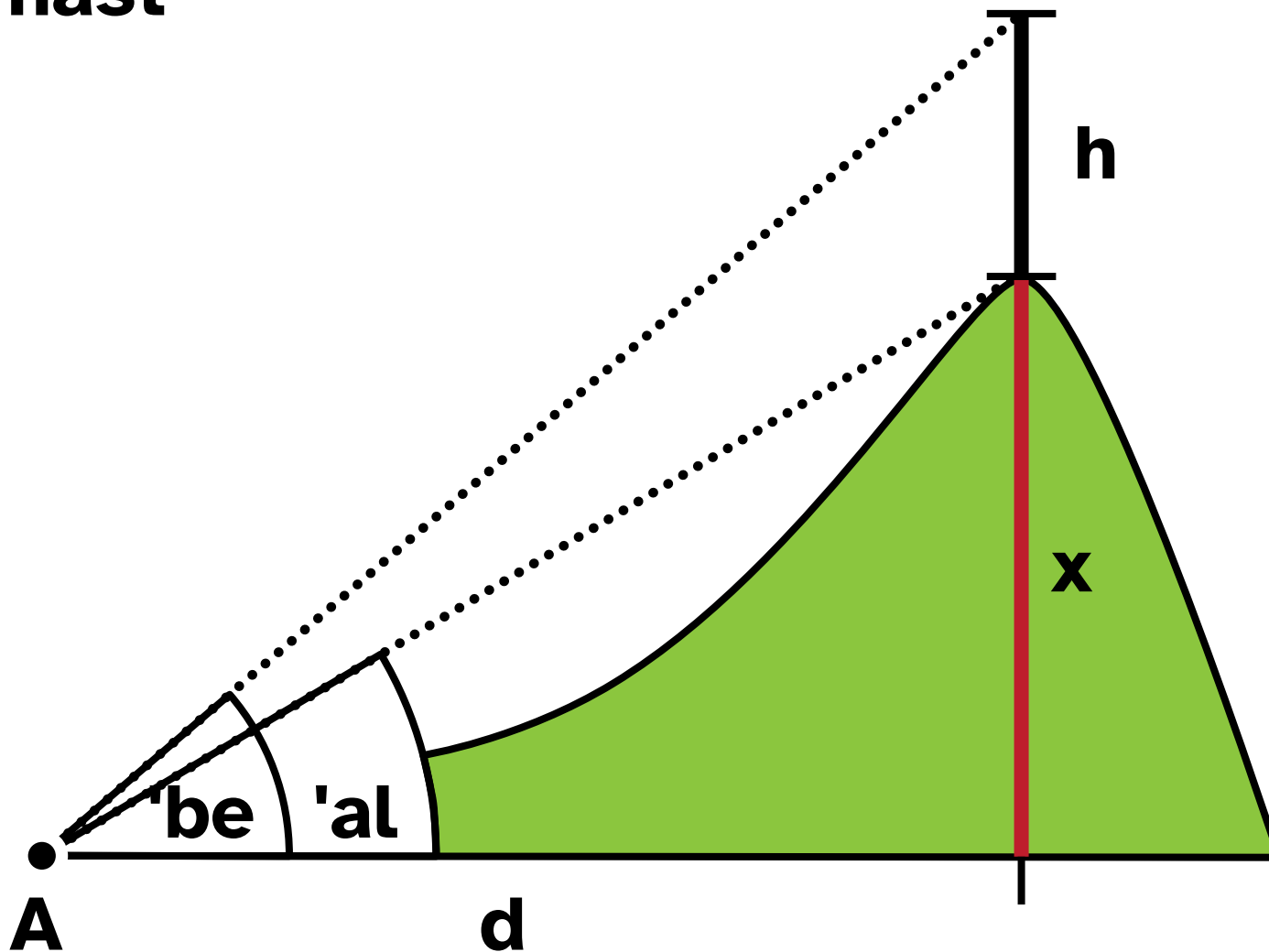

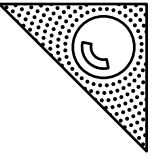

Kirchturm

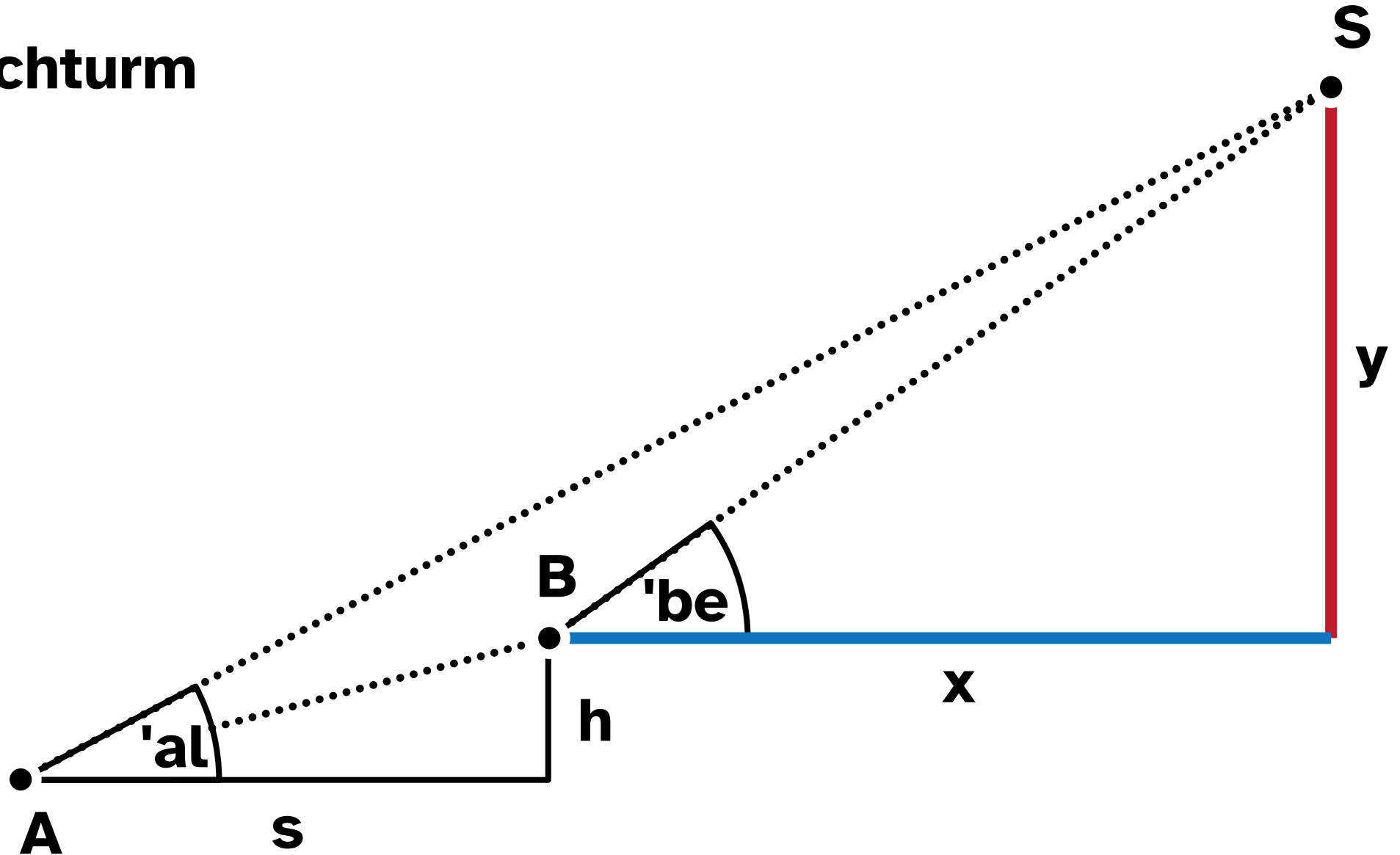

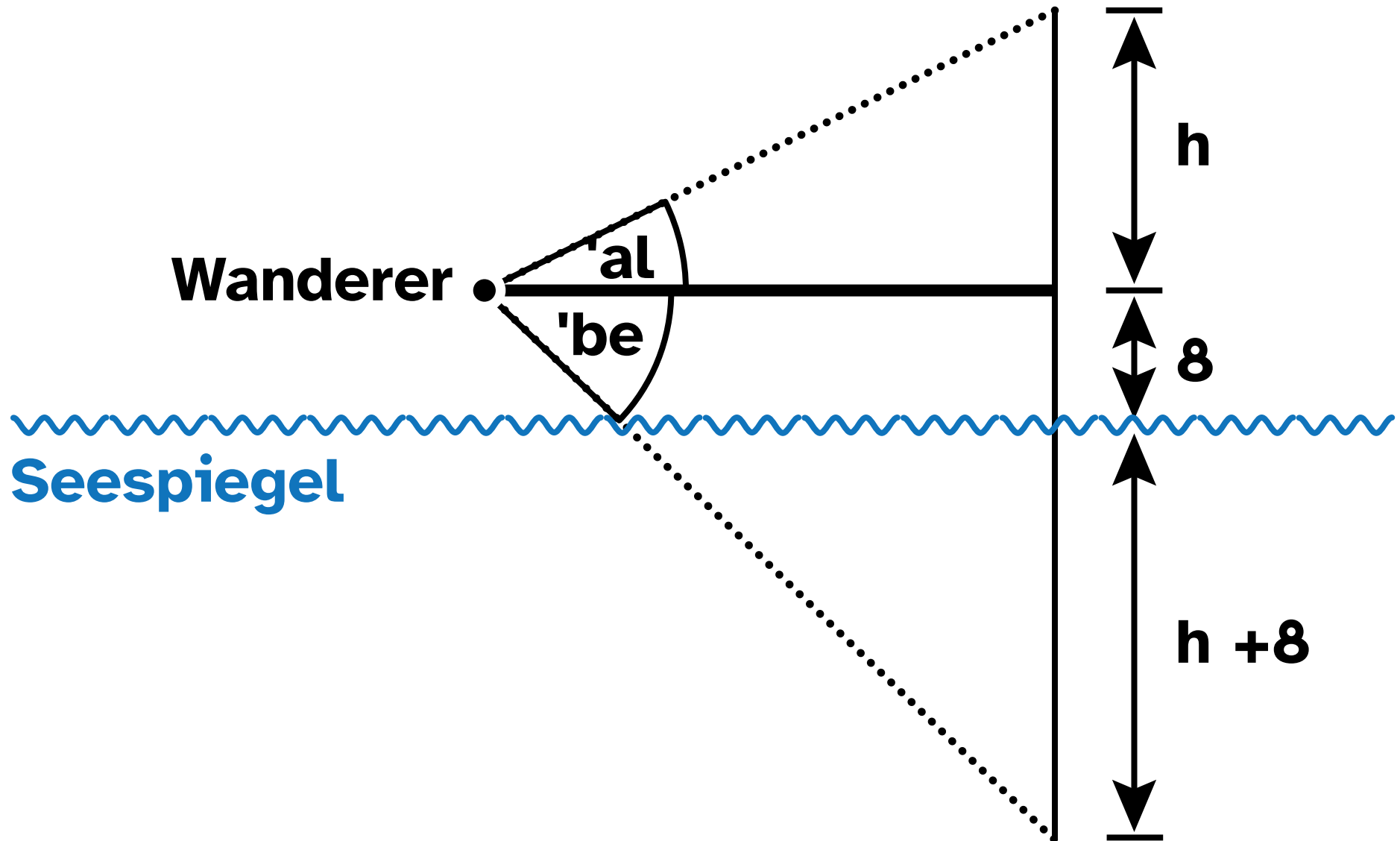
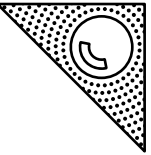

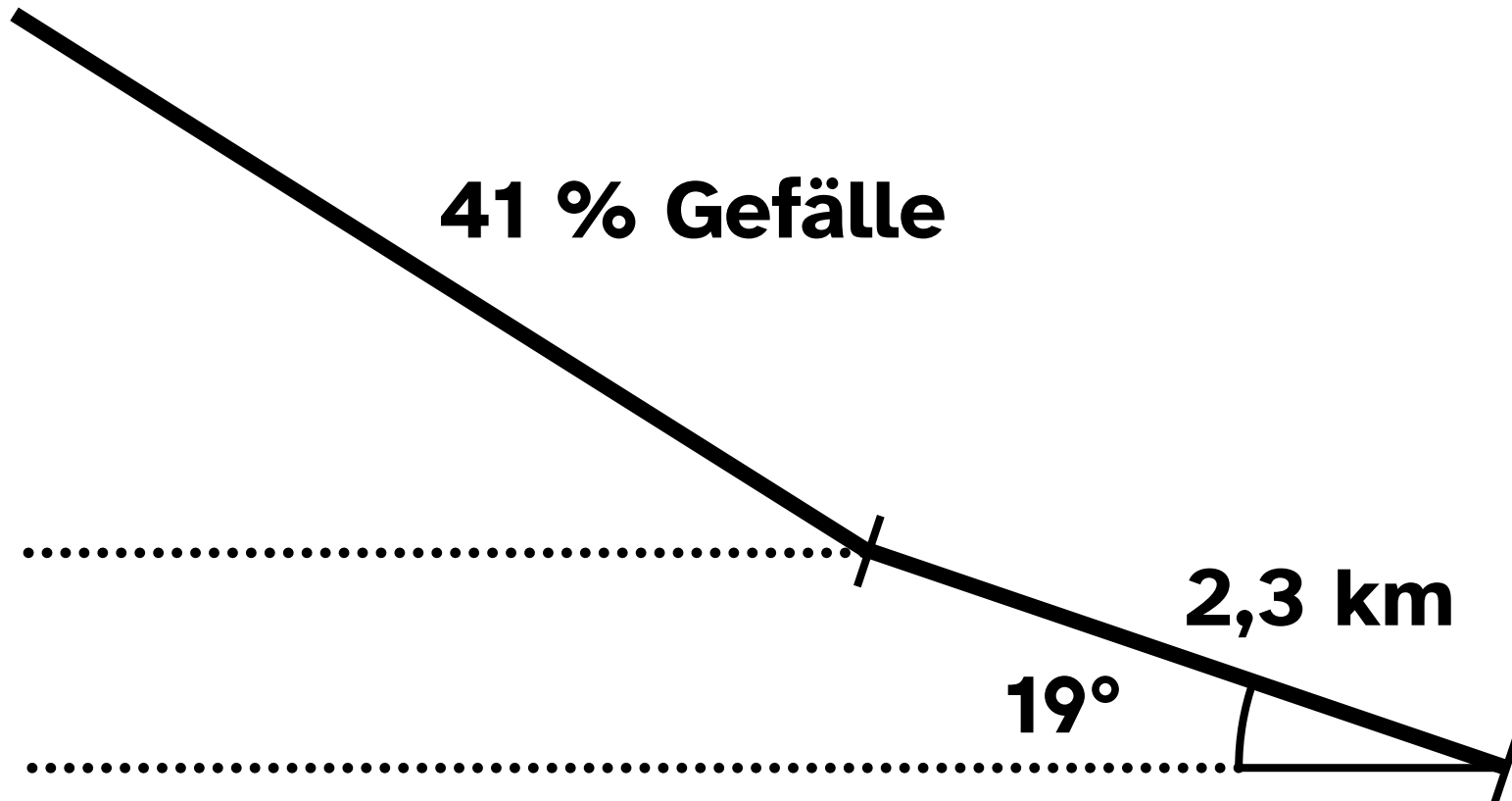
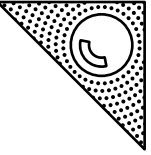

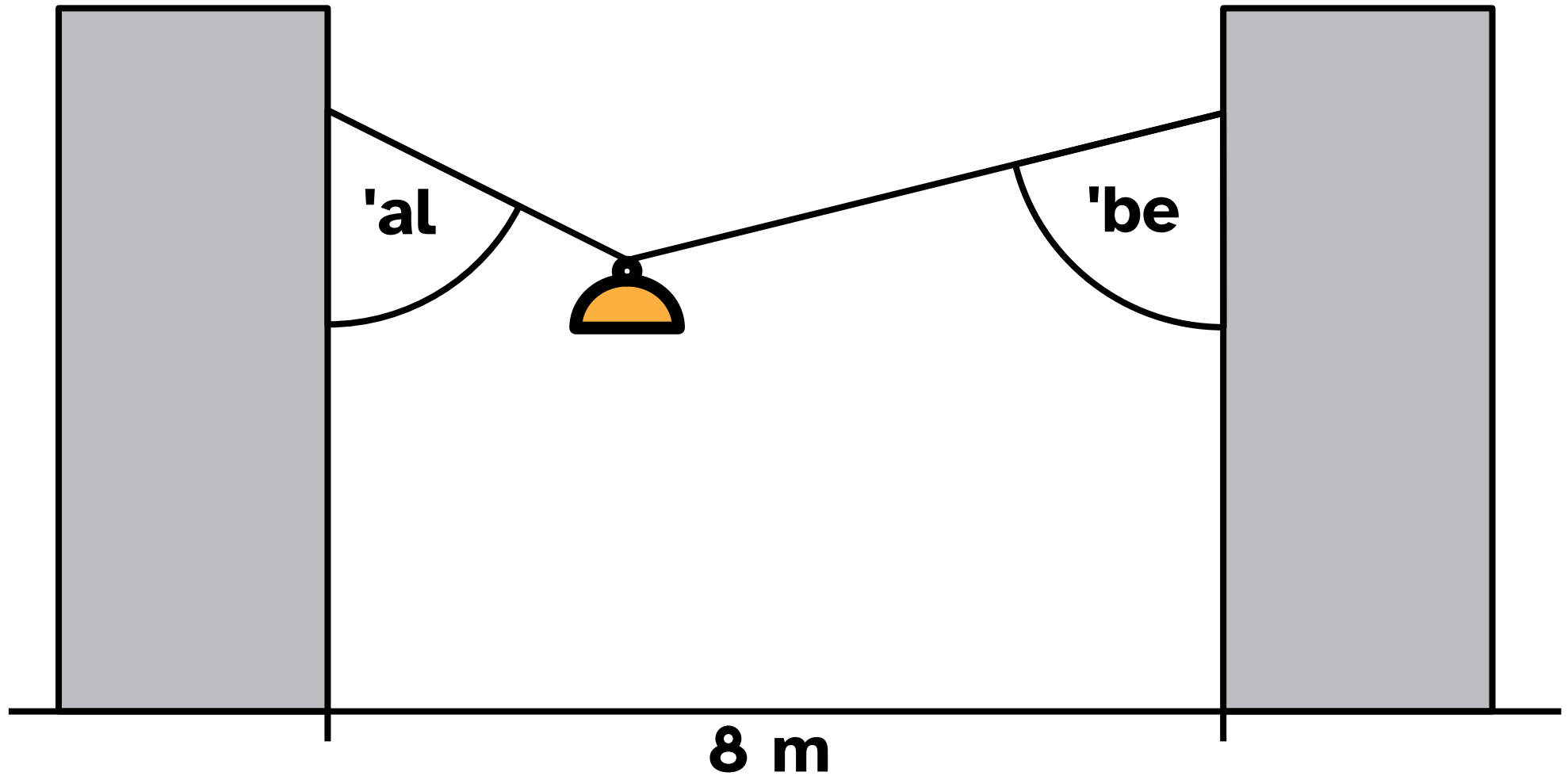
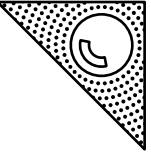

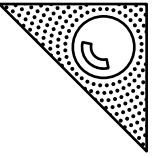

Fahrzeug

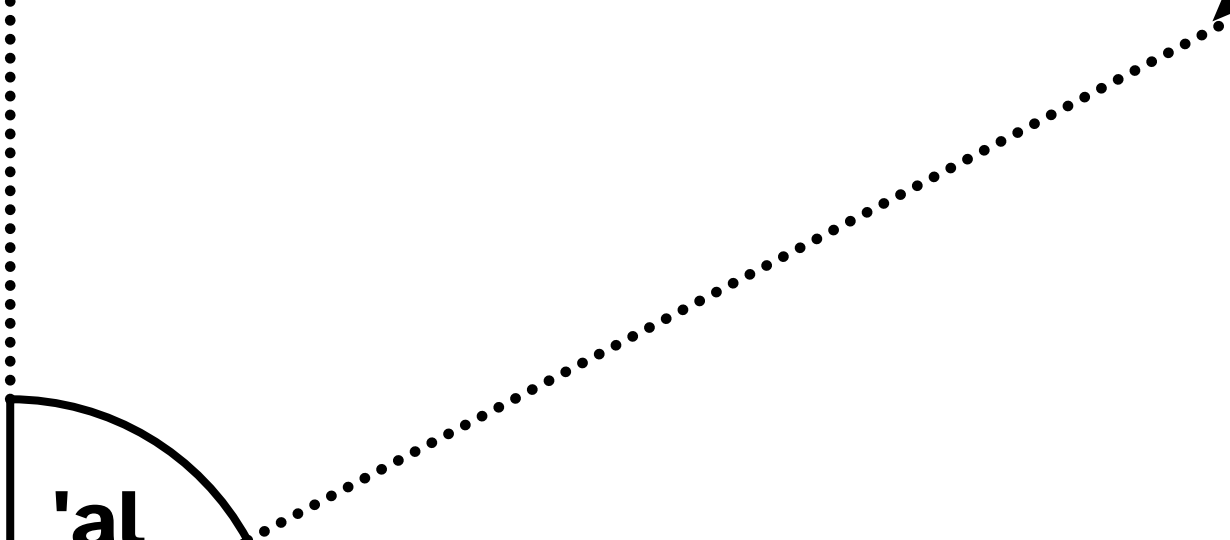
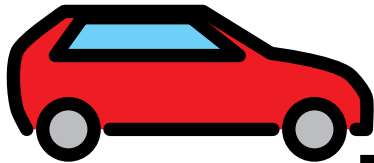

20 m

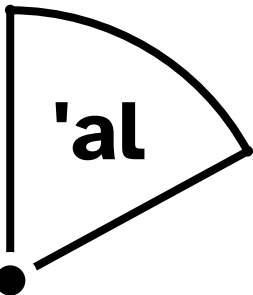

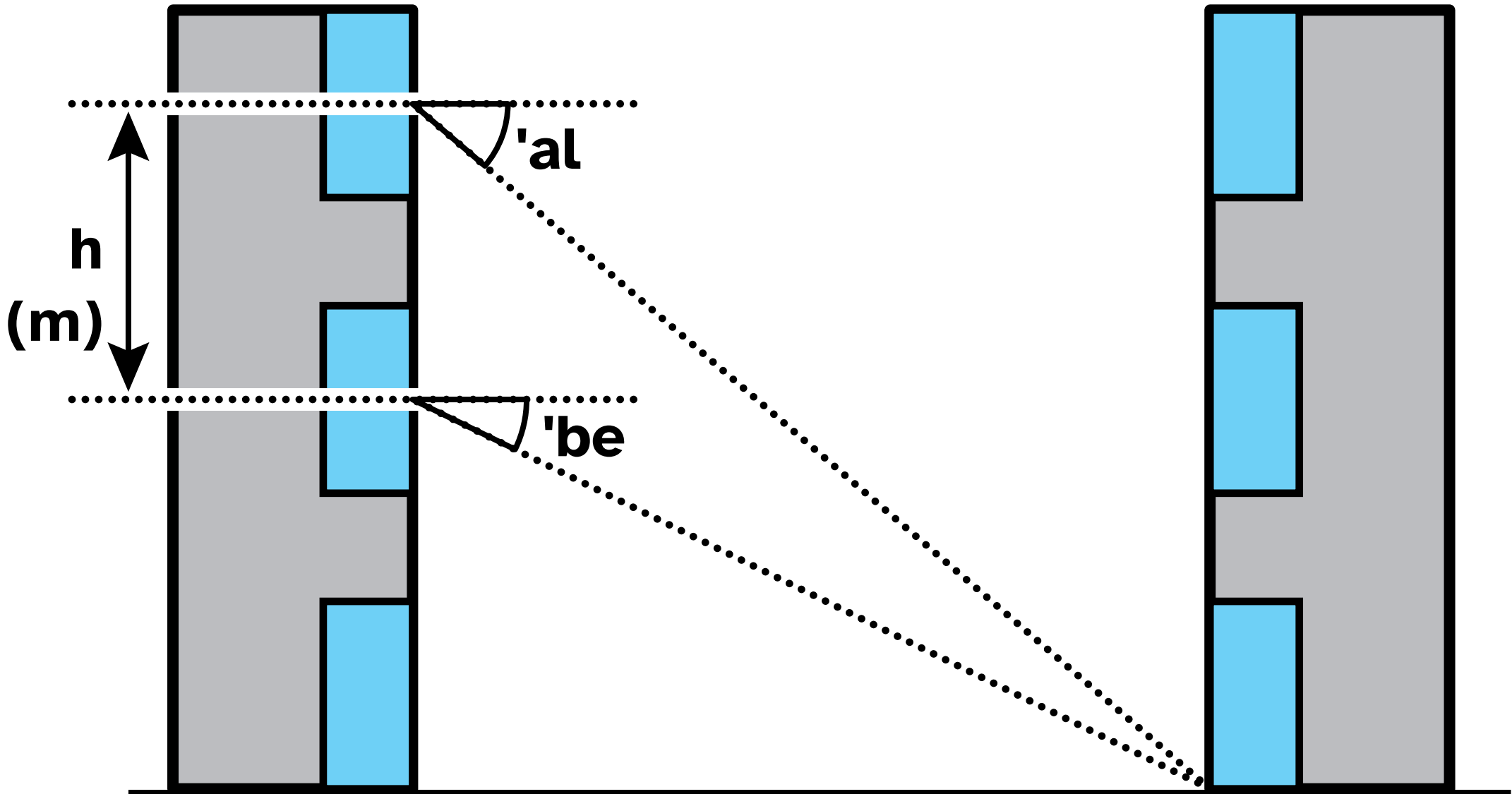
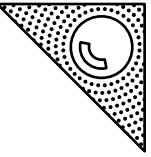

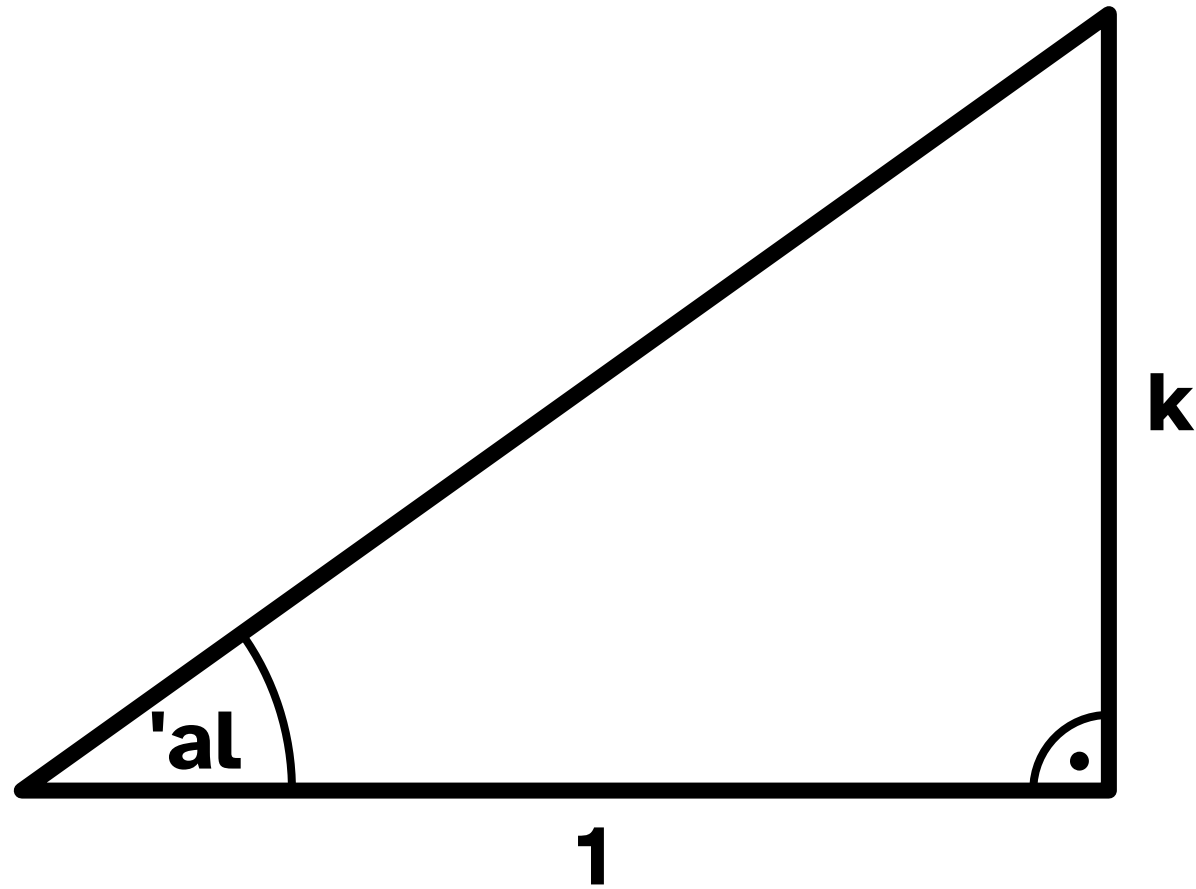
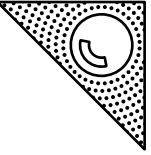

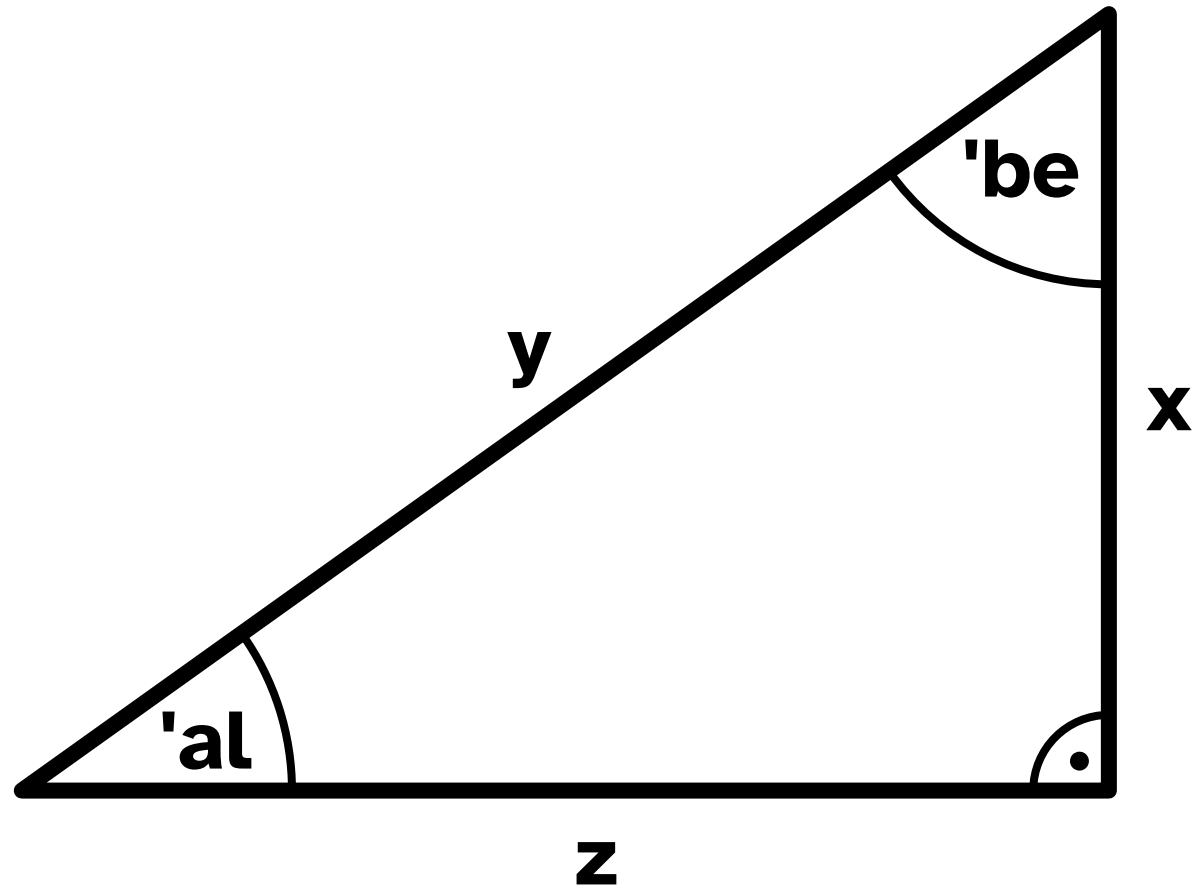
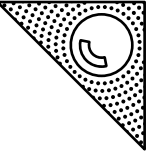

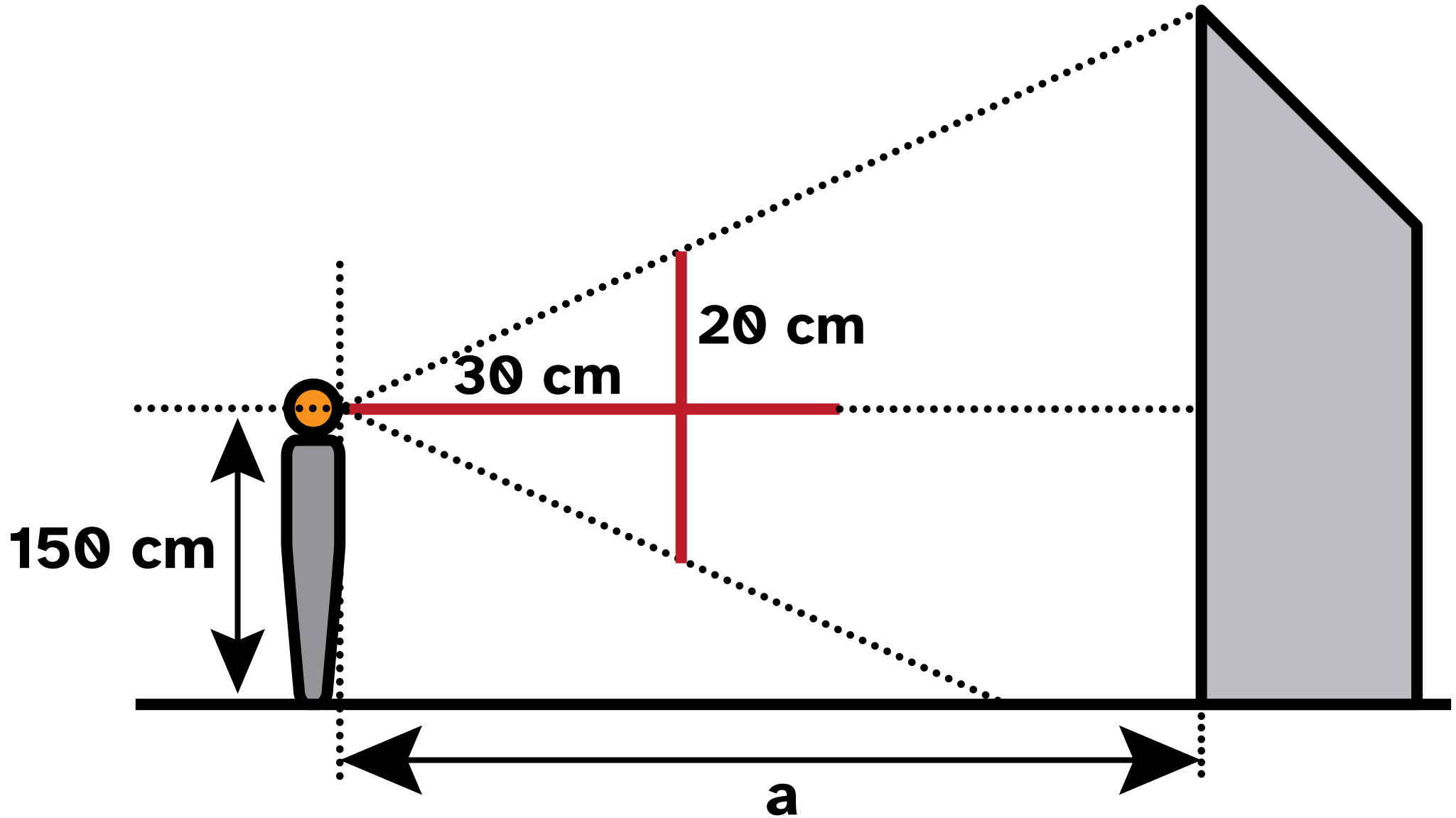
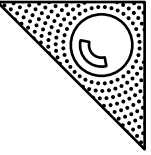

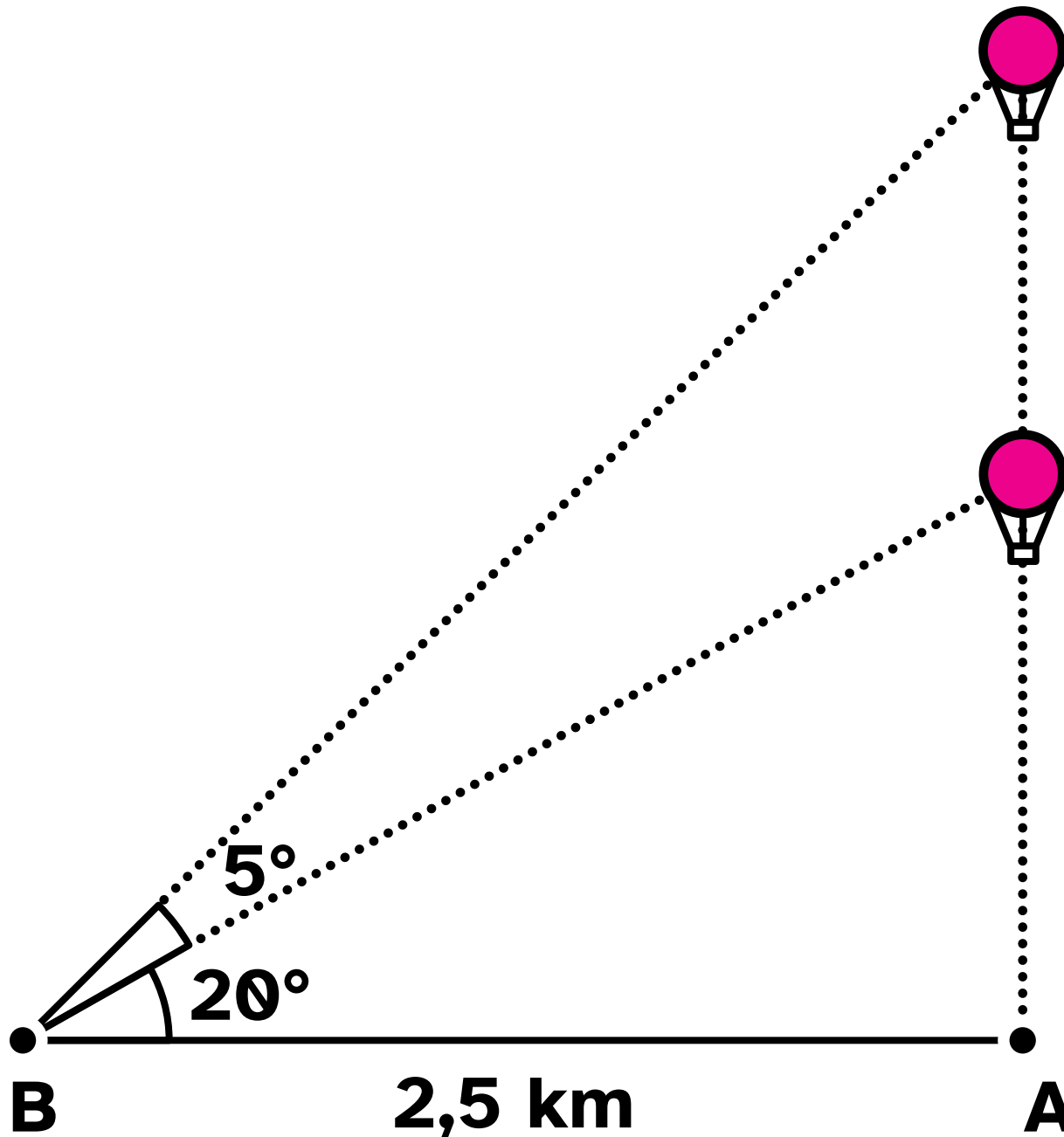
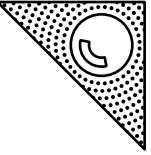

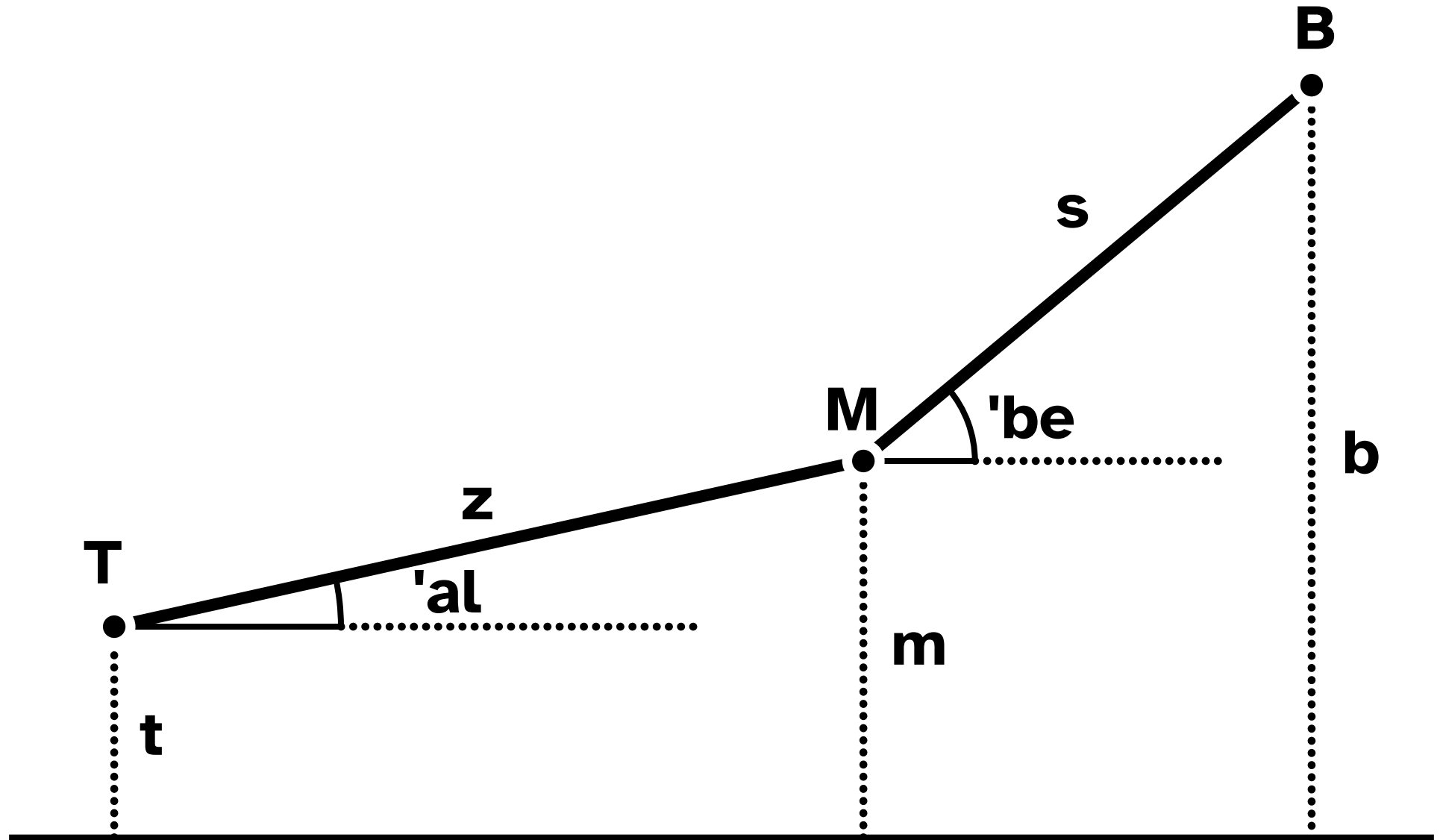
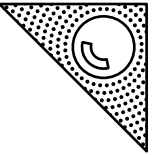

Skizze nicht maßstabgetreu

