



**Vergrößerte und aufbereitete Versionen
ausgewählter Grafiken aus dem Schulbuch**

Plus! 2



Grafiken: Tomáš Batha

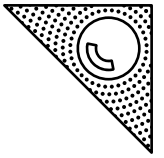

Plus 2

Teil 1, Seiten 1-110

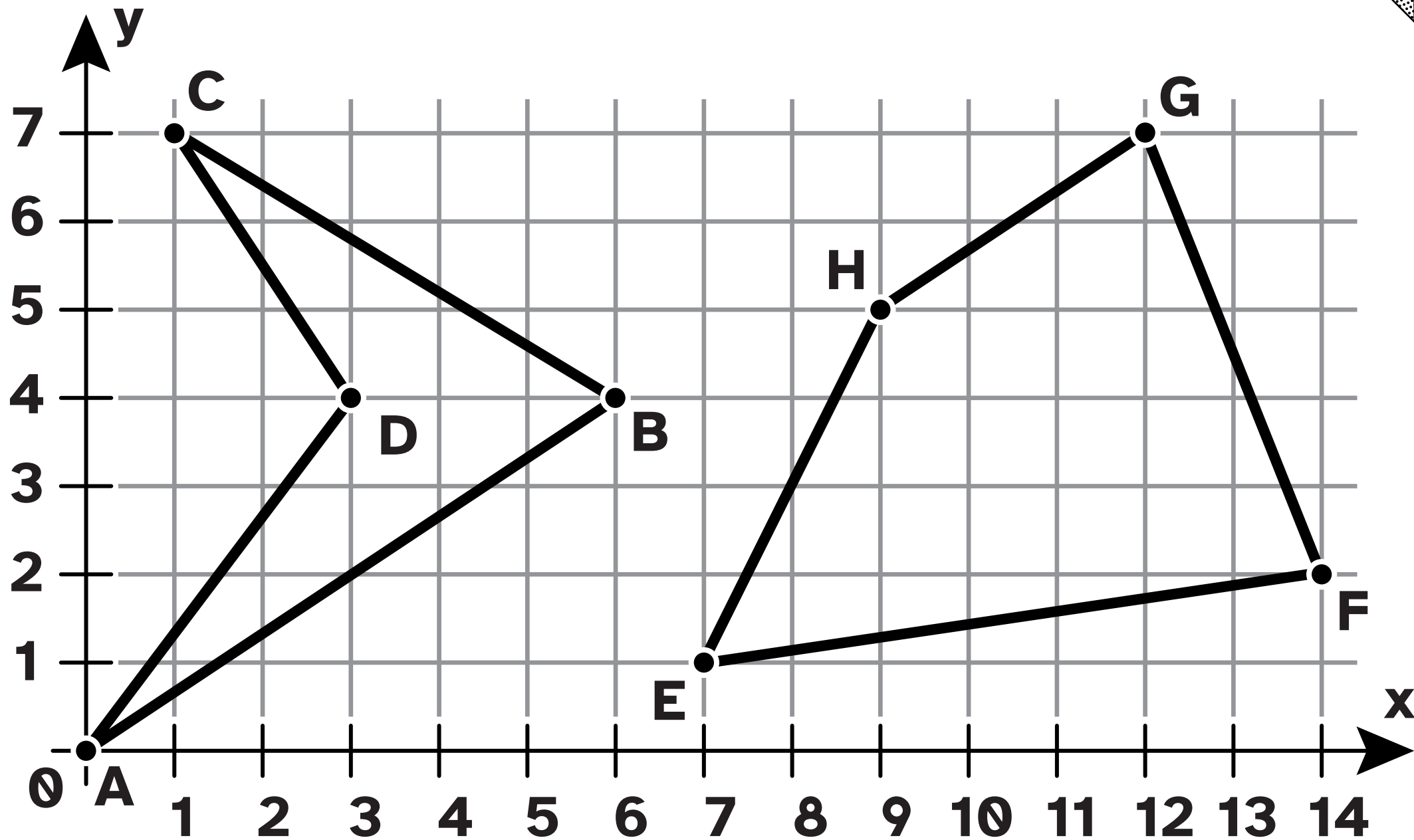
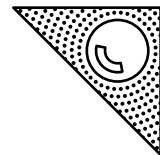

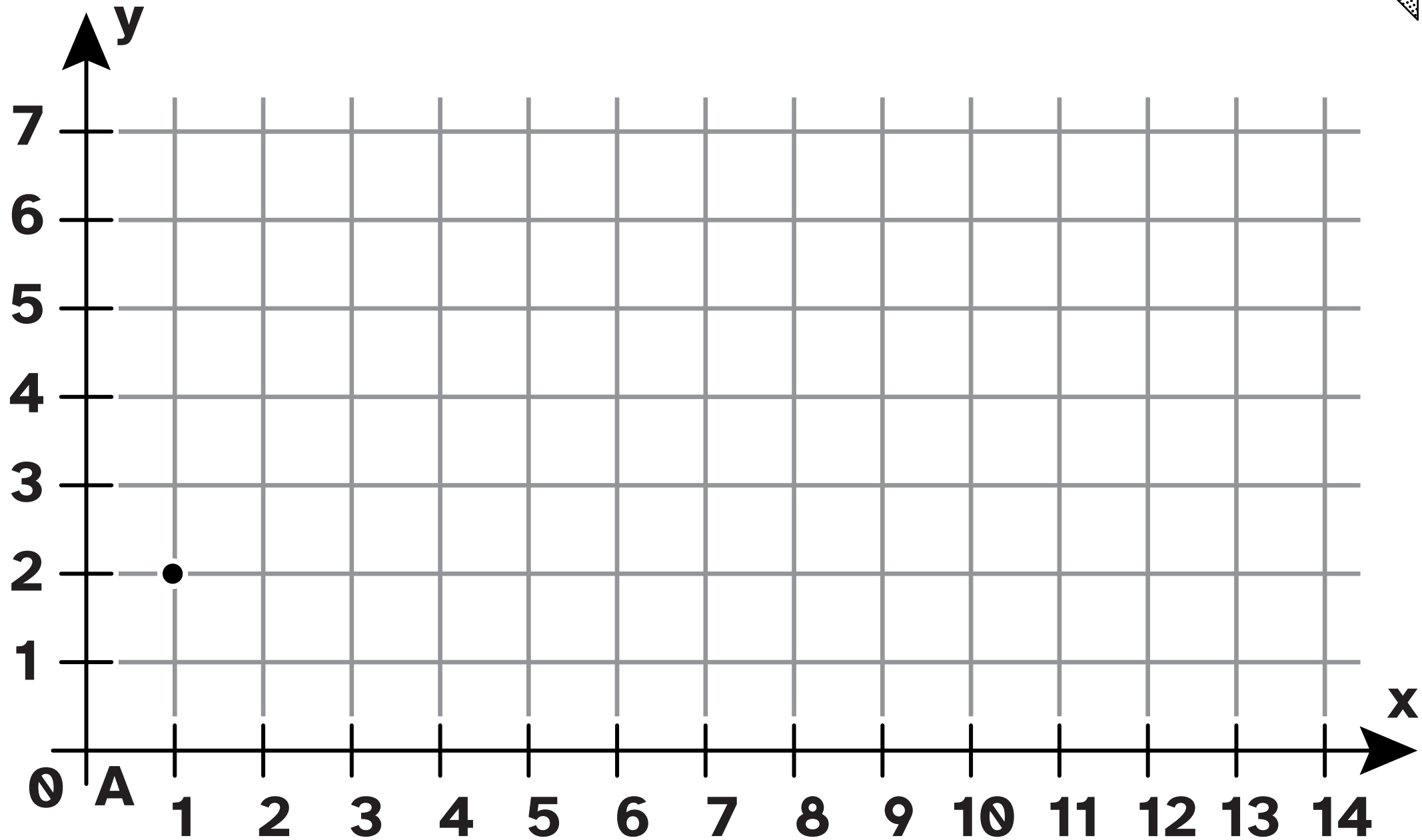
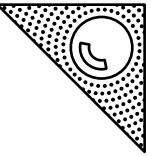

Plus2

S.36 120

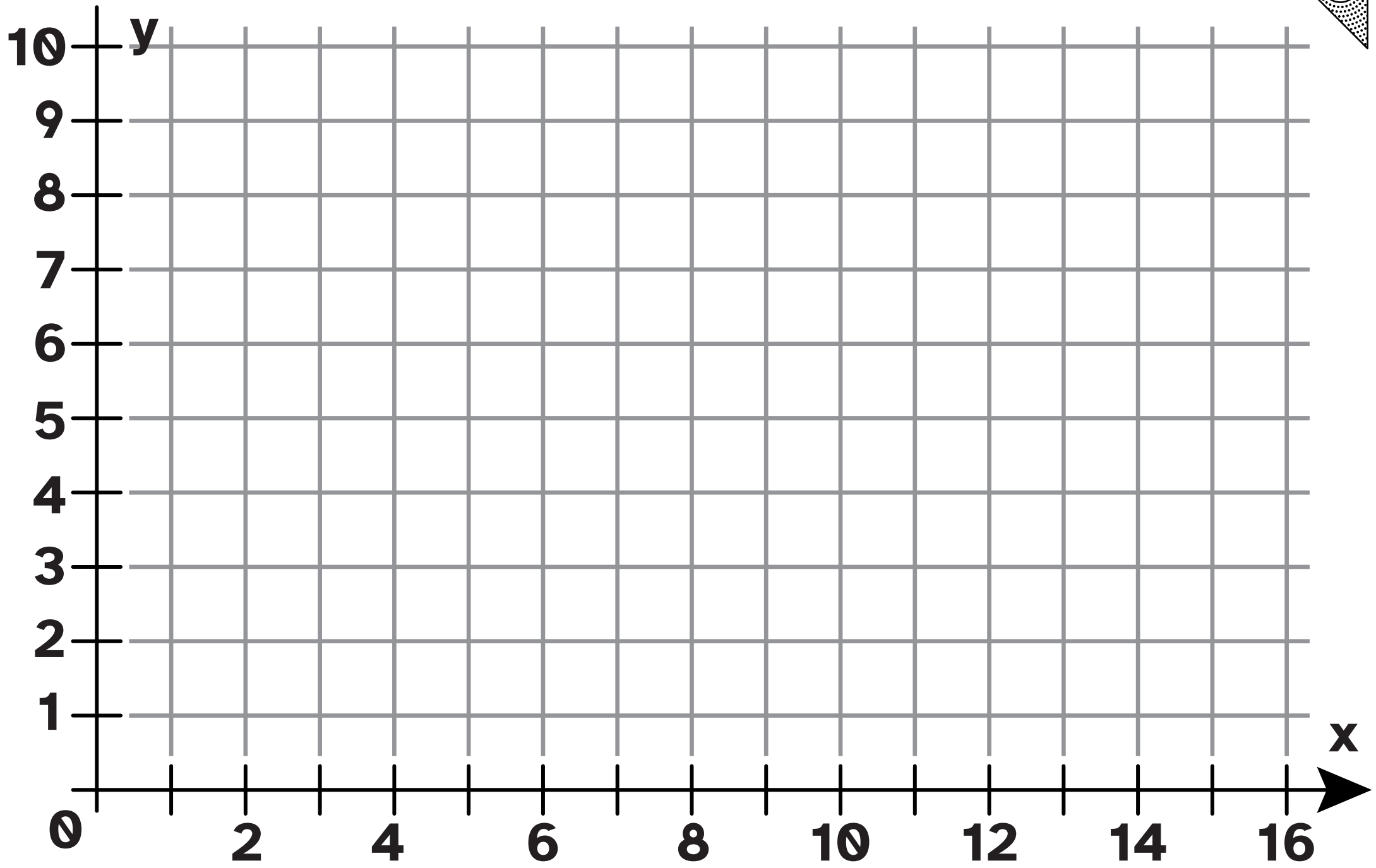
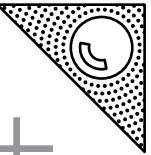

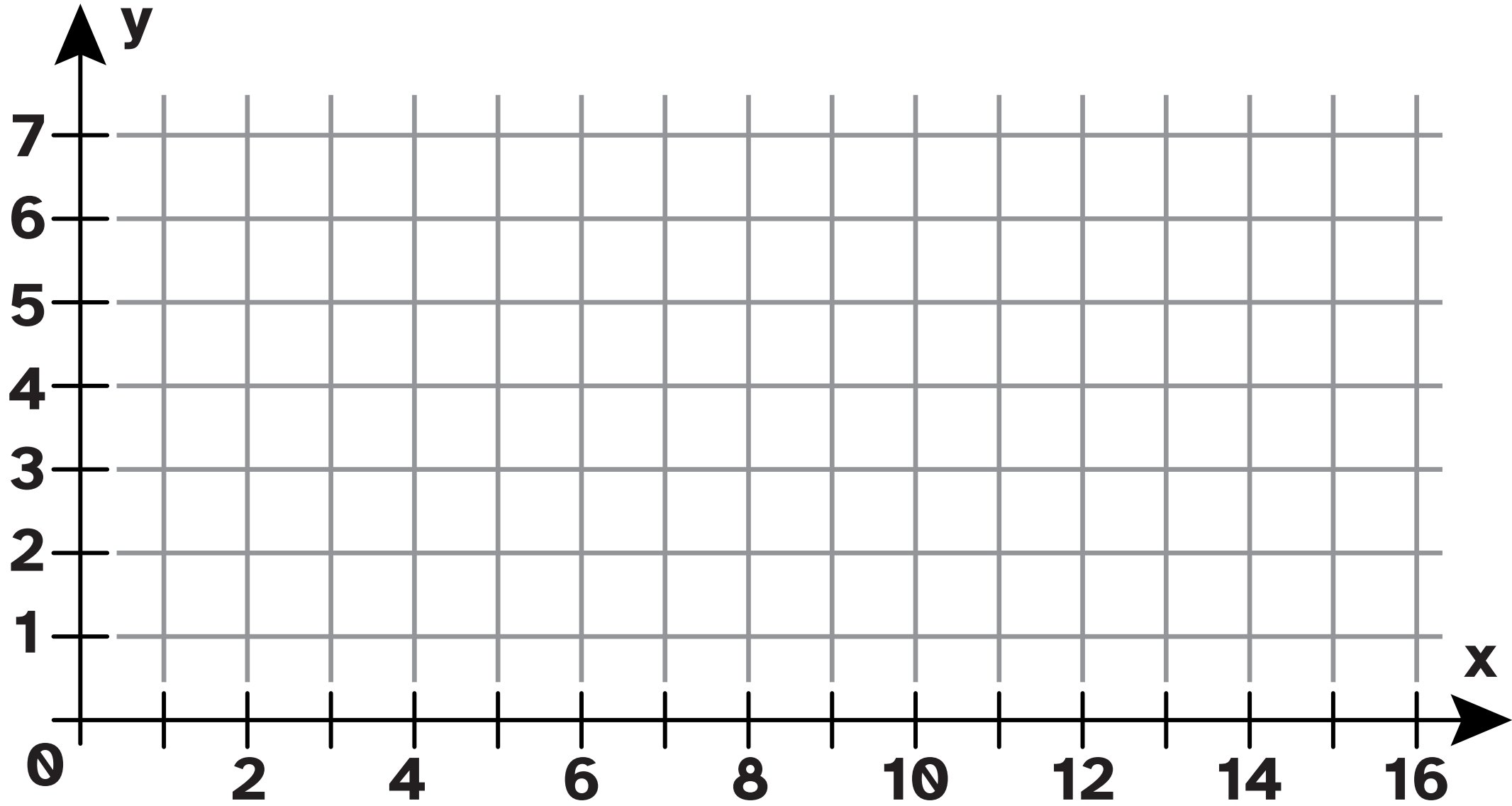
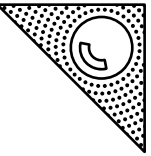

Plus2

S.42 132

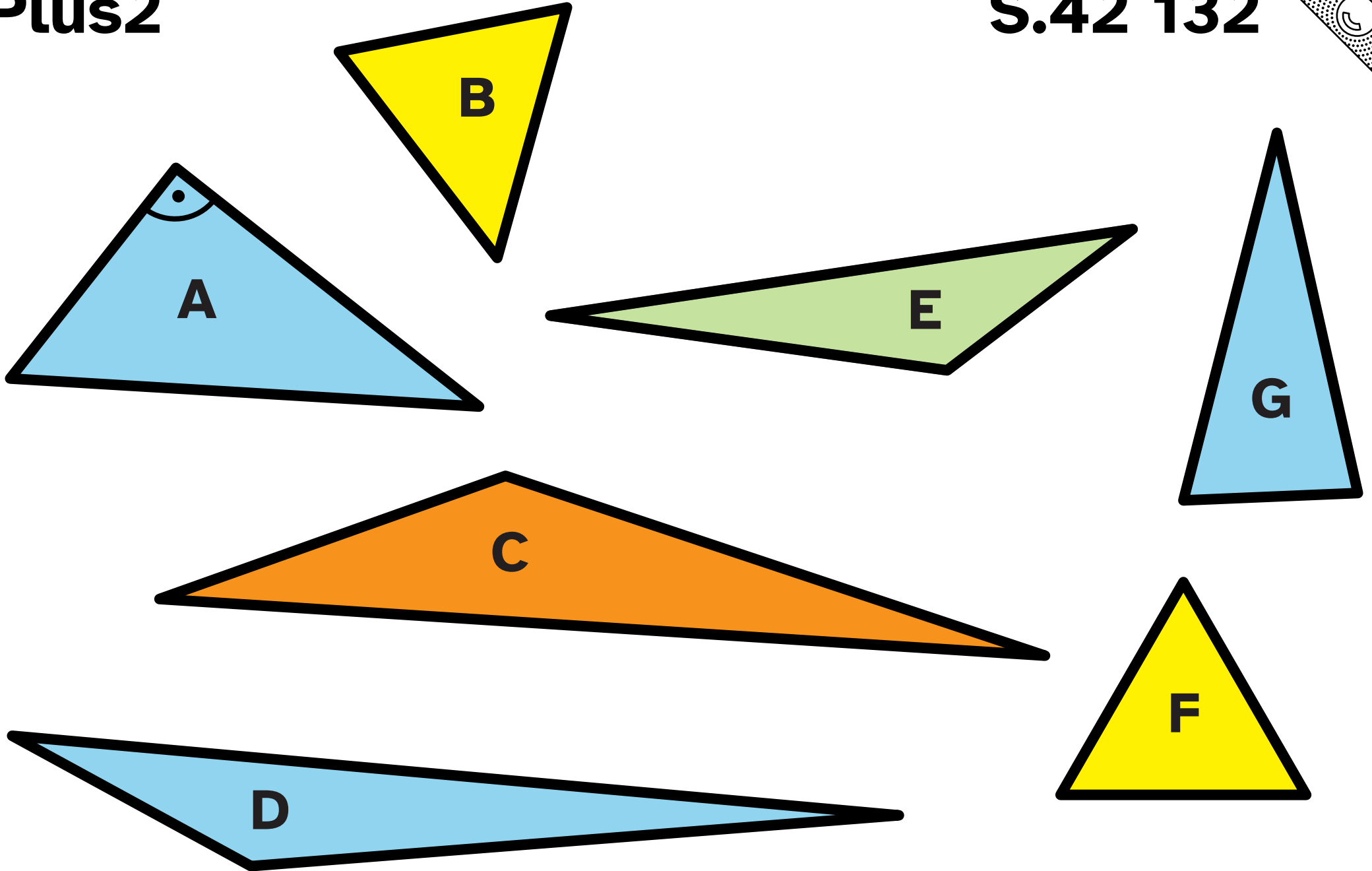
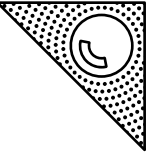

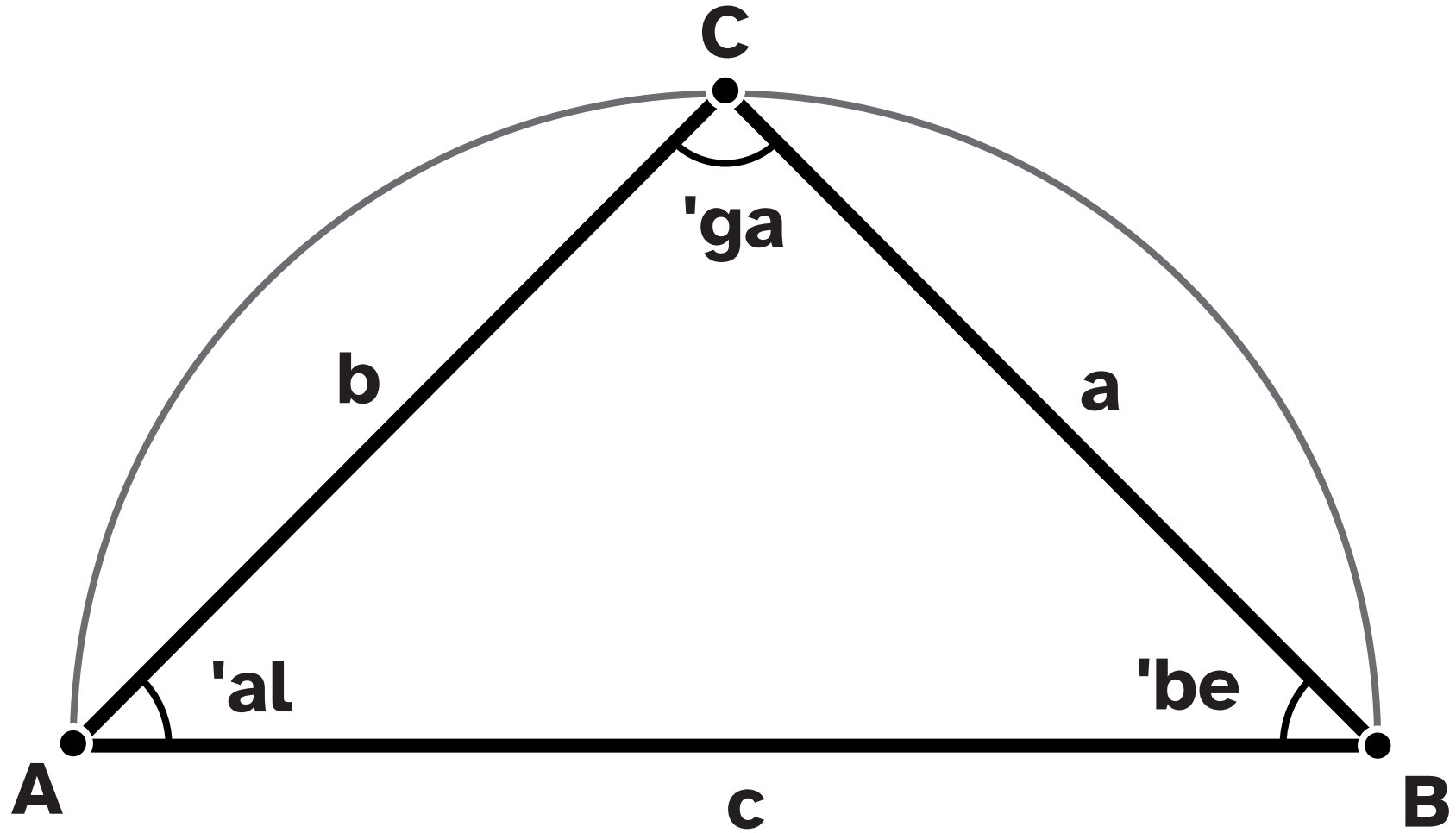
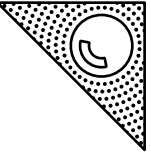

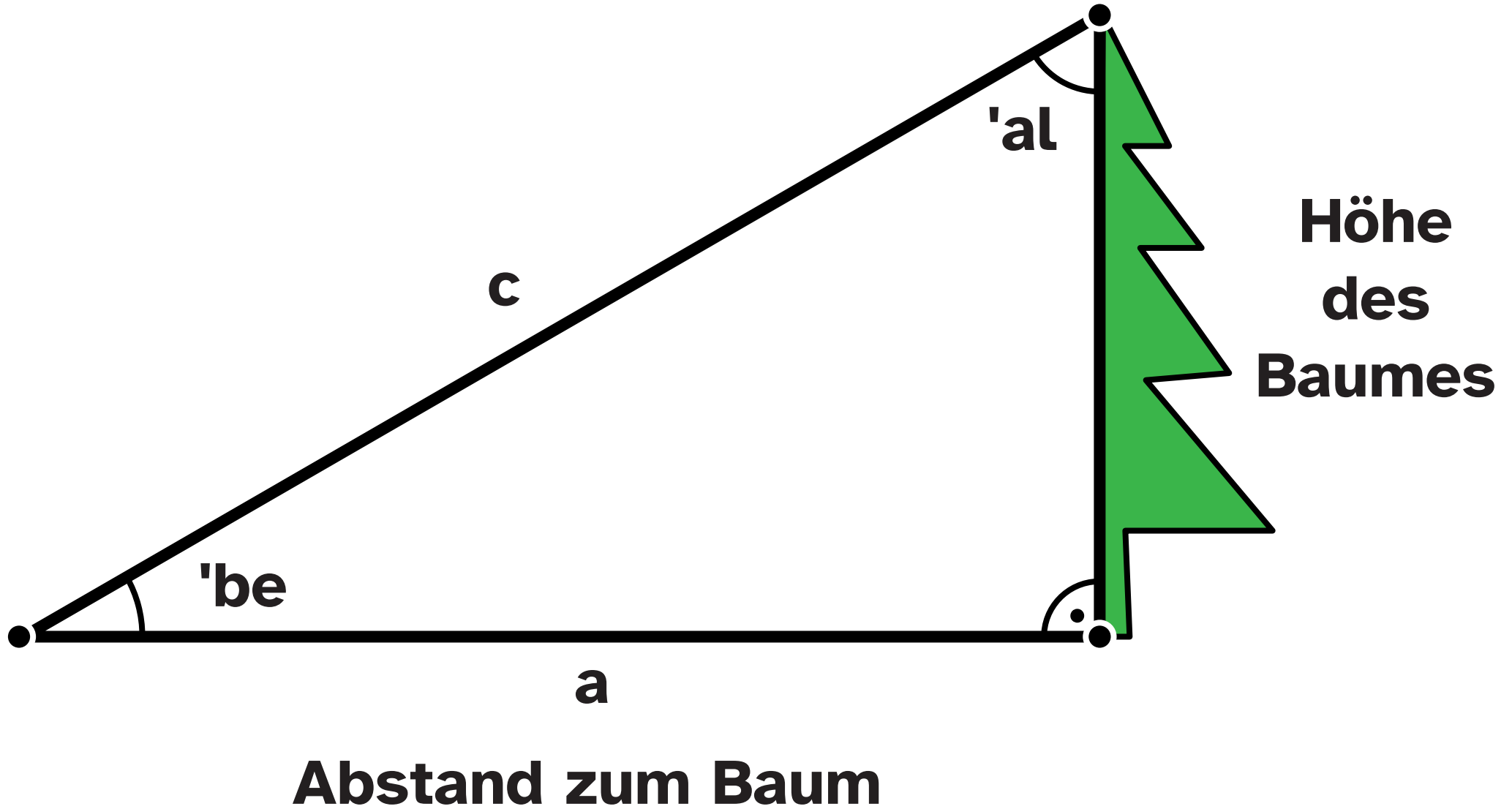
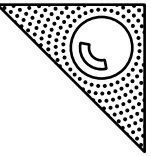

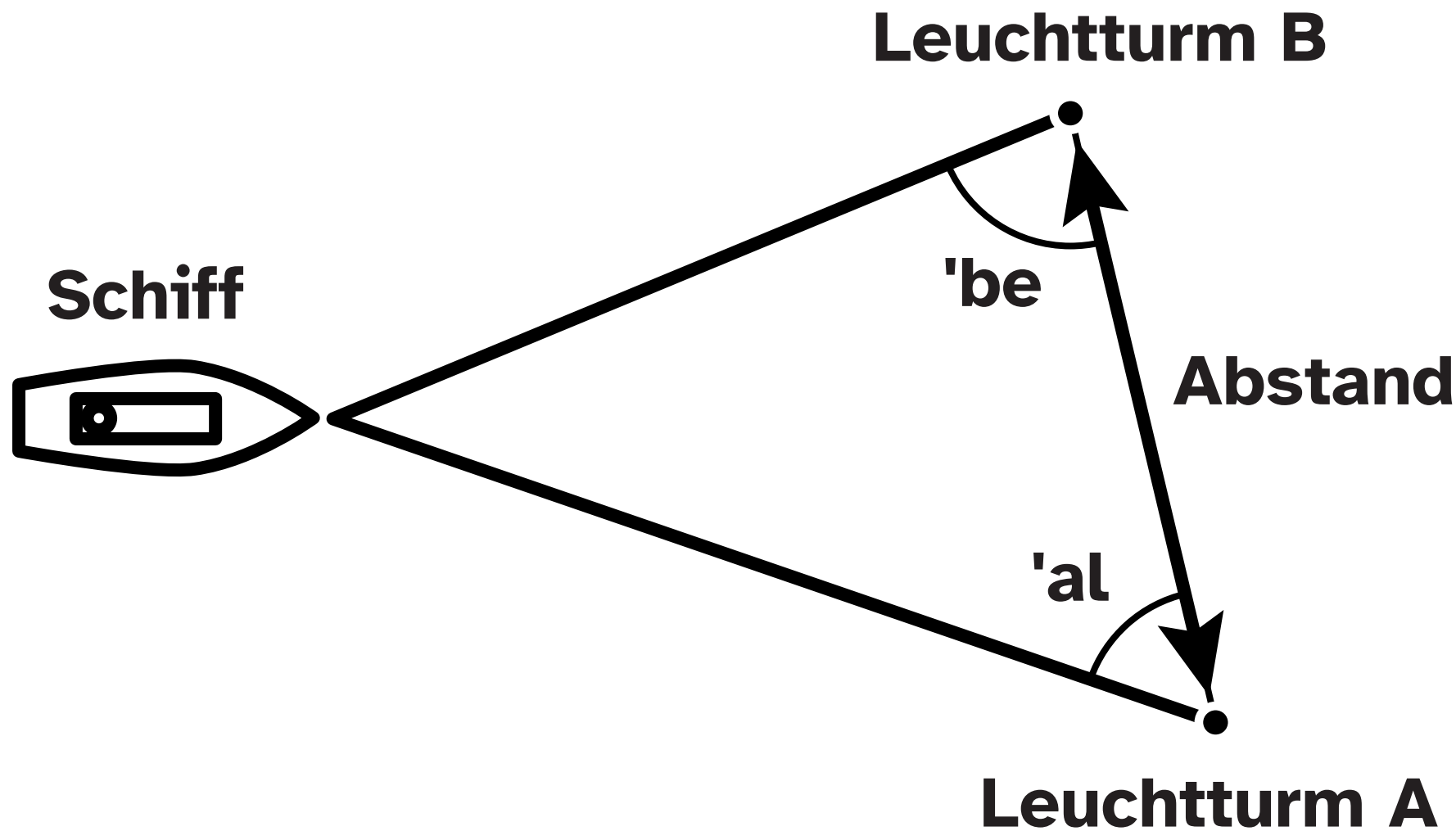
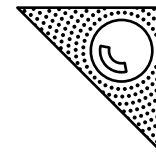

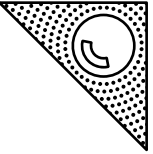

Maßstab: 1 /1000

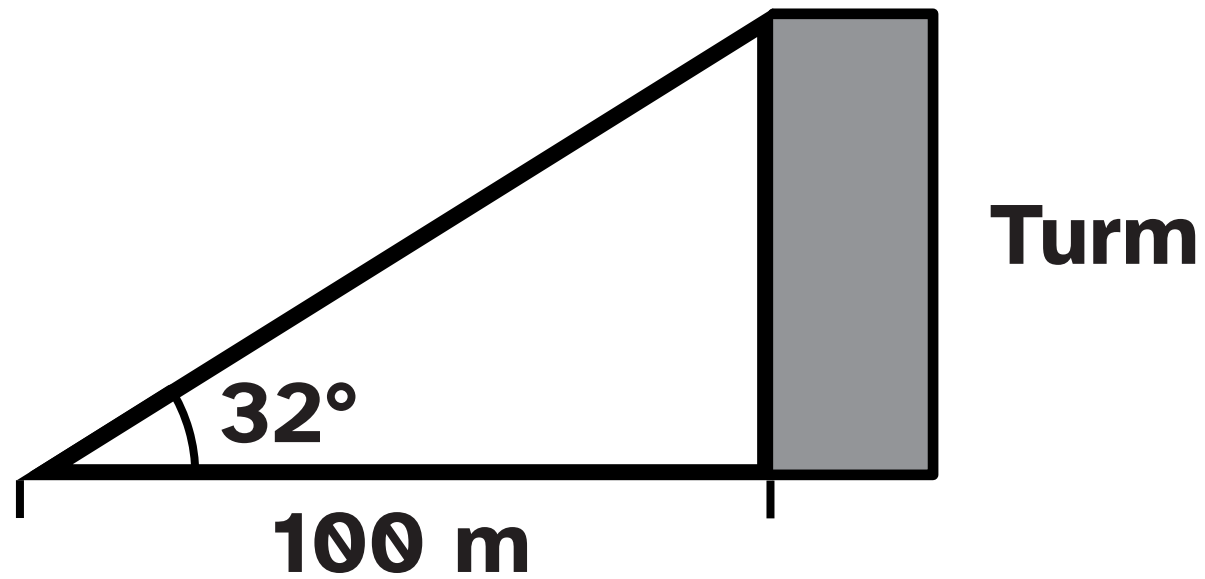

Plus2

S.46 160

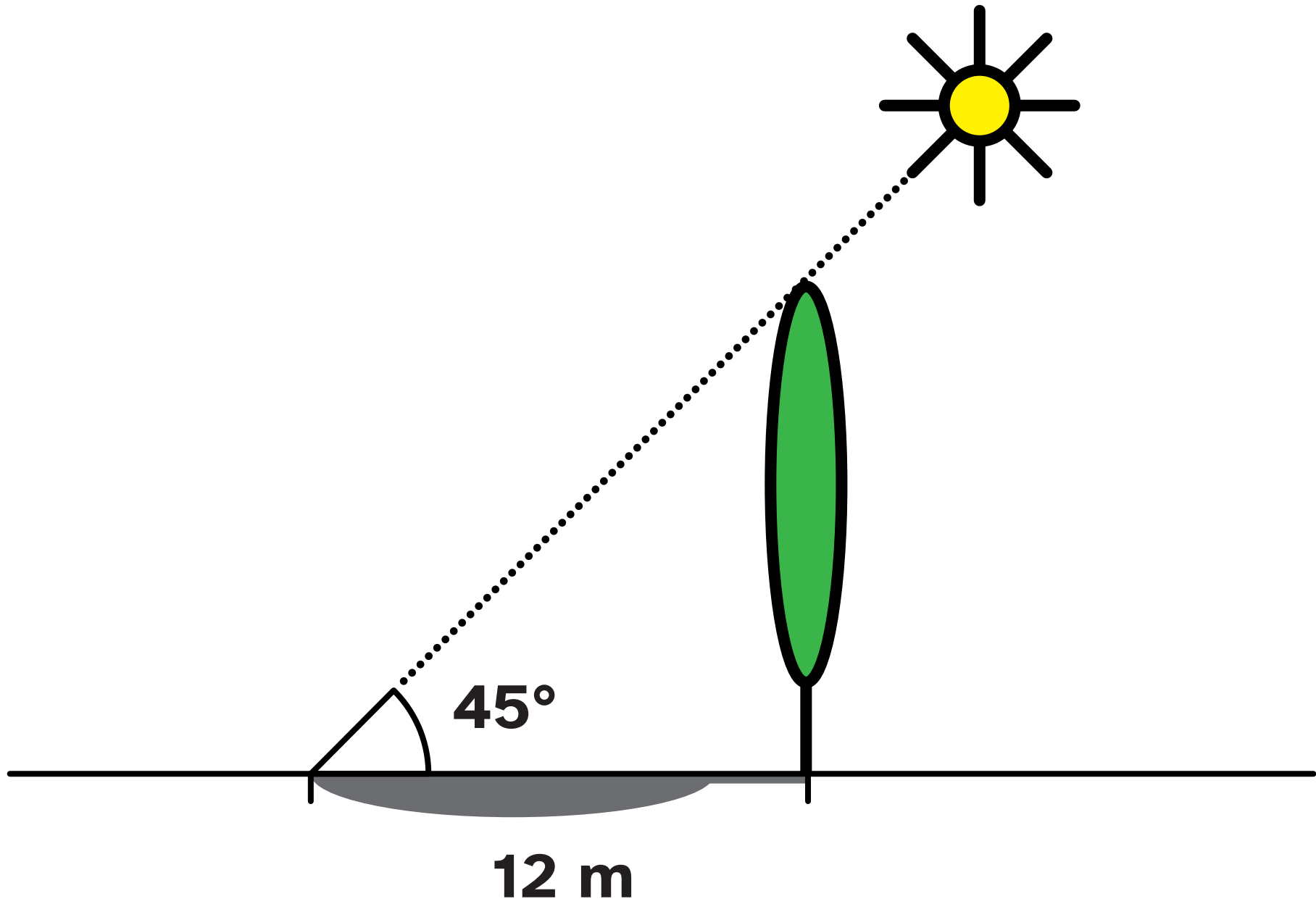
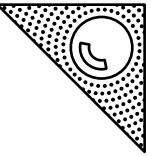

Plus2

S.48 162 1/2

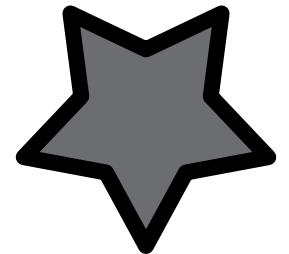
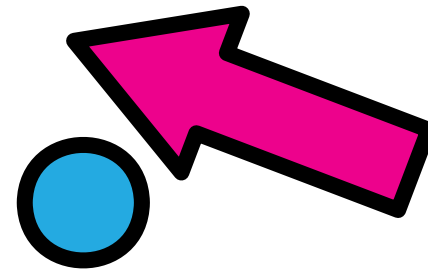
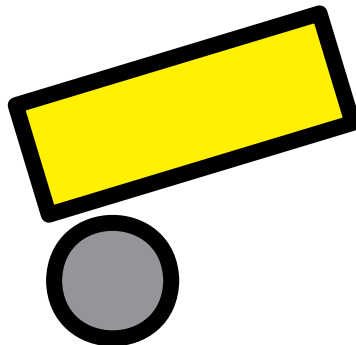
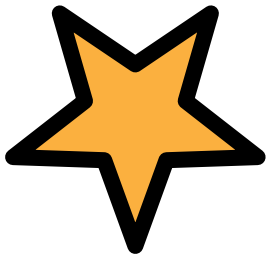
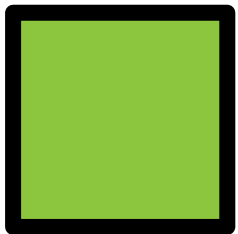
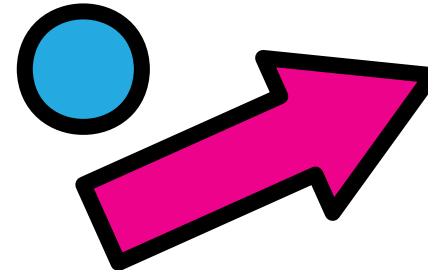
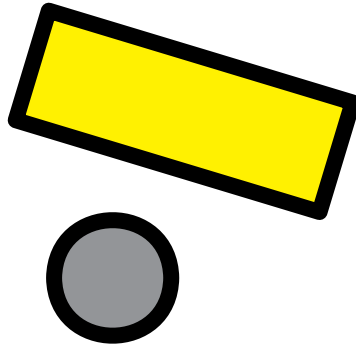
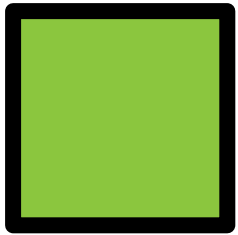
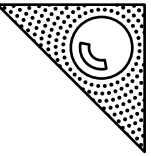

Plus2

S.48 162 1/2

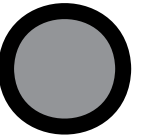
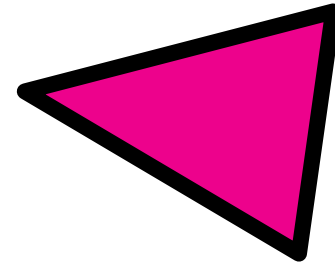
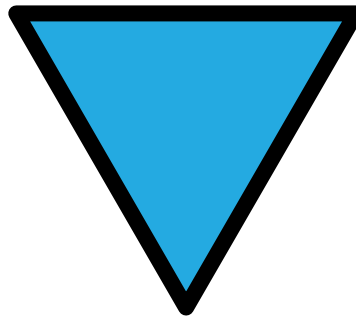
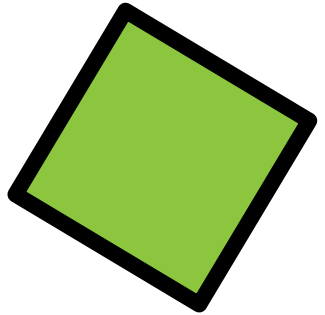
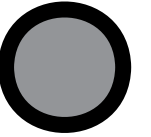
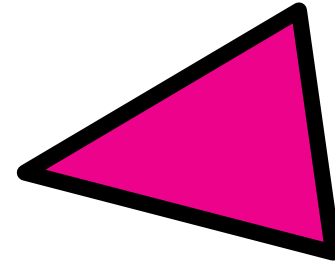
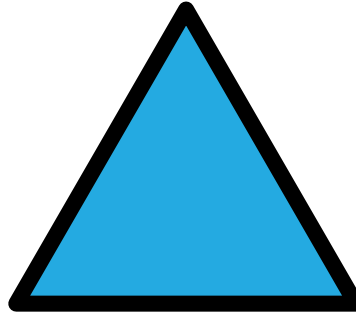
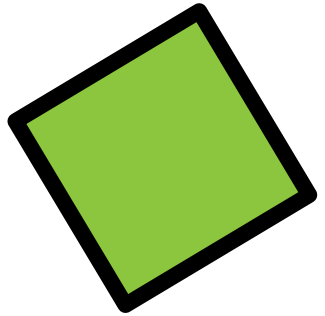
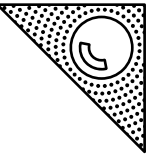

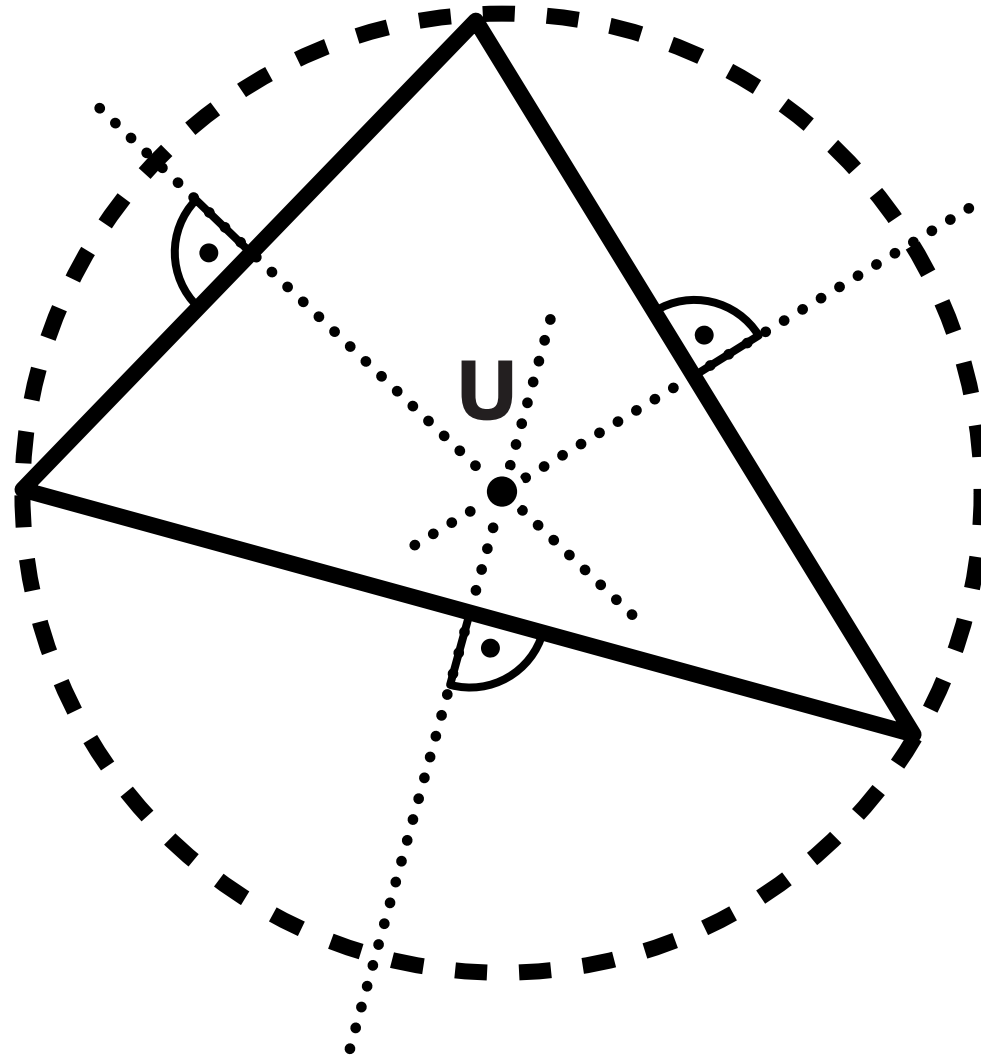
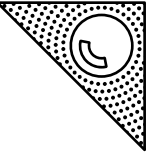

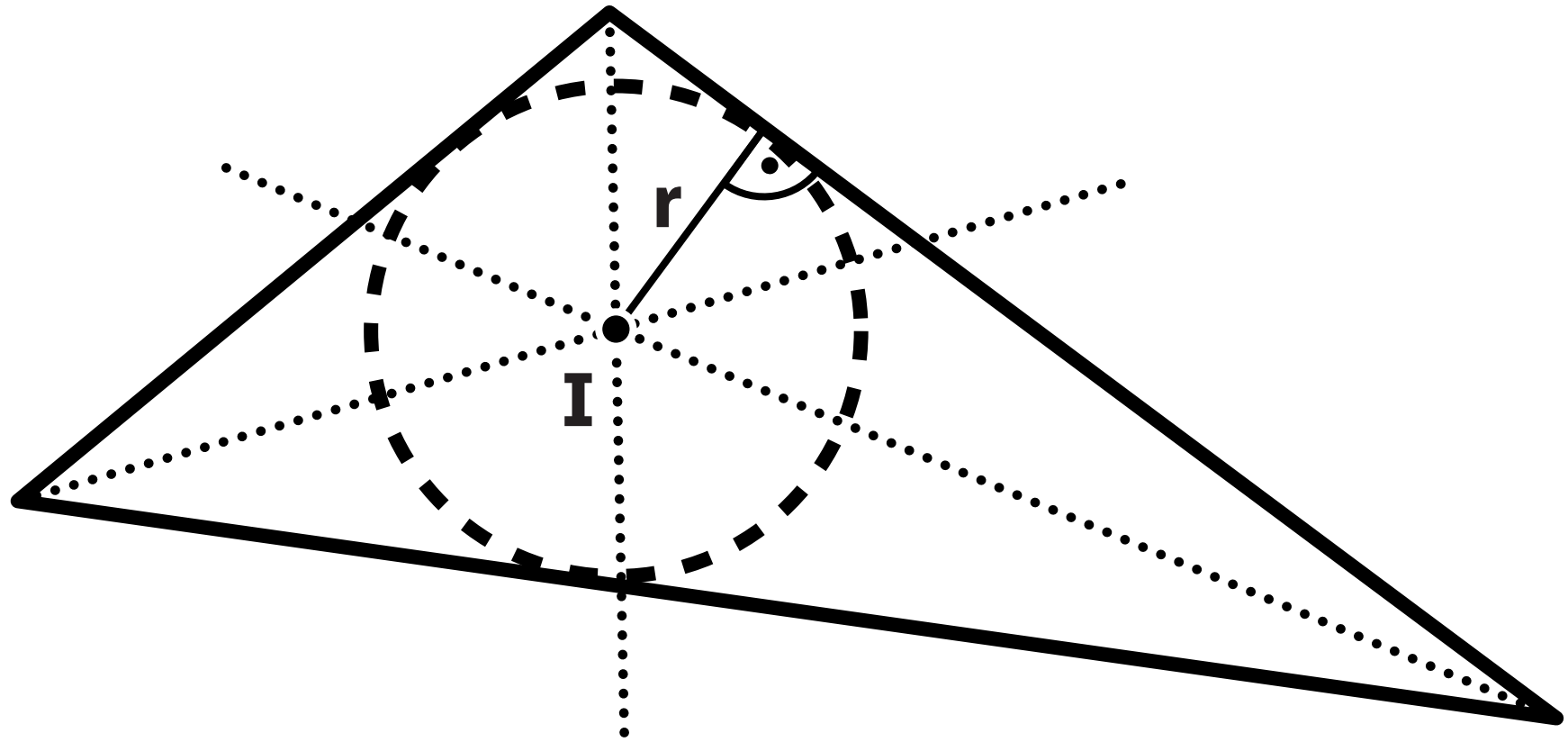
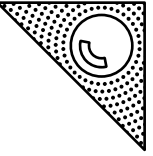

Plus2

S.54 190

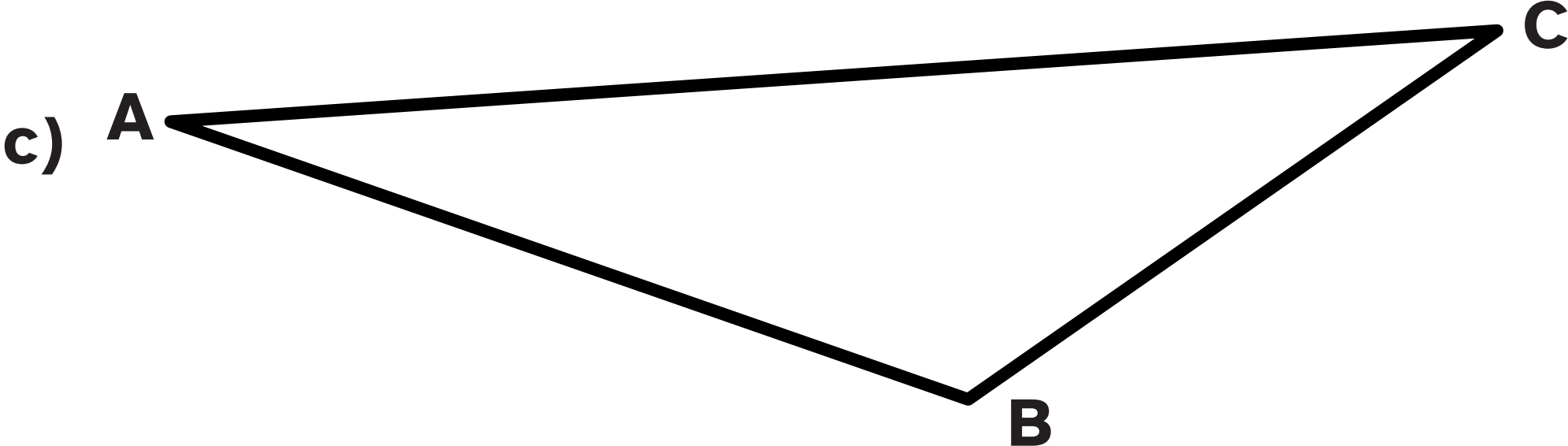
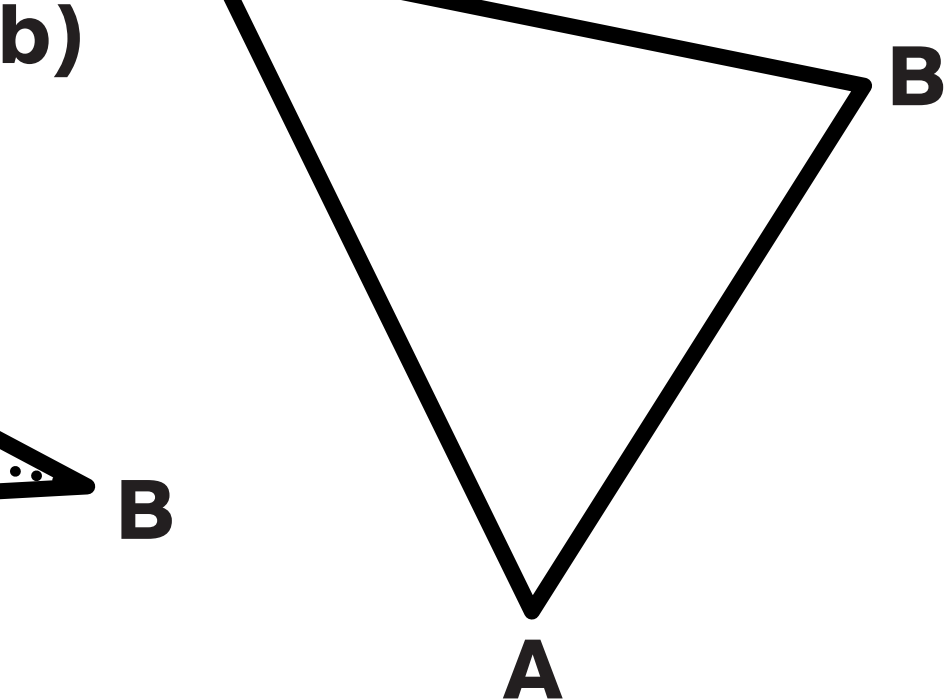
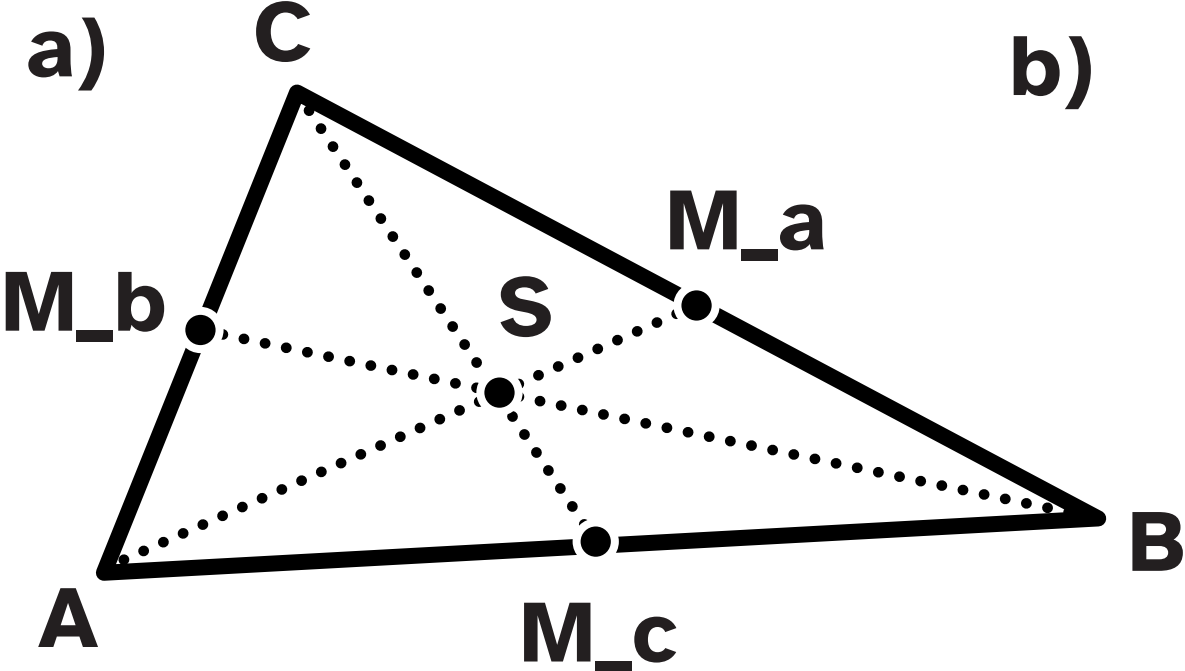
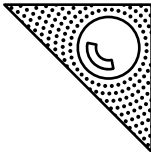

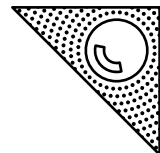

a) h_b

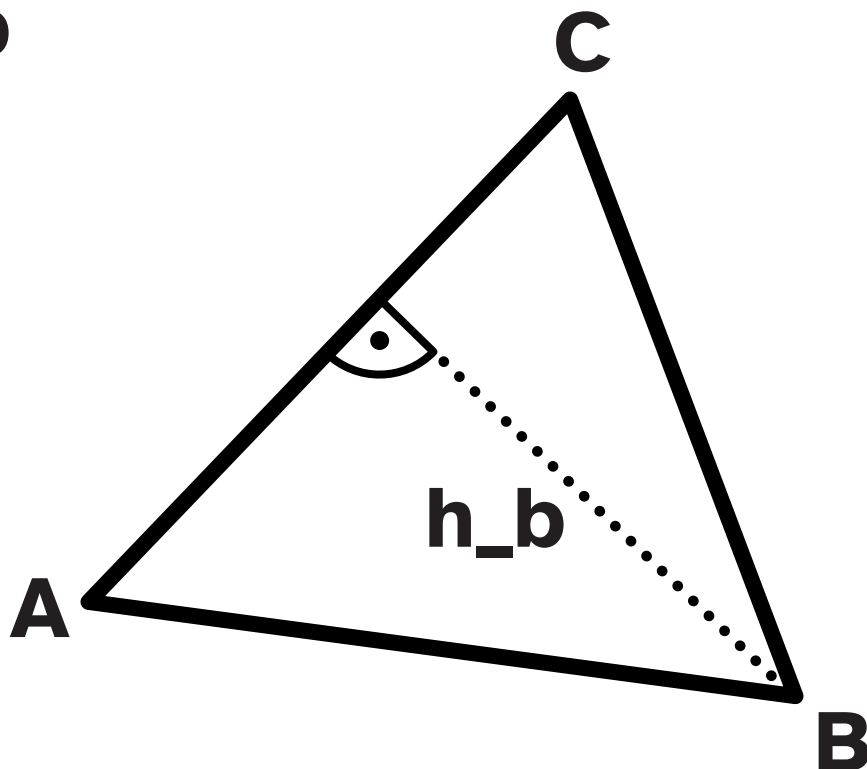

b) h_c

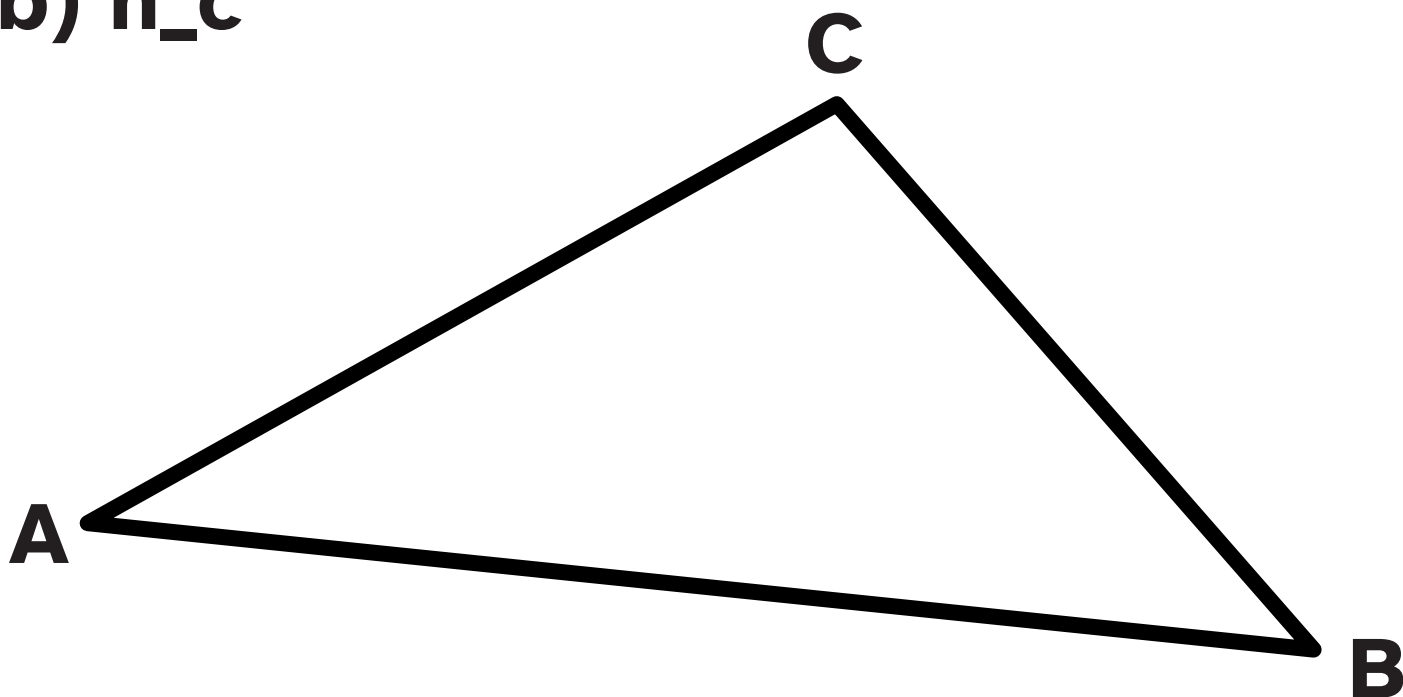

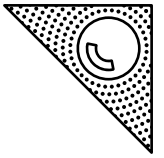

c) h_a

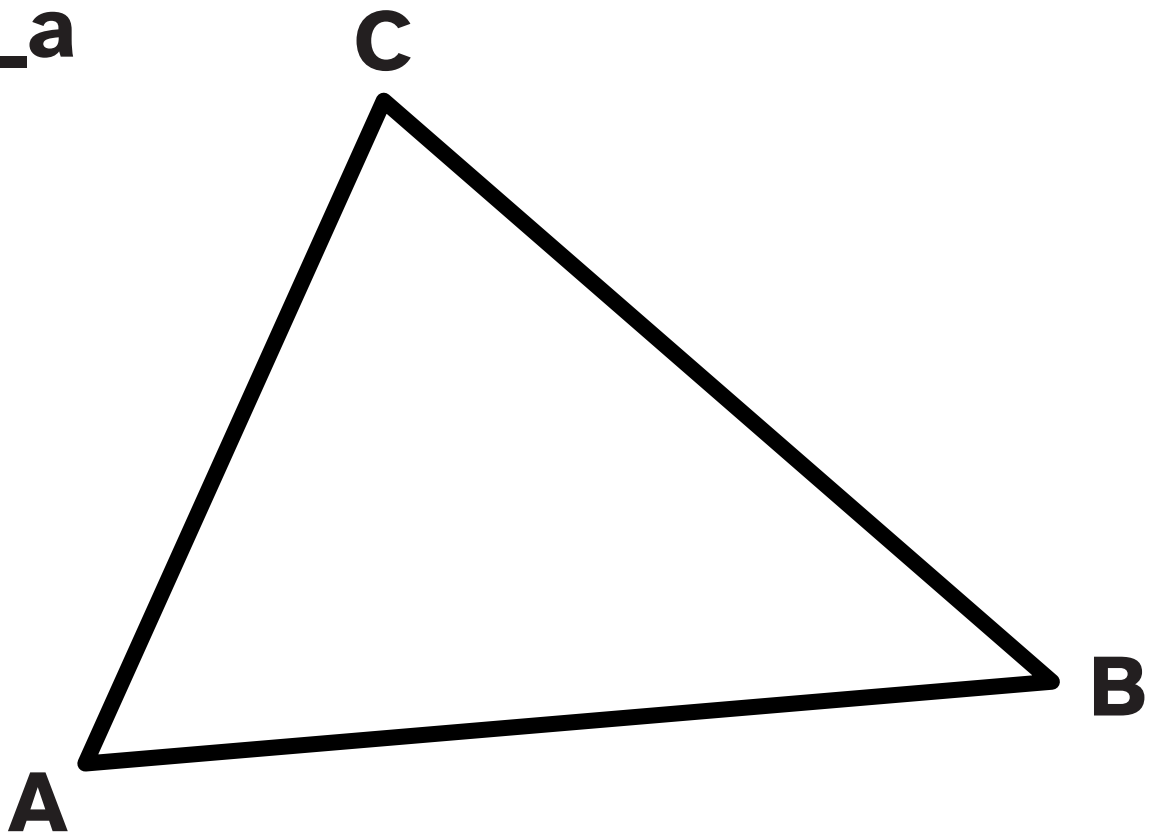

d) h_a

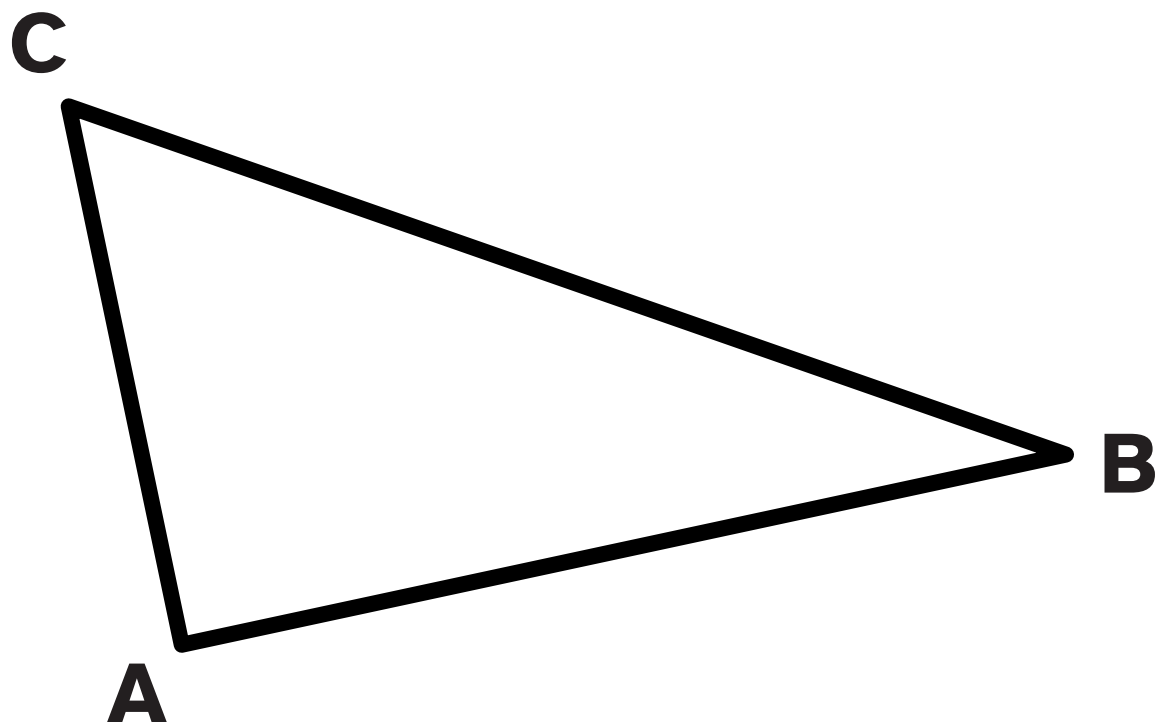

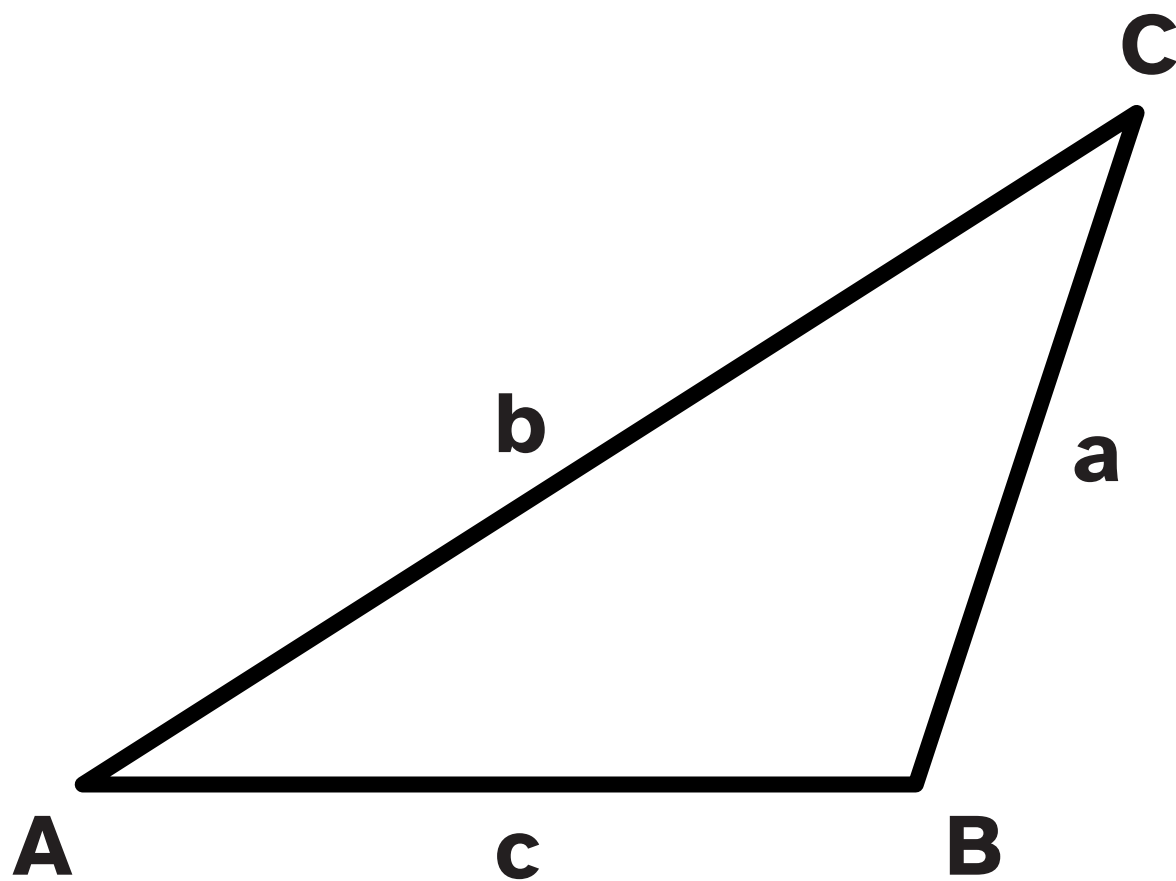
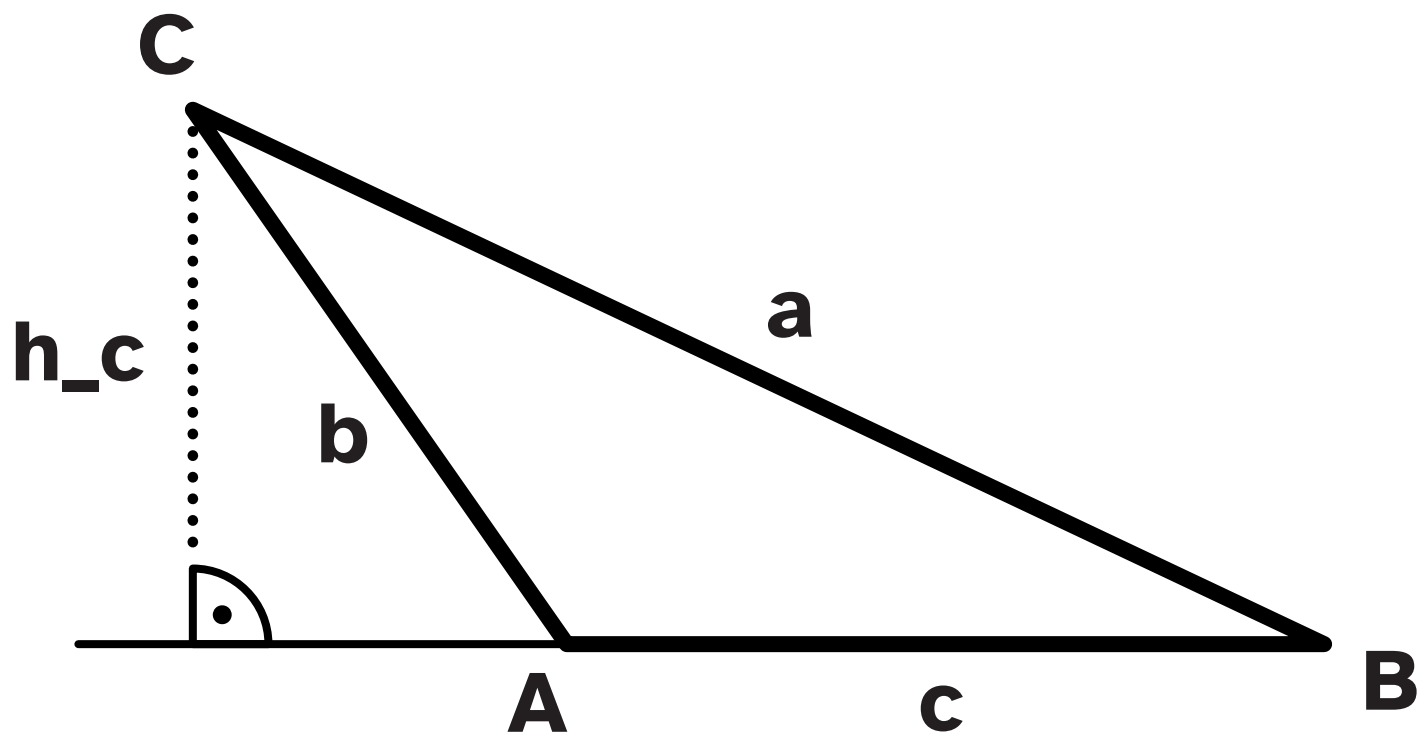
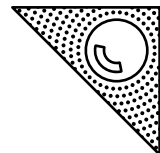

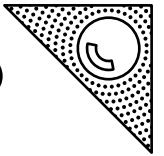

1 Ganzes



1 Ganzes:



Drittel:



Sechstel:



Zwölftel:

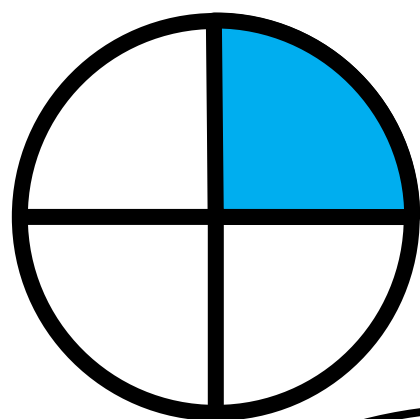

Zähler *2

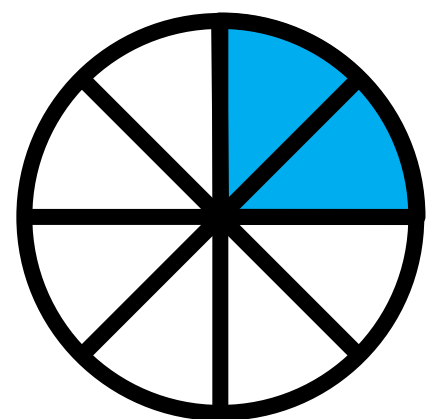

$1/4$

Nenner *2

$2/8$

Plus2

S.98 393

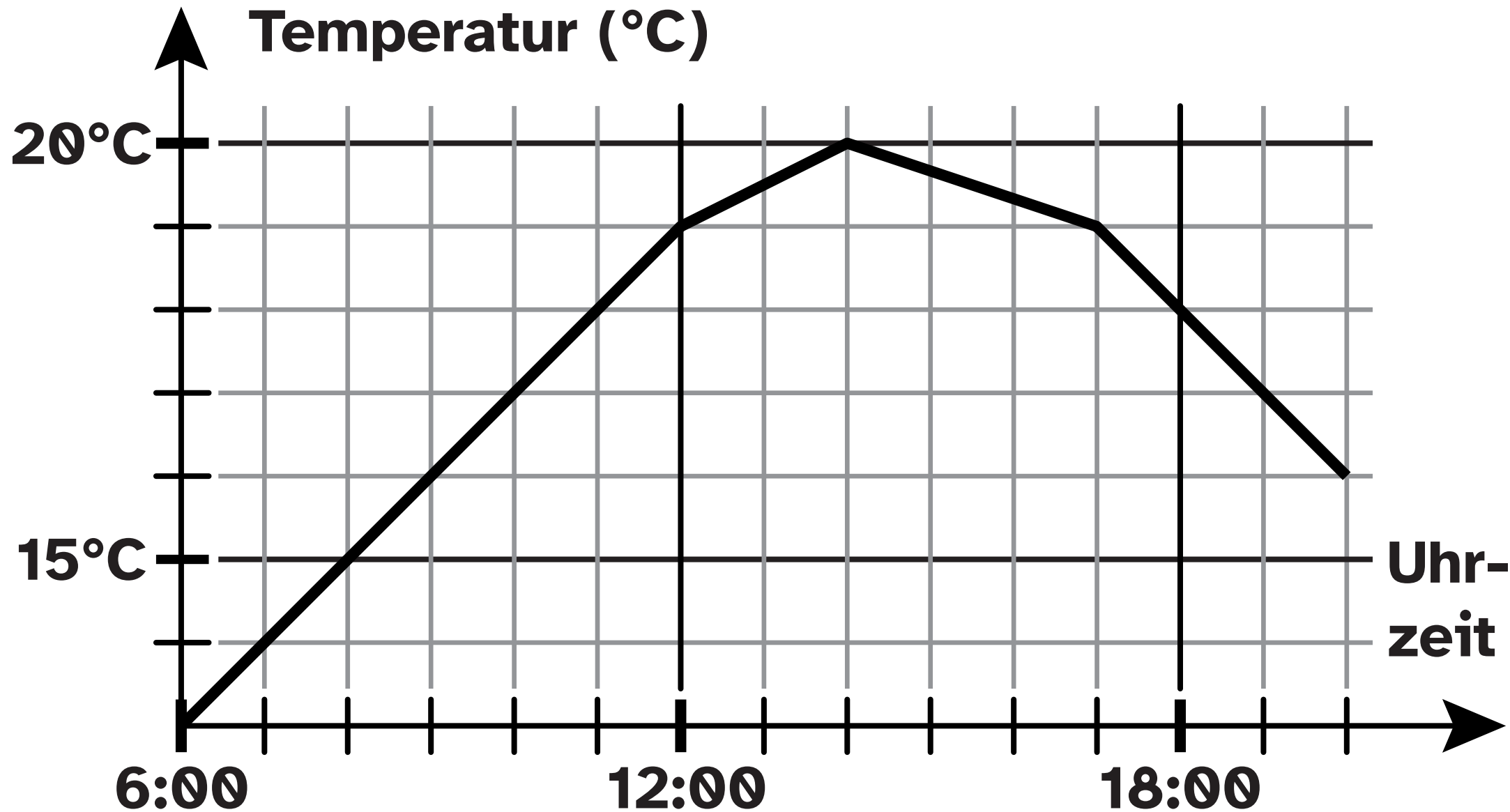
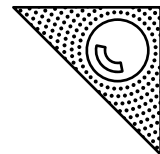

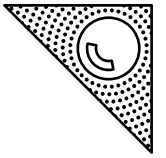

216

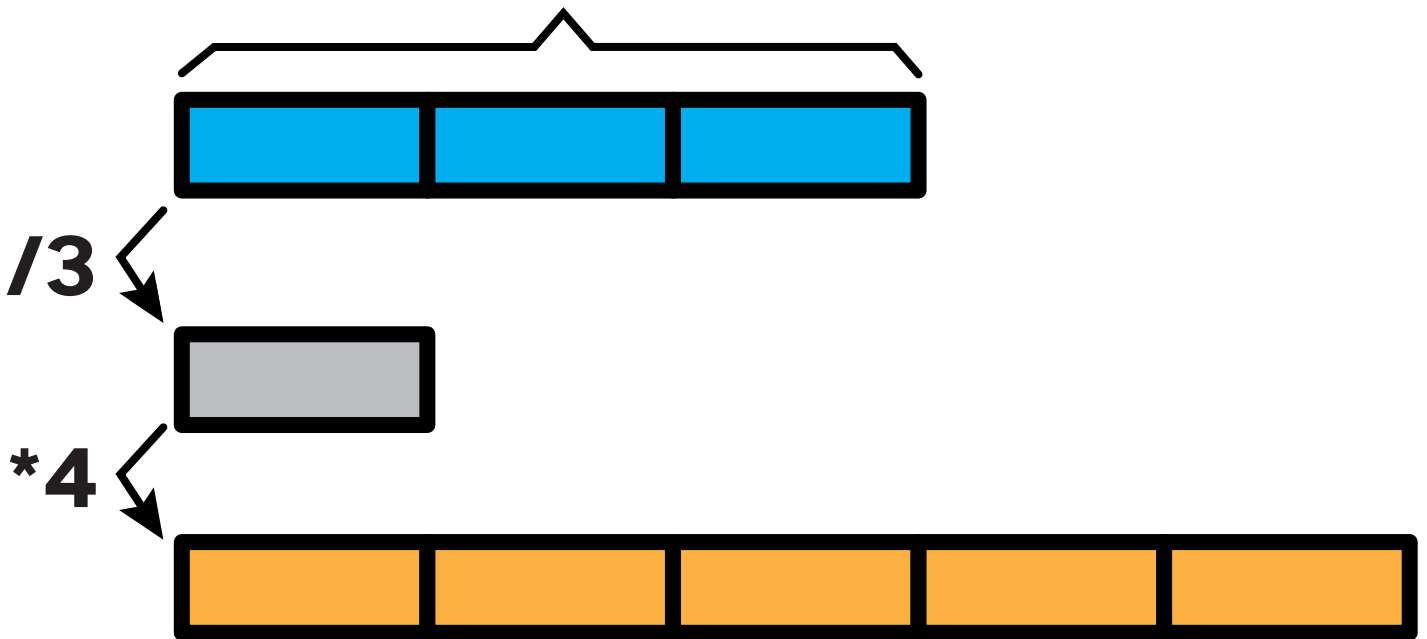

8,76 EUR

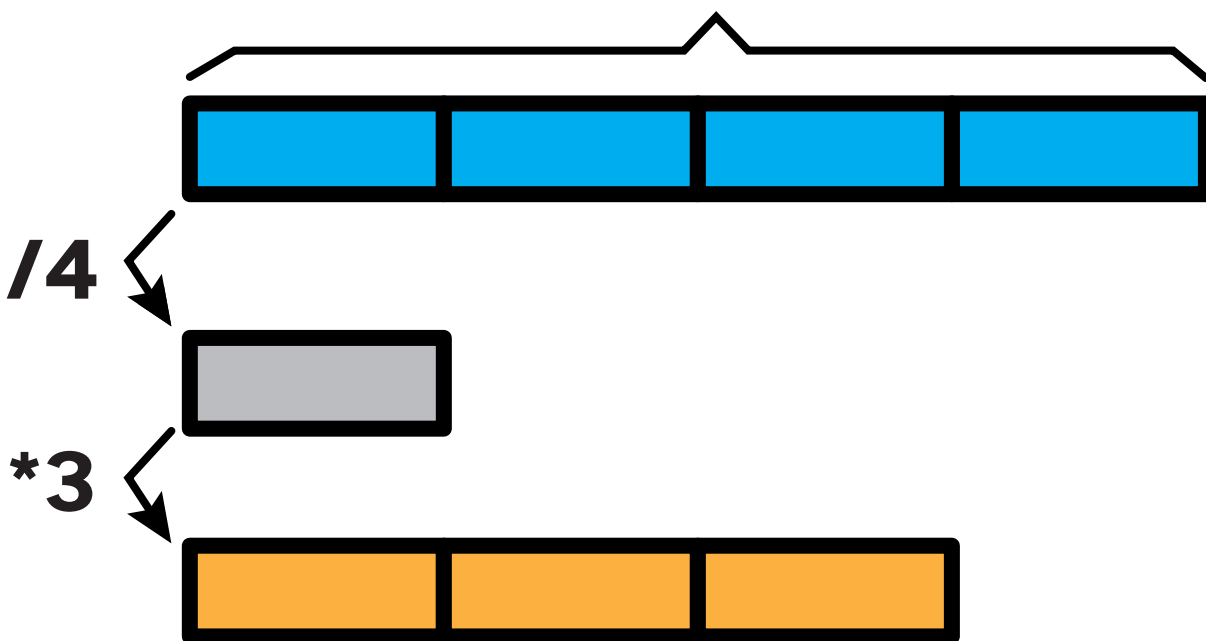

Plus2

S.106 415

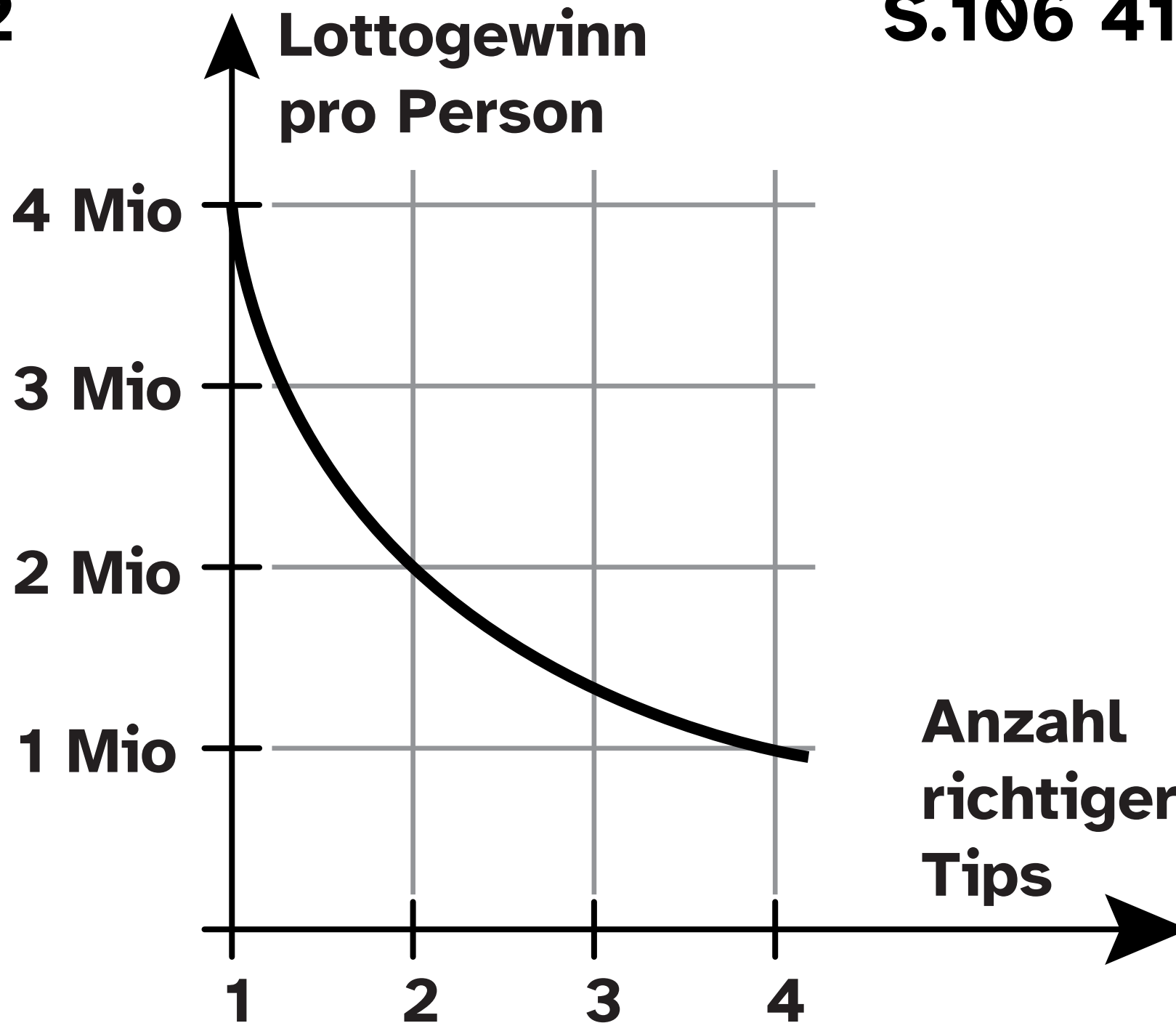
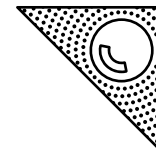

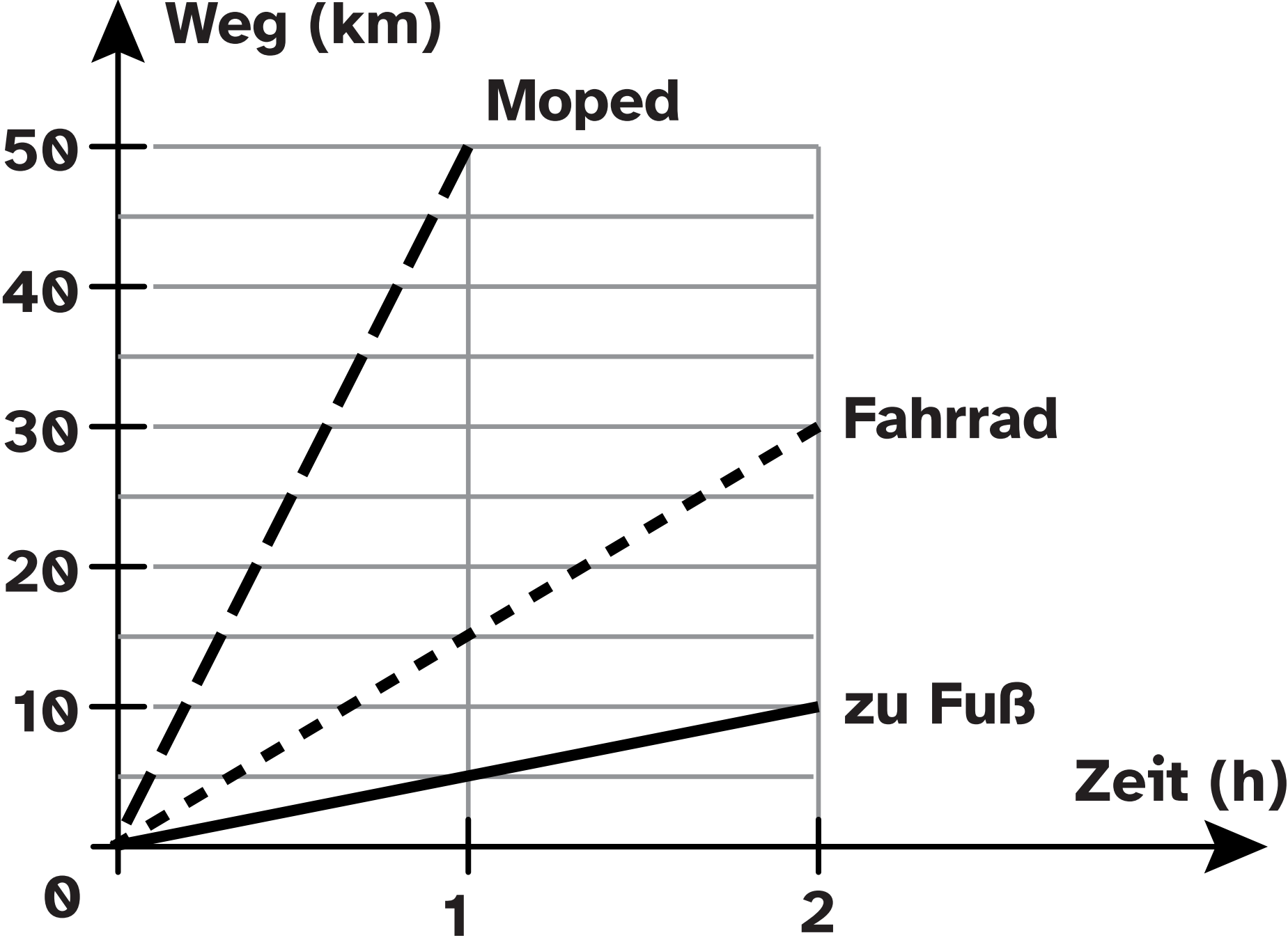
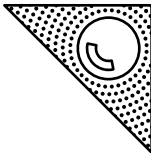

Plus2

S.109 422

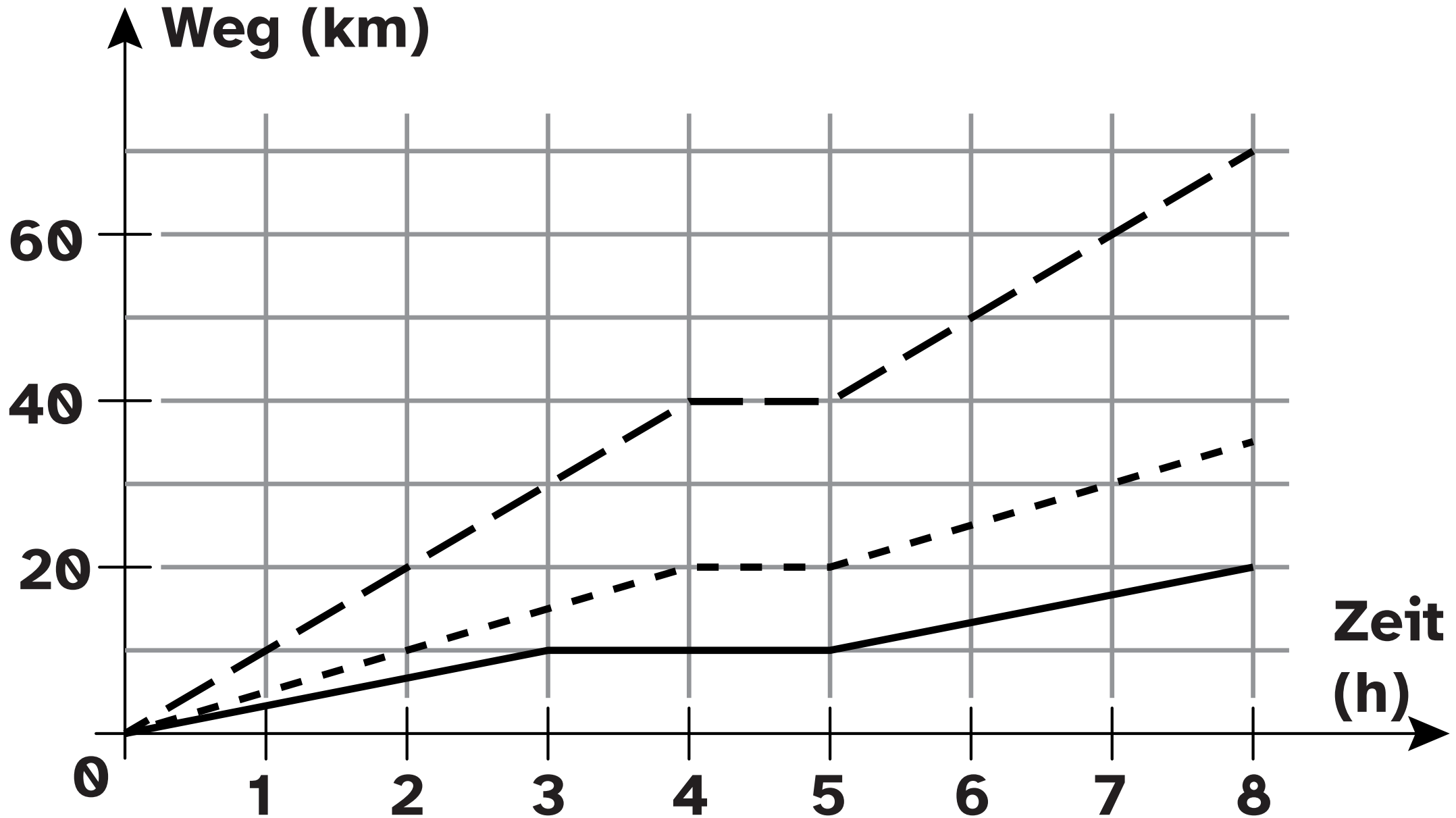
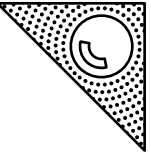

Plus2

S.109 428

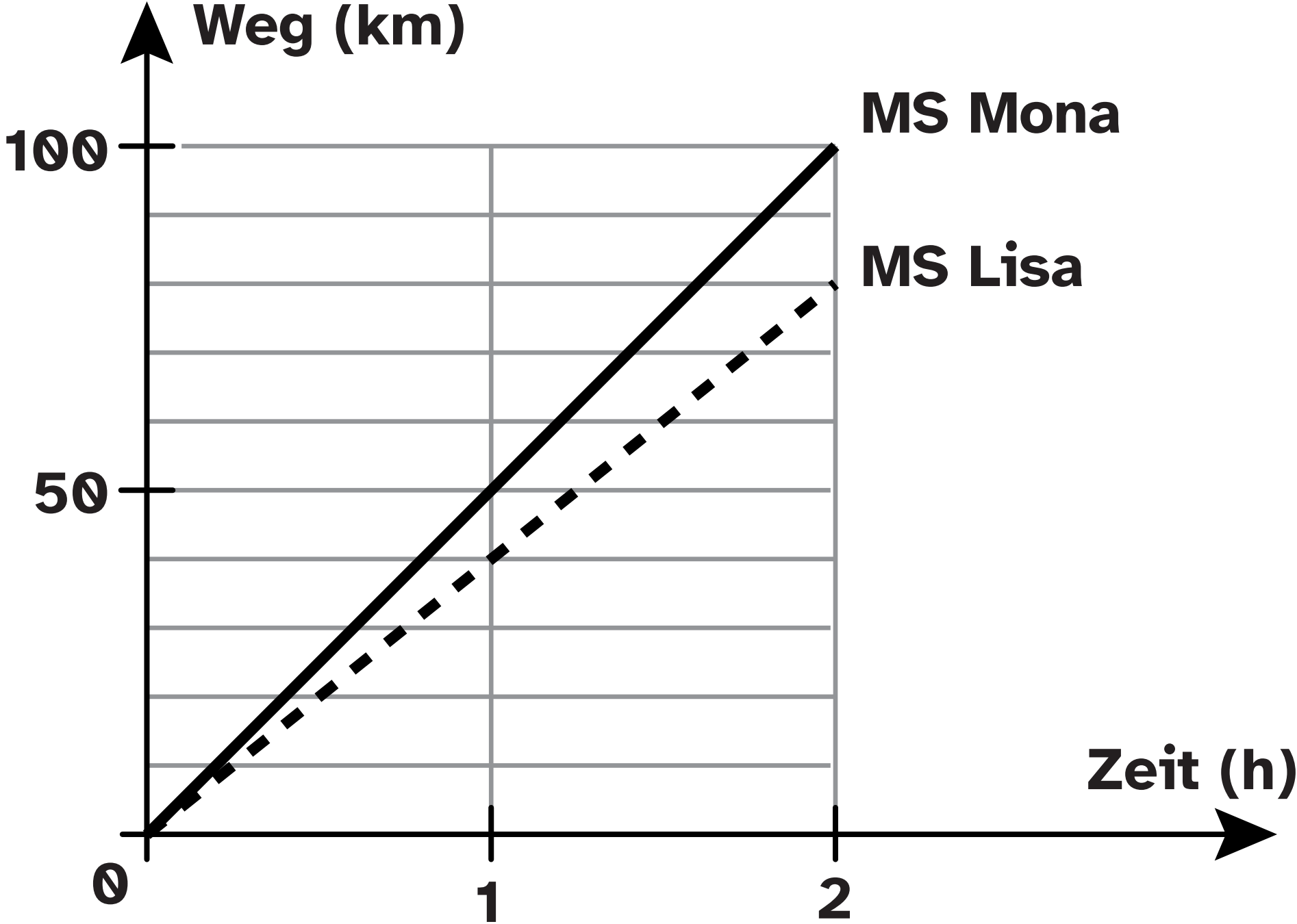
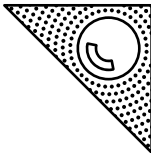

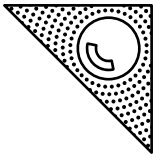

Plus 2

Teil 2, Seiten 128-158

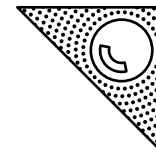

1 cm

a)

b)

c)

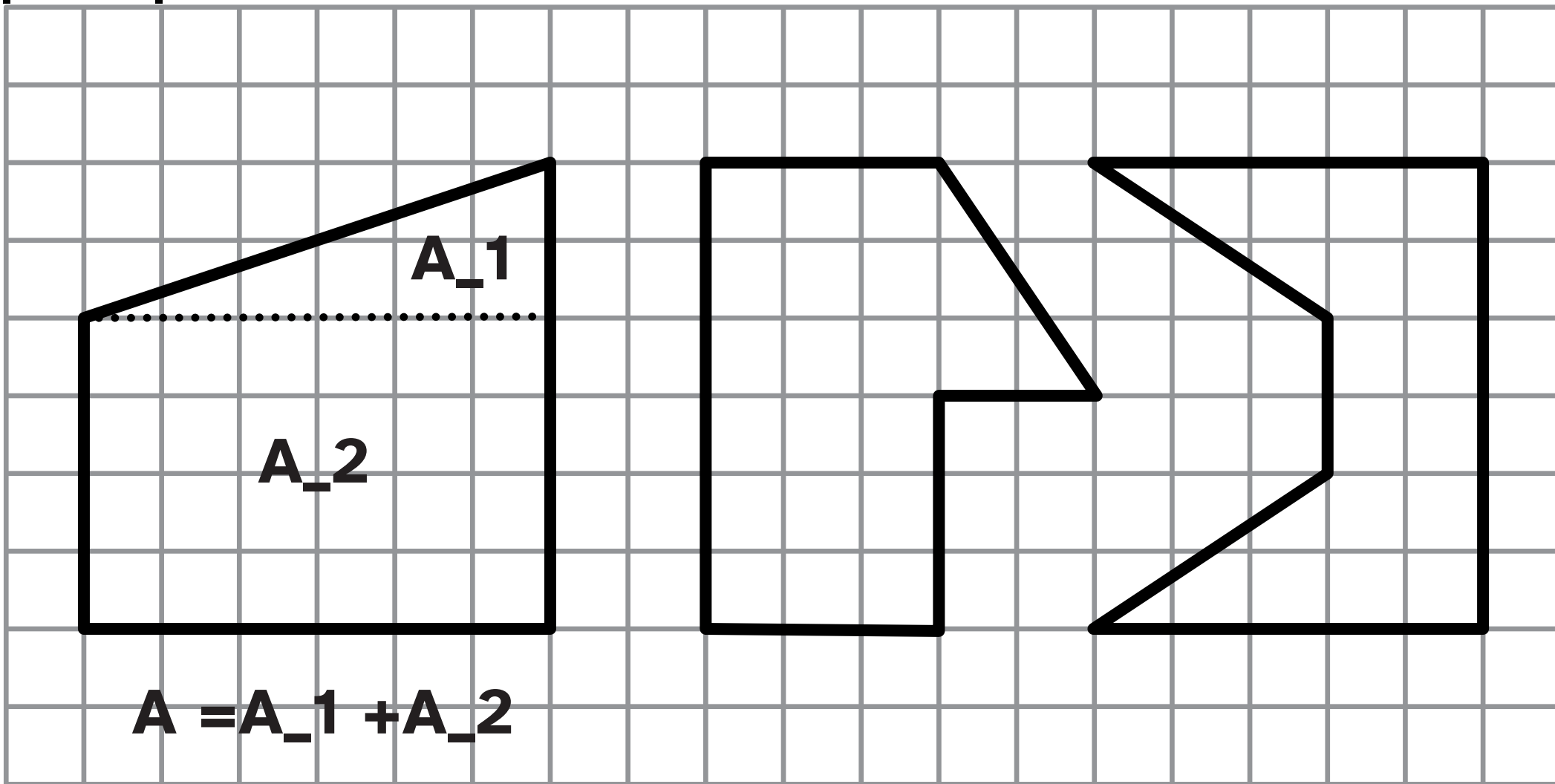

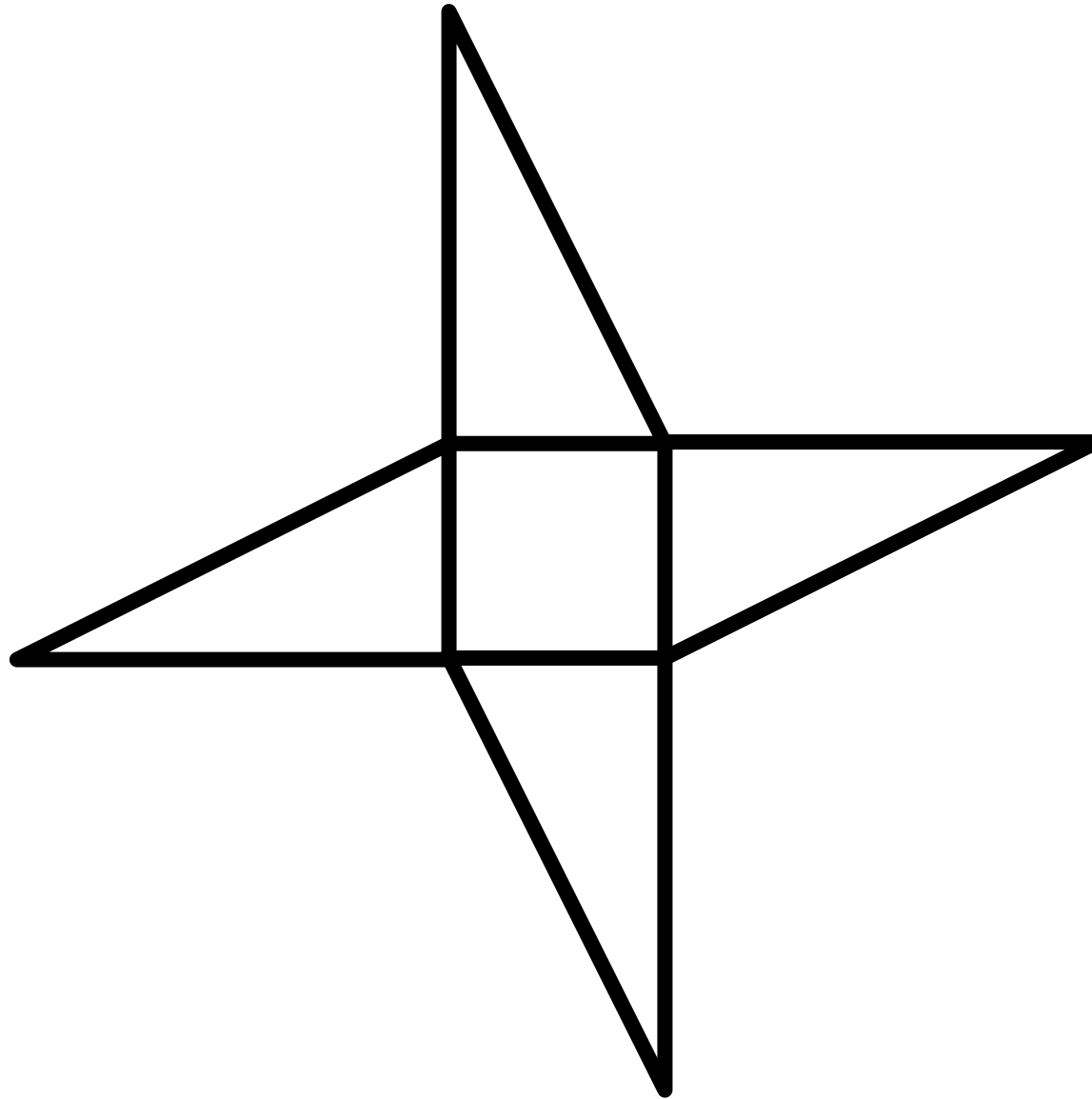
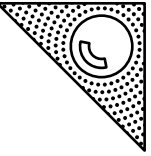

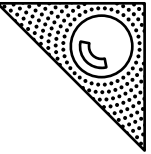

1 cm

a)

b)

c)

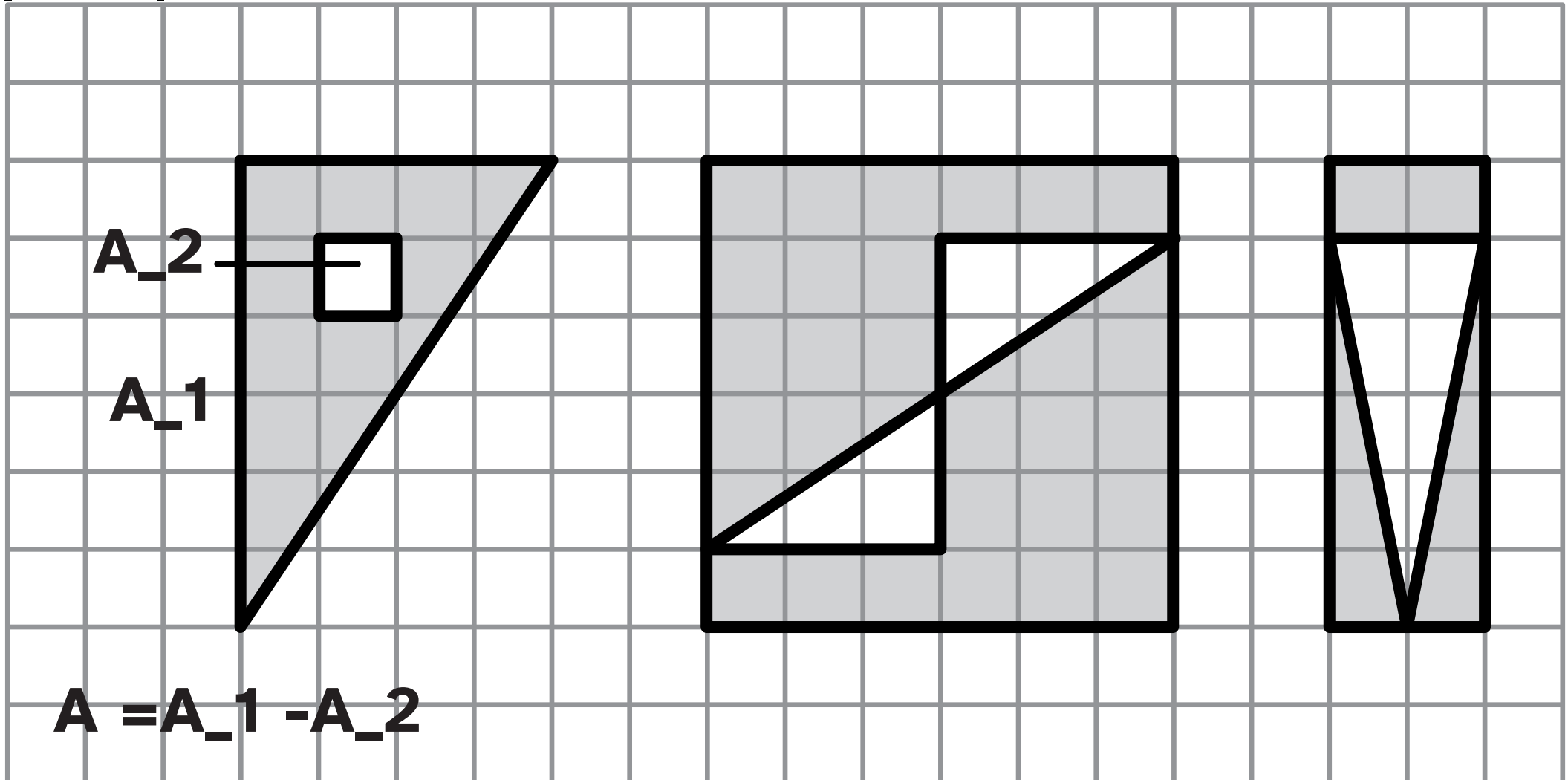

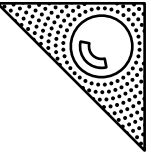

1 cm

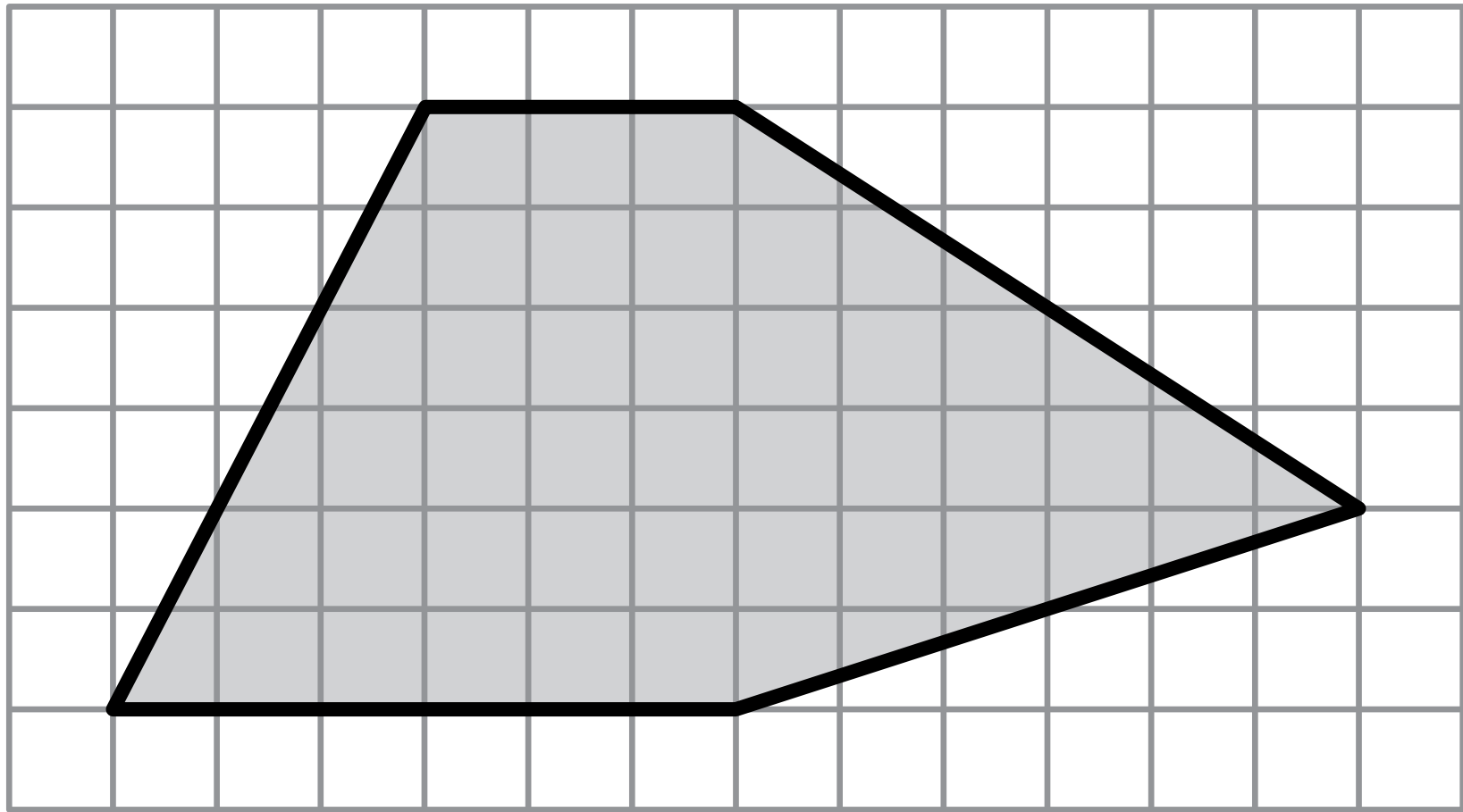

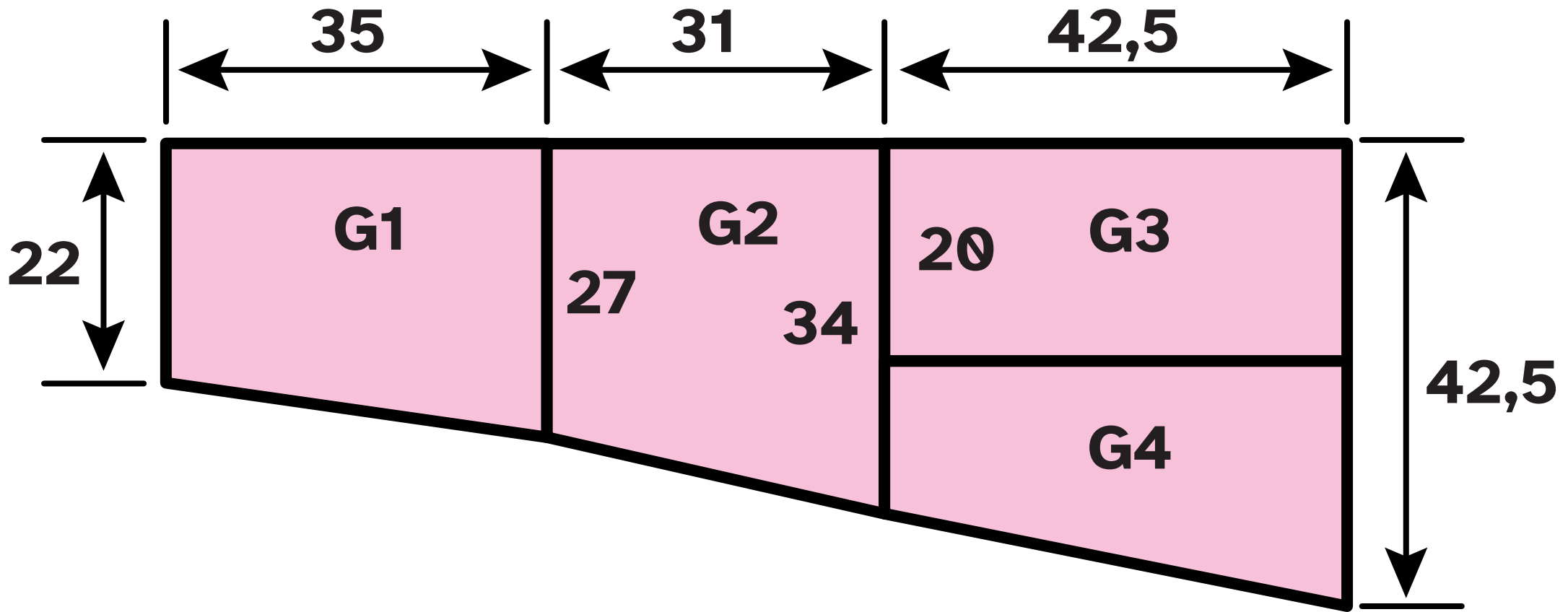
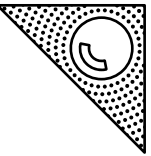

Plus2

S.132 528

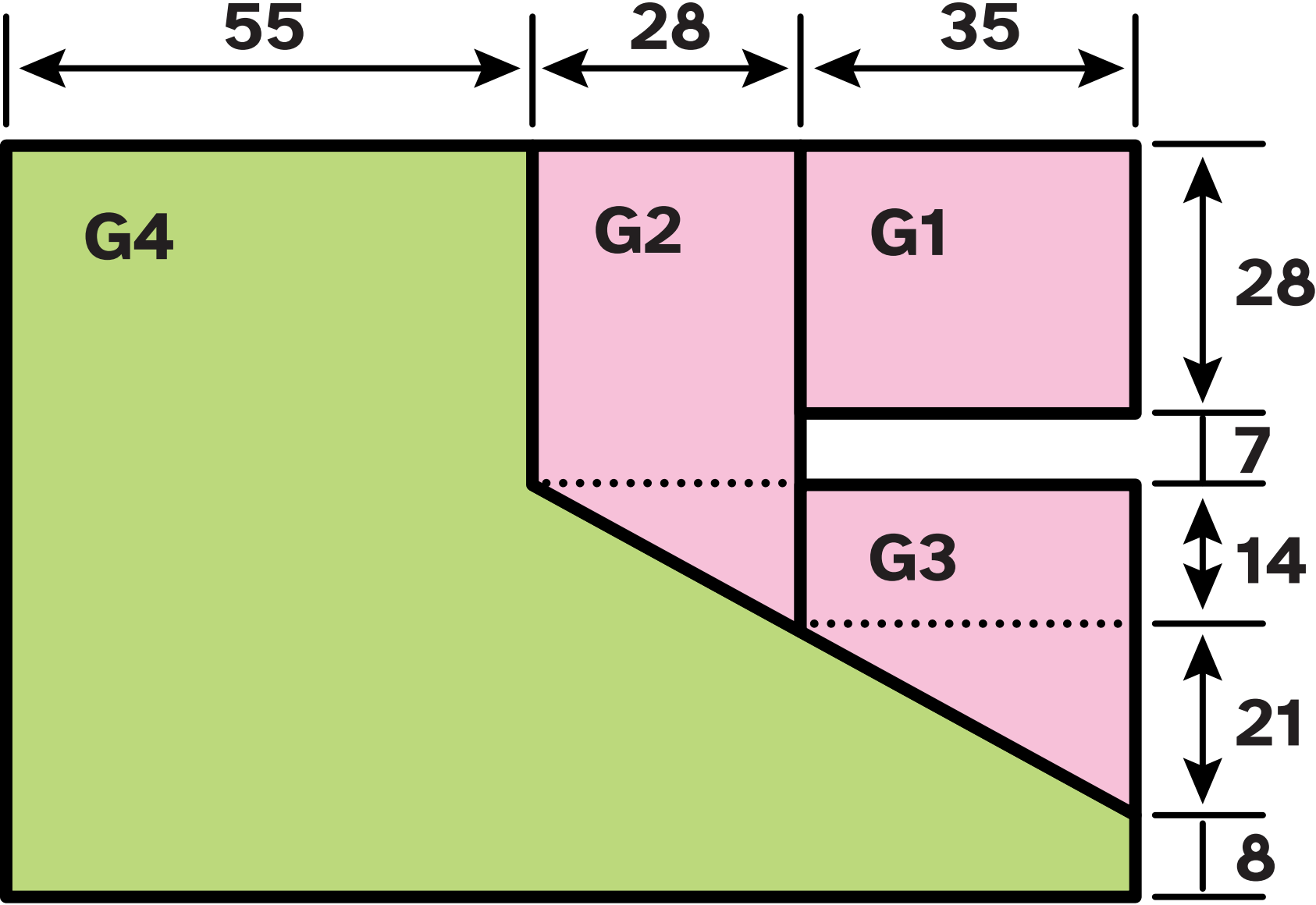
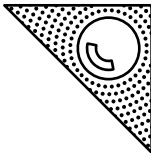

Plus2

S.133 530

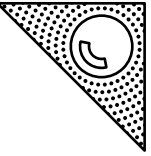

a)

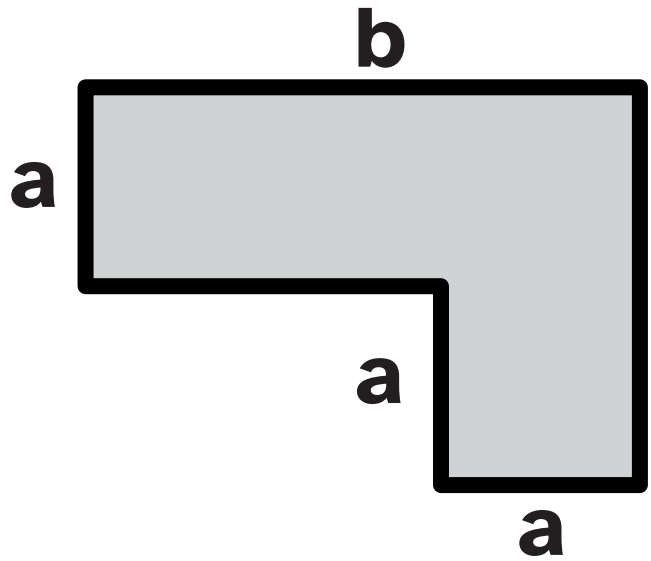

b)

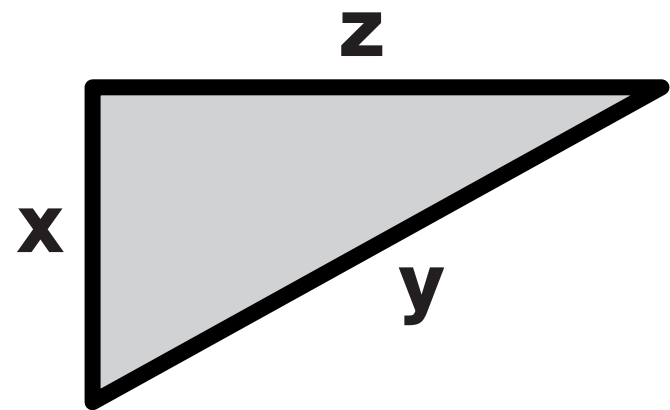

c)

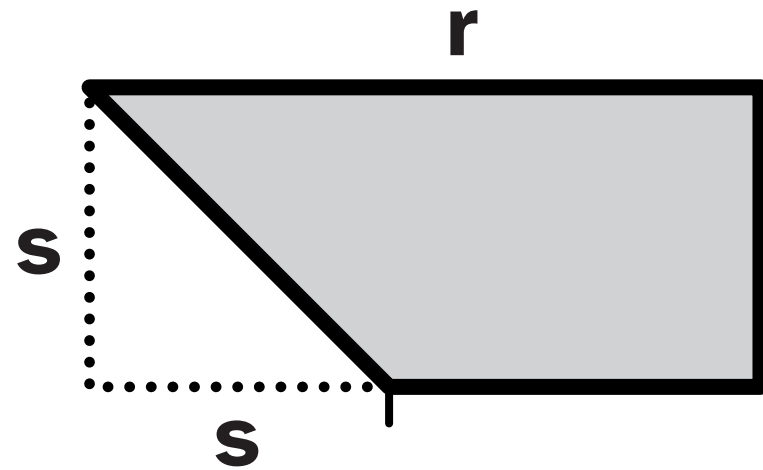

d)

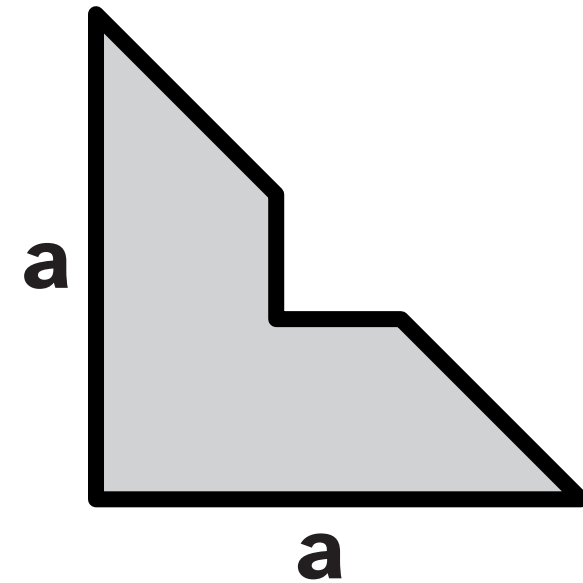

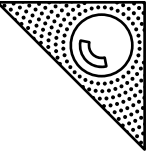

a)

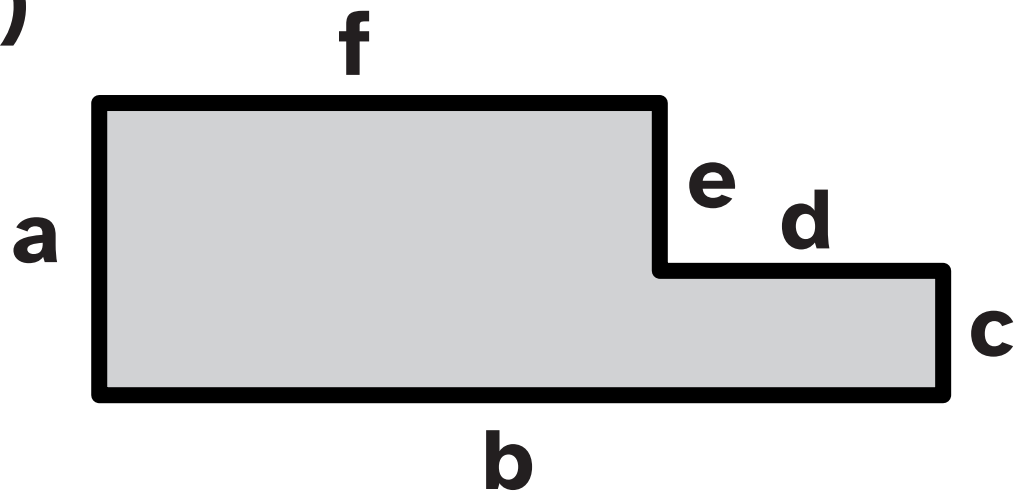

b)

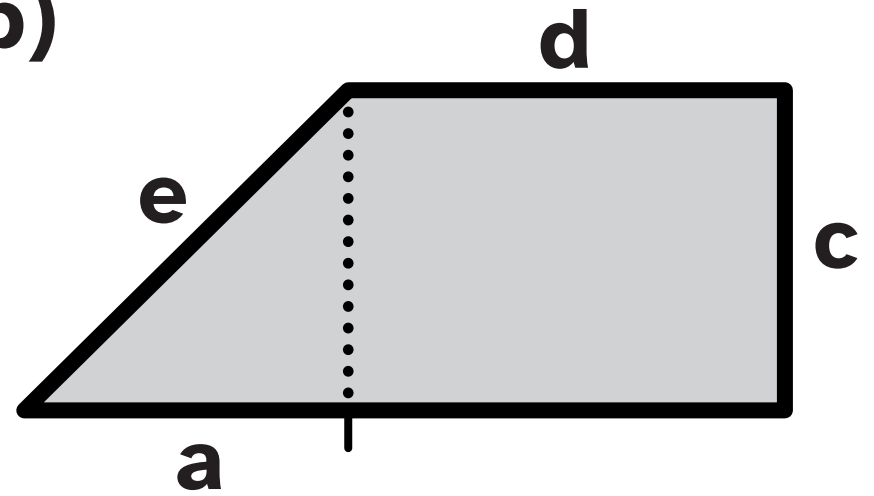

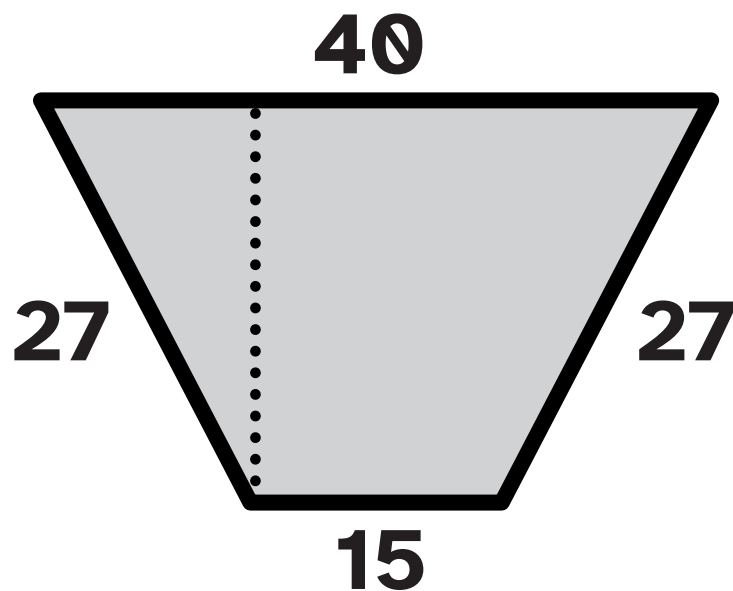
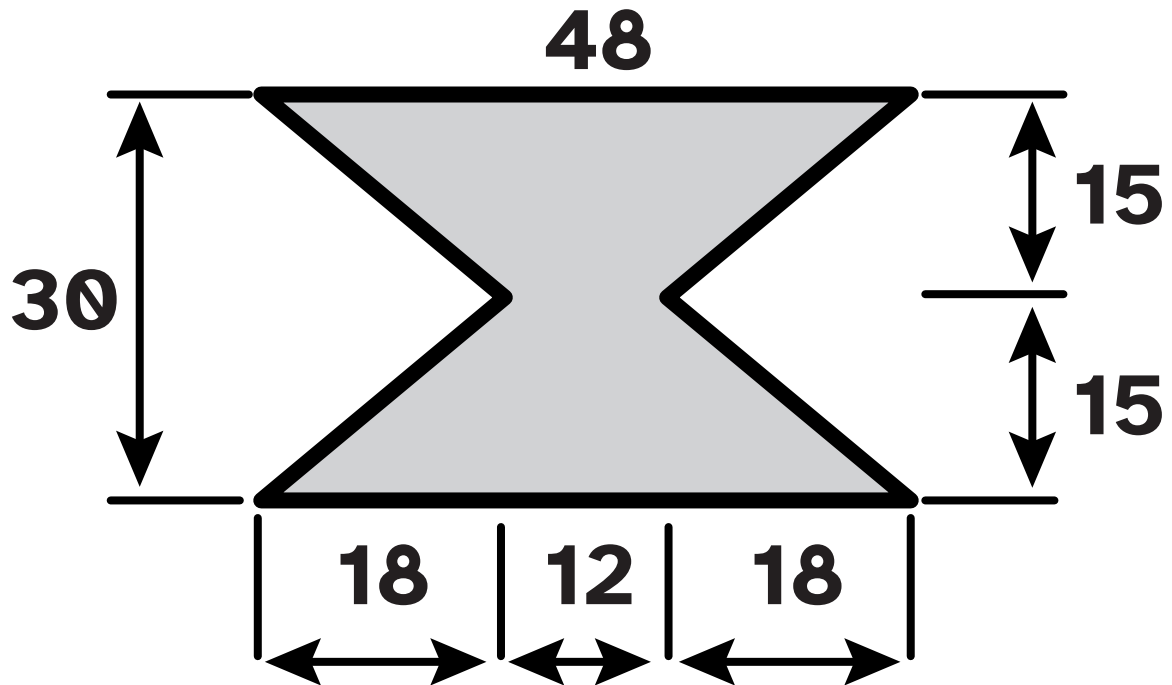
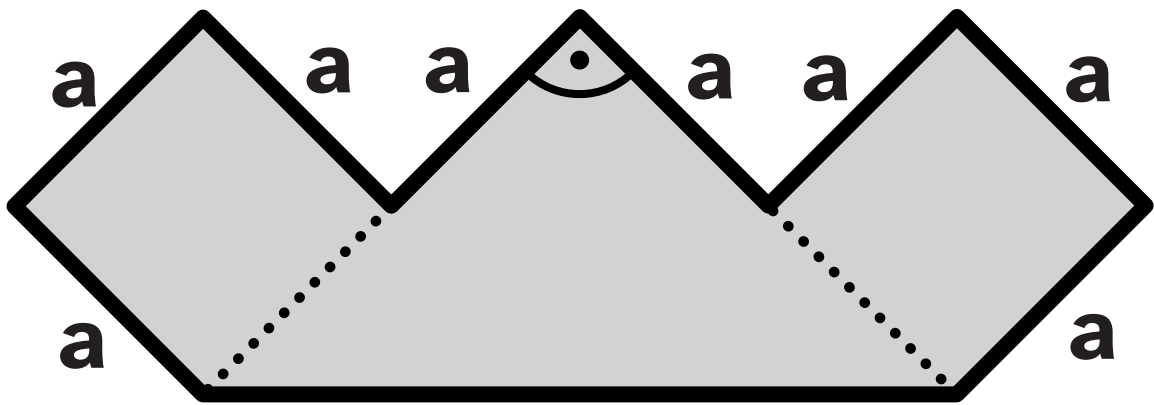
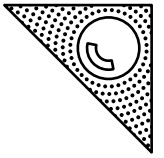

Plus2

S.140 557

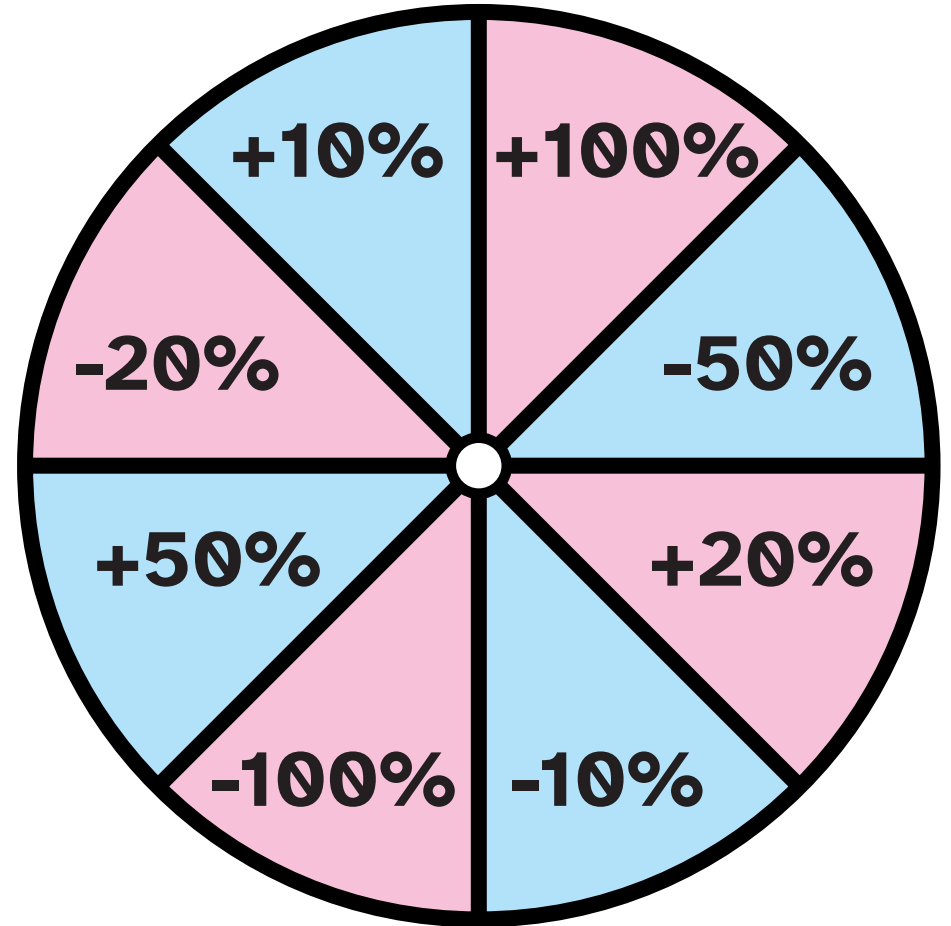
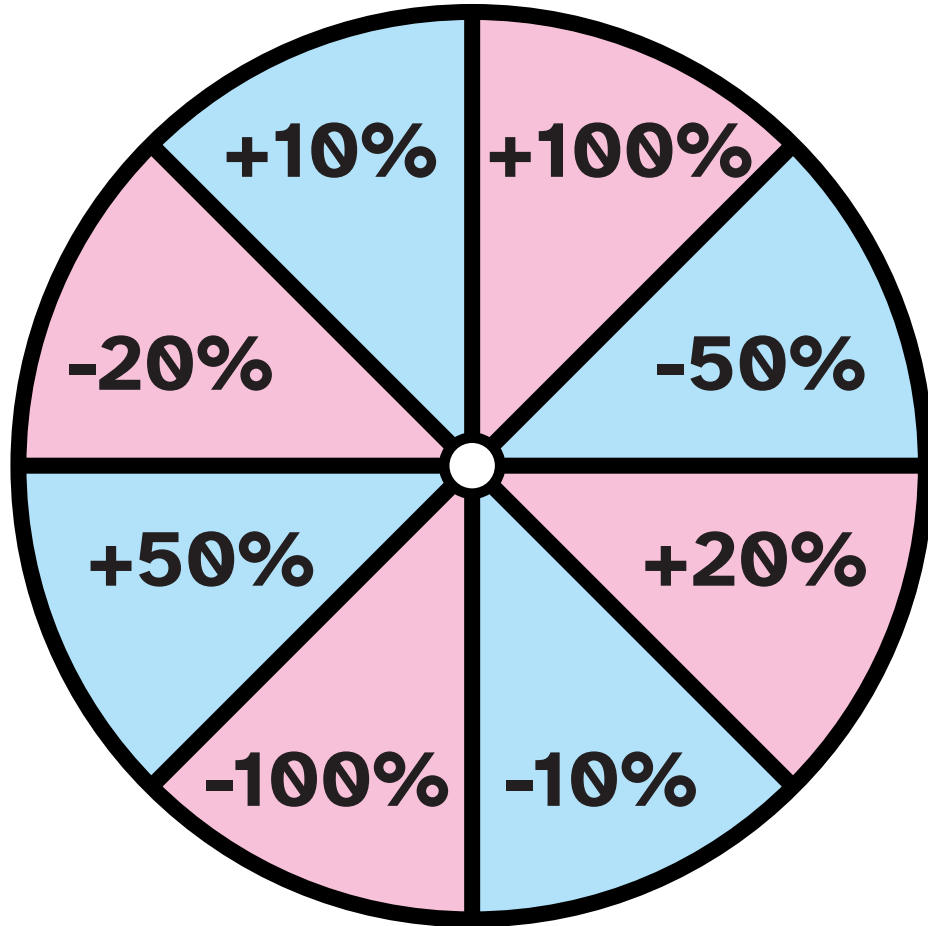
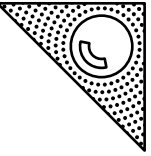

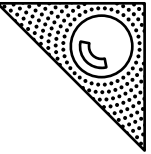

Besucherzahlen März

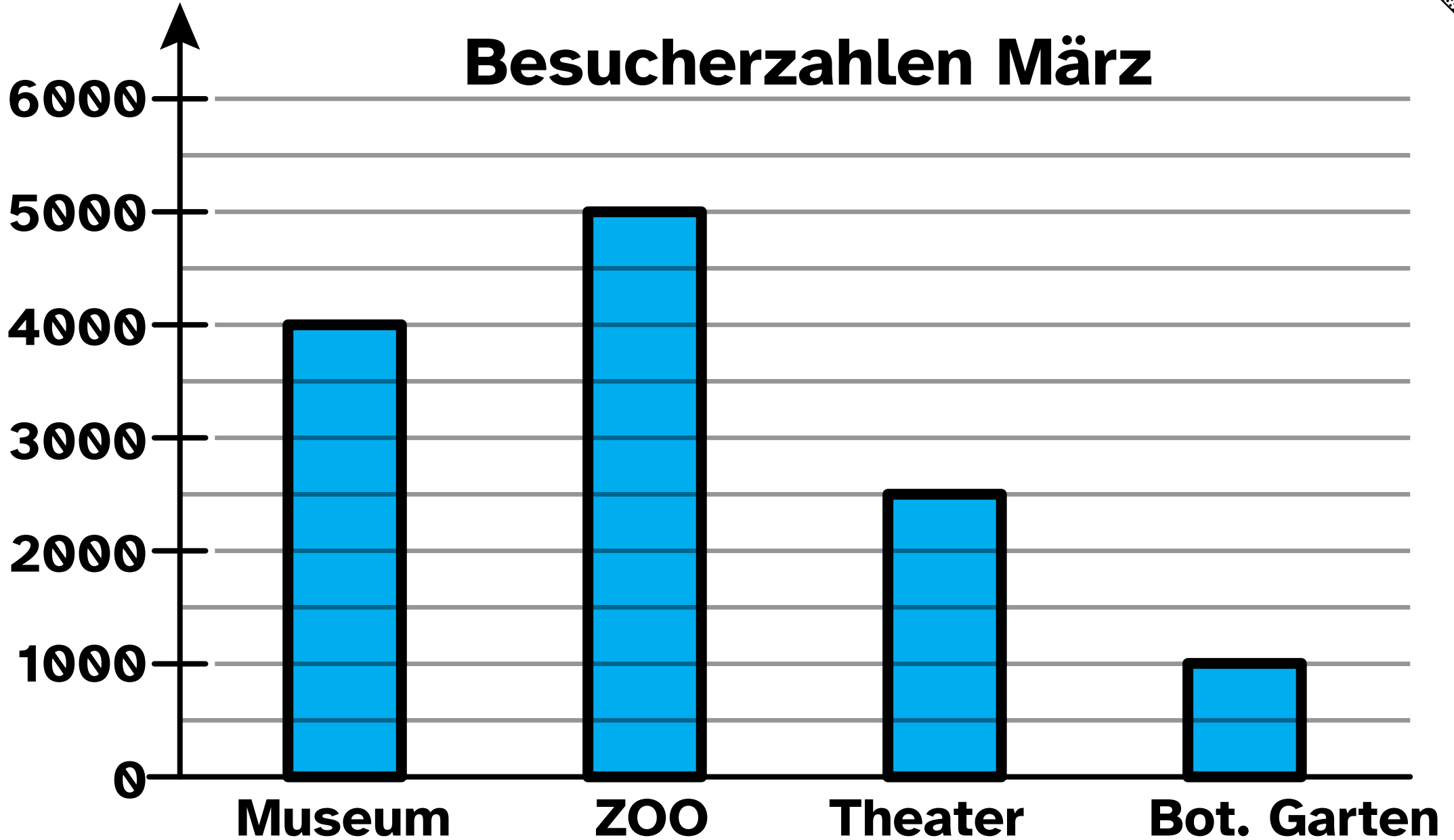

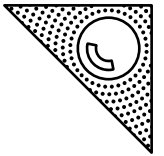

Anzahl der Sportunfälle der 0- bis 14-Jährigen

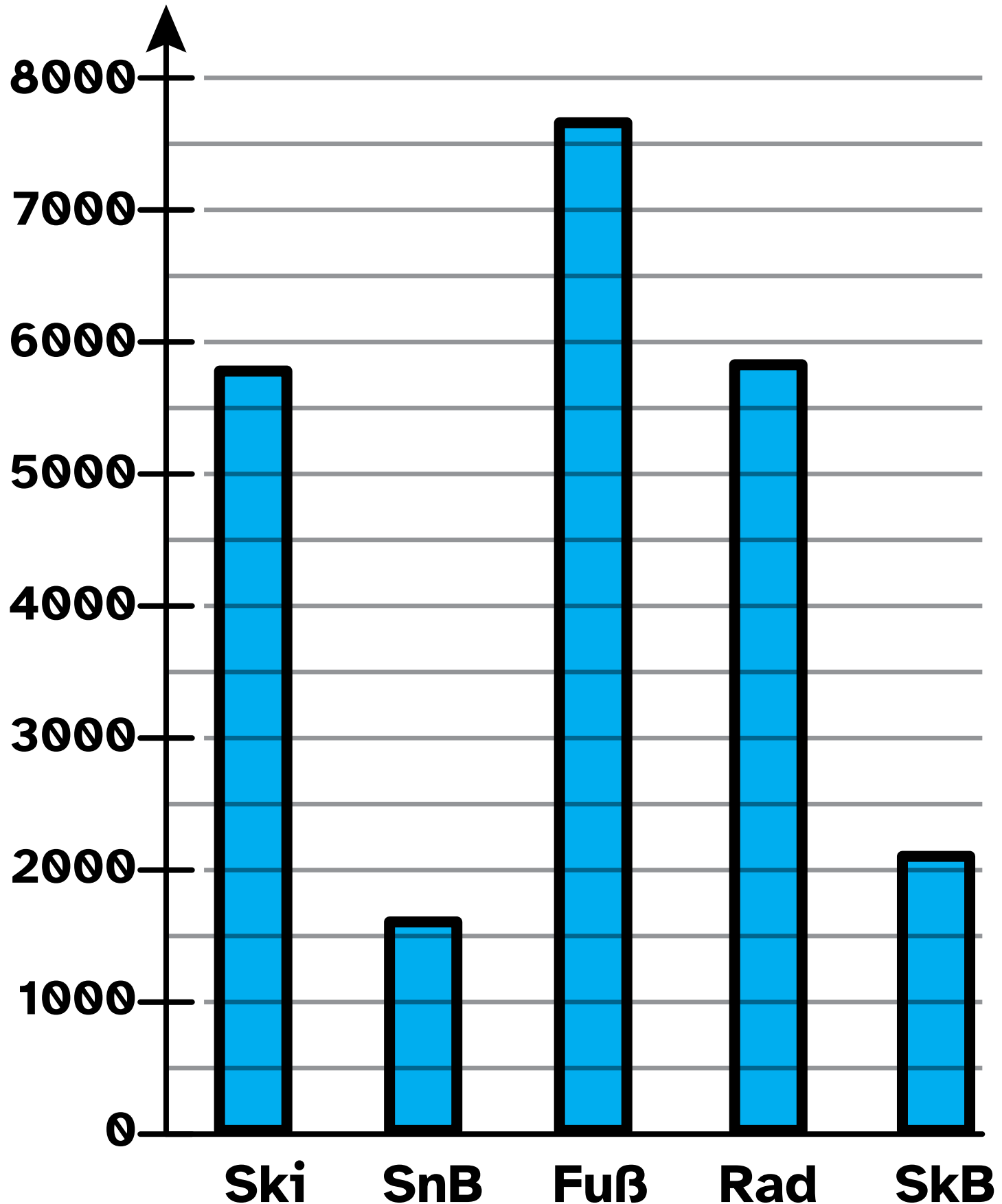

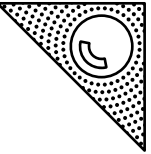

Verkaufszahlen Firma A

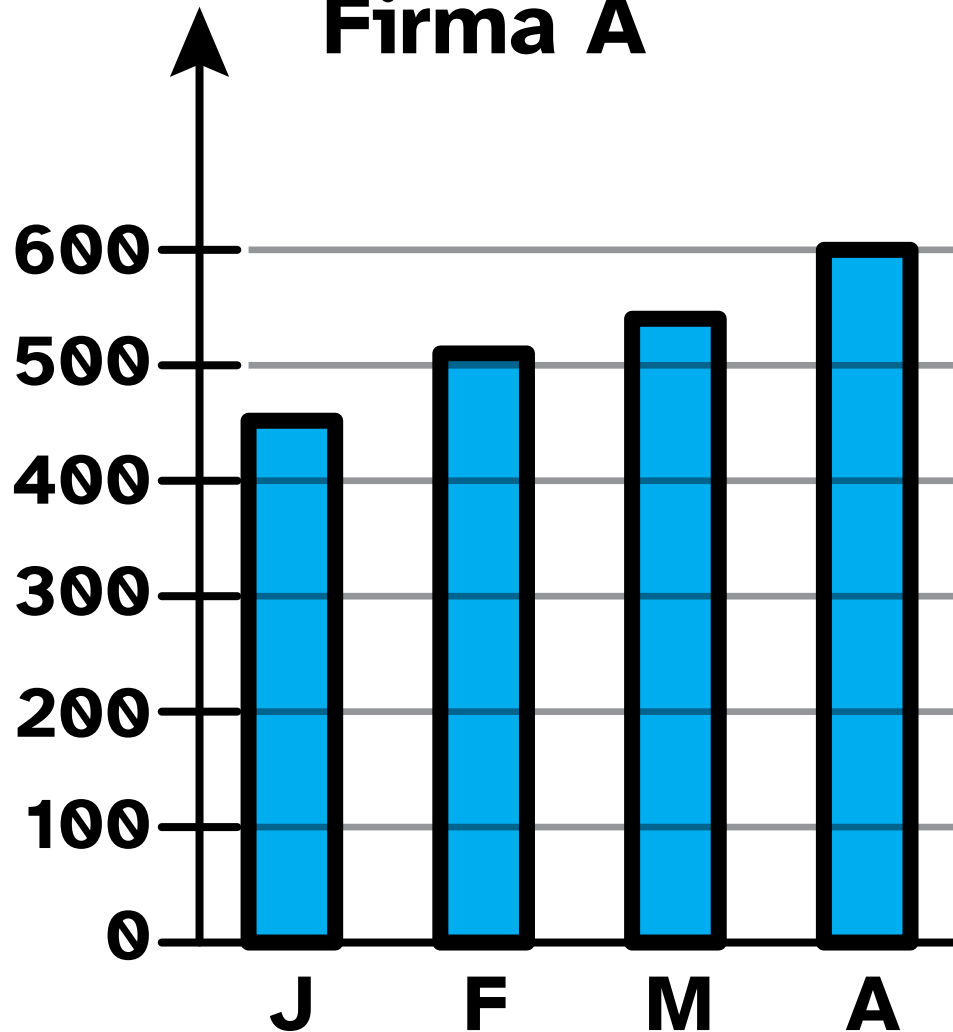

Verkaufszahlen Firma B

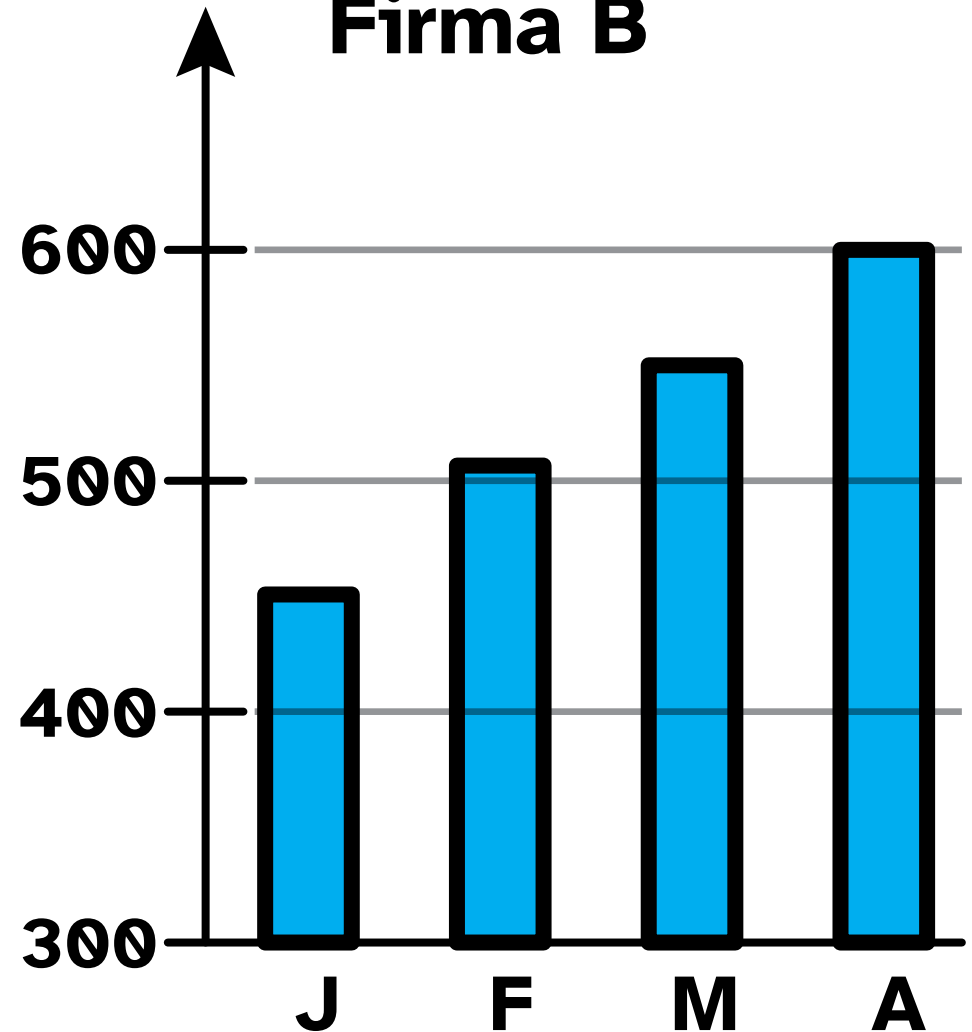

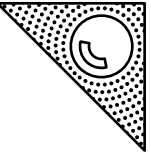

Diagram A
Einwohnerzahl

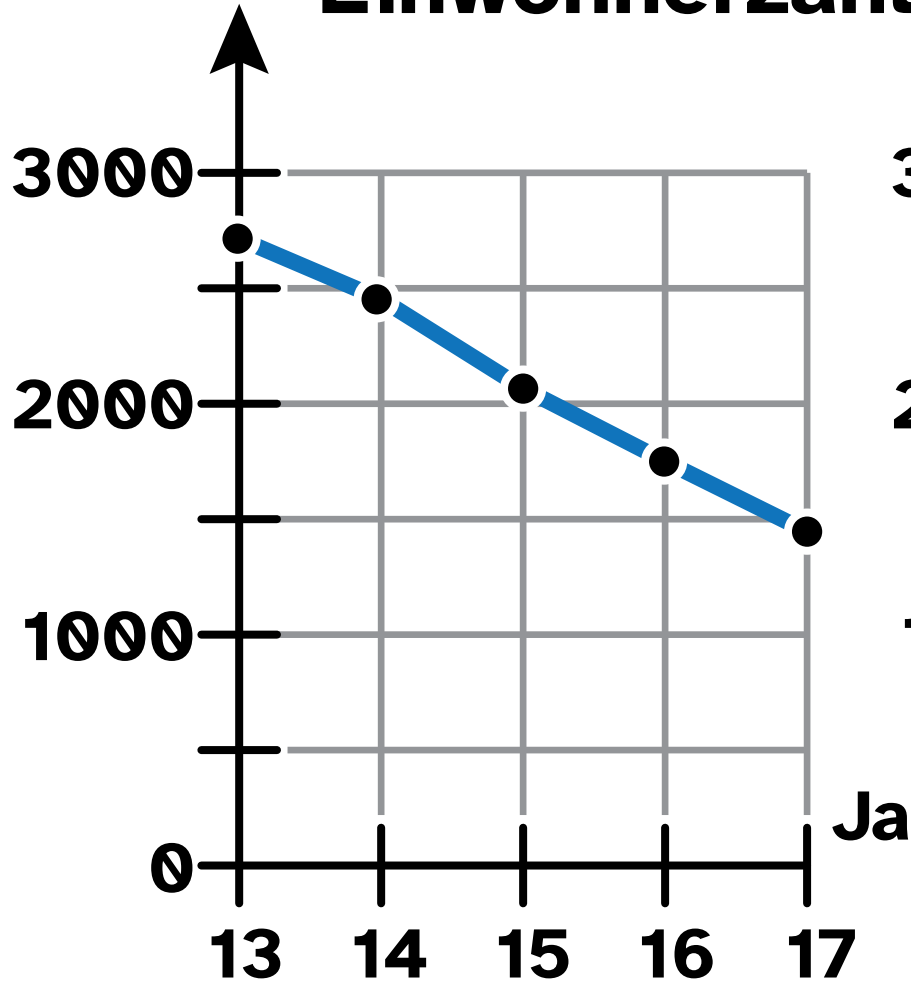
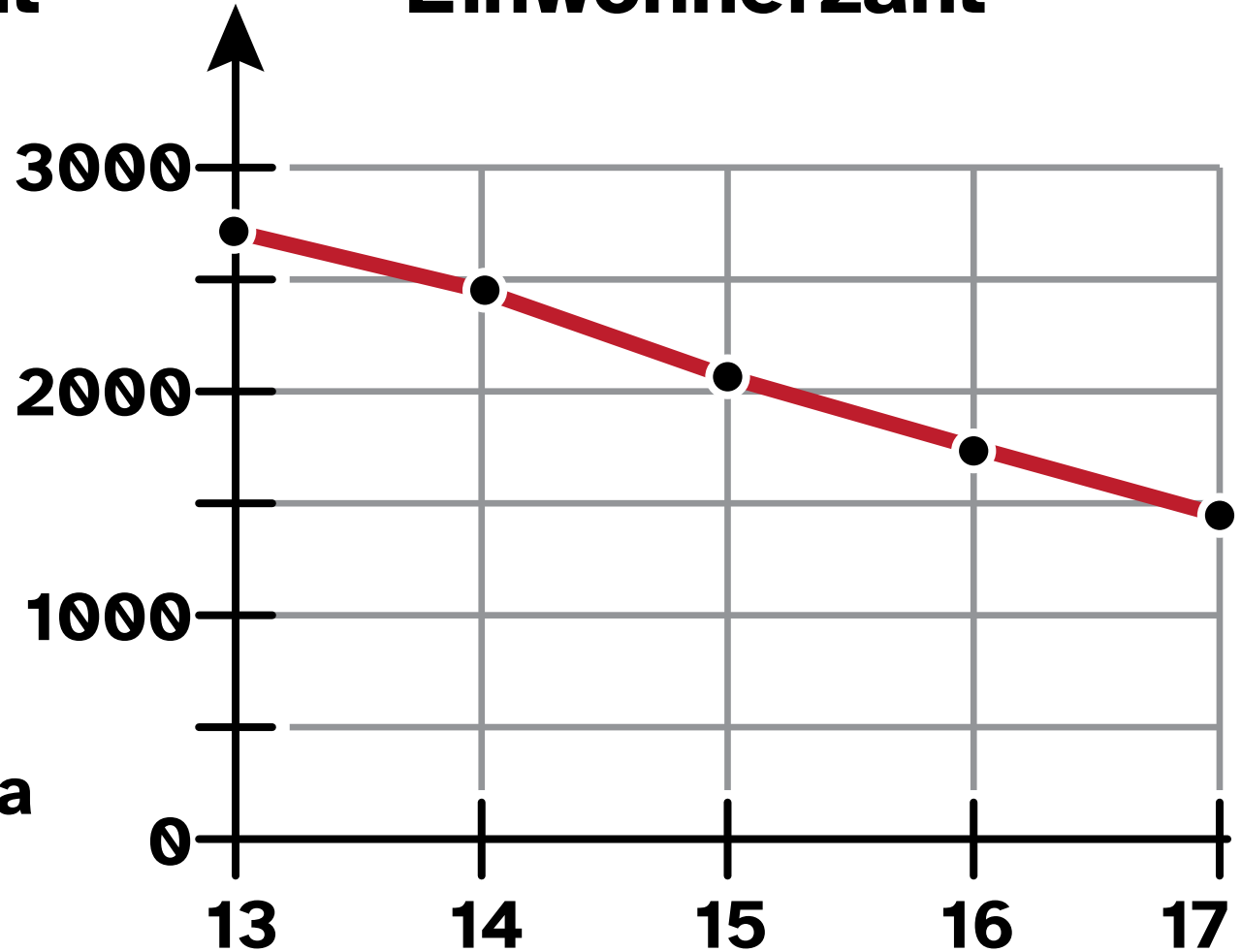
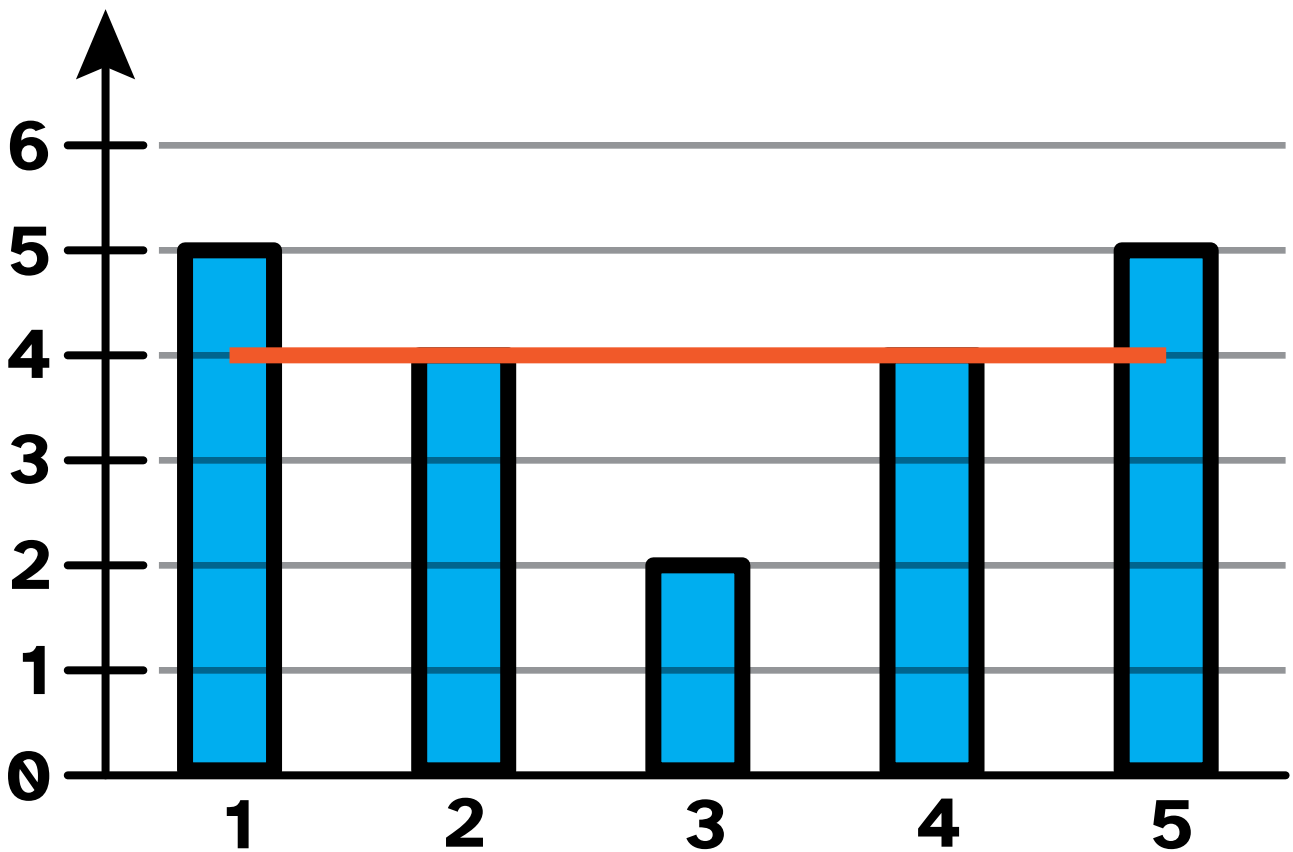
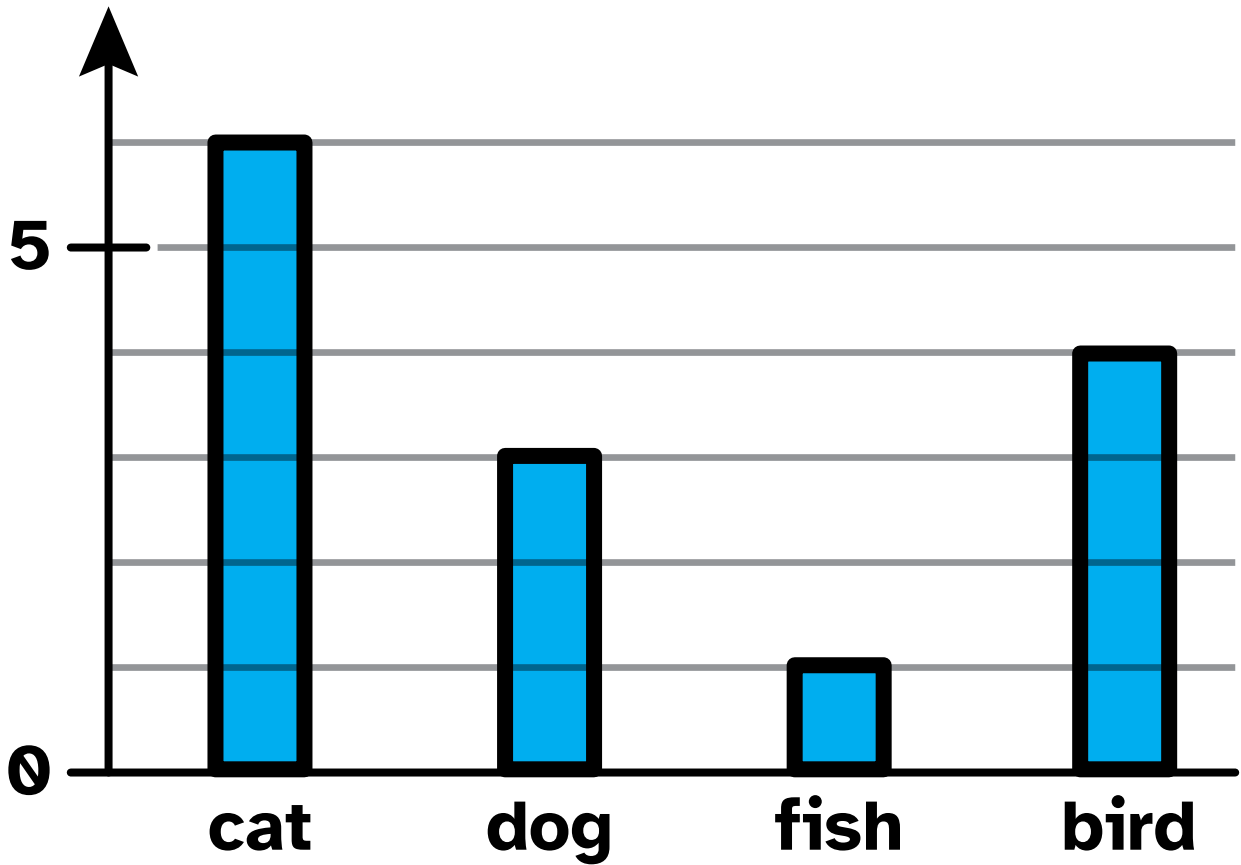
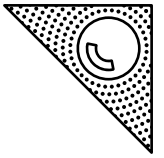

Diagram B
Einwohnerzahl





Plus2

S.155 614

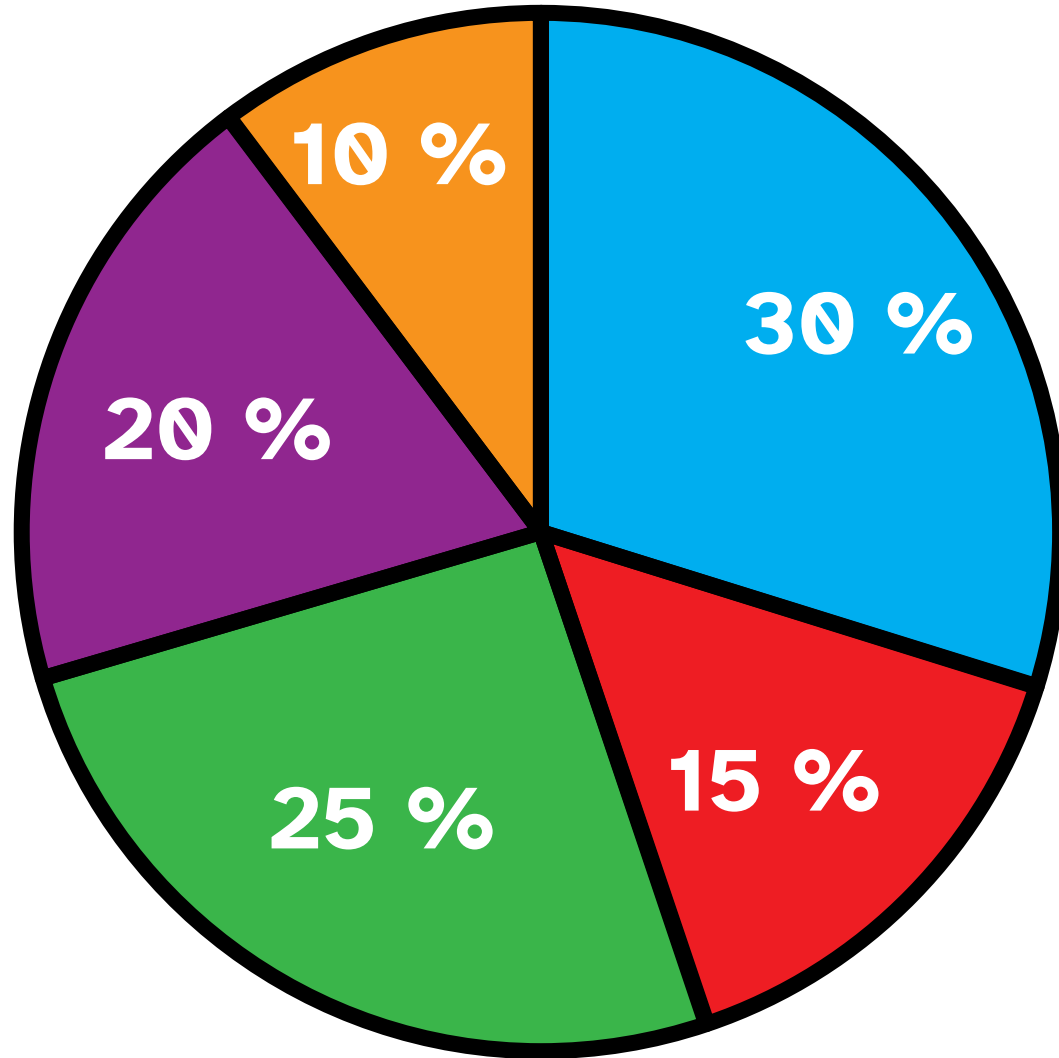
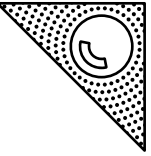

Crispy



Honig



Milch



Nuss



Traube

Plus2

S.155 616

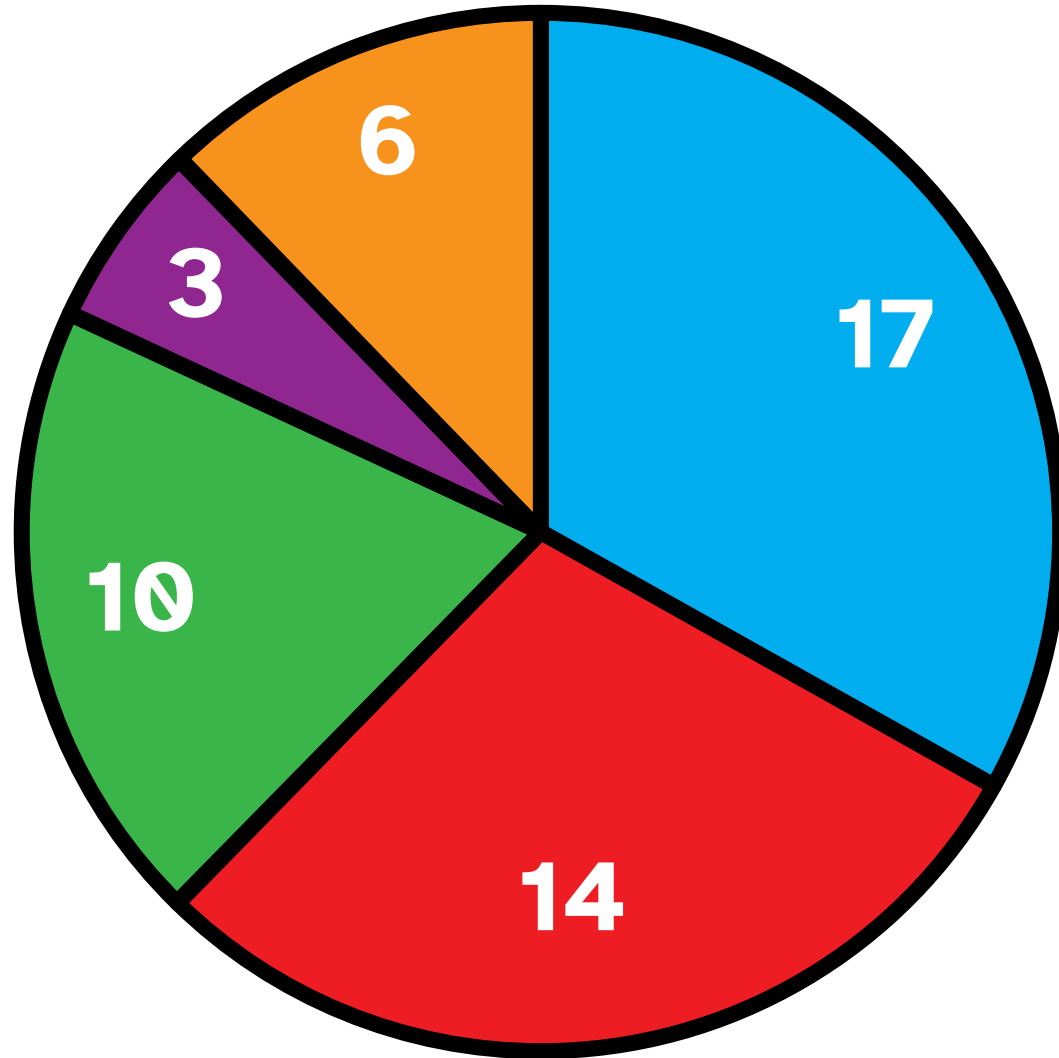
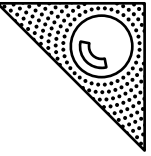

Schoko



Erdbeer



Vanille



Apfel



Joghurt

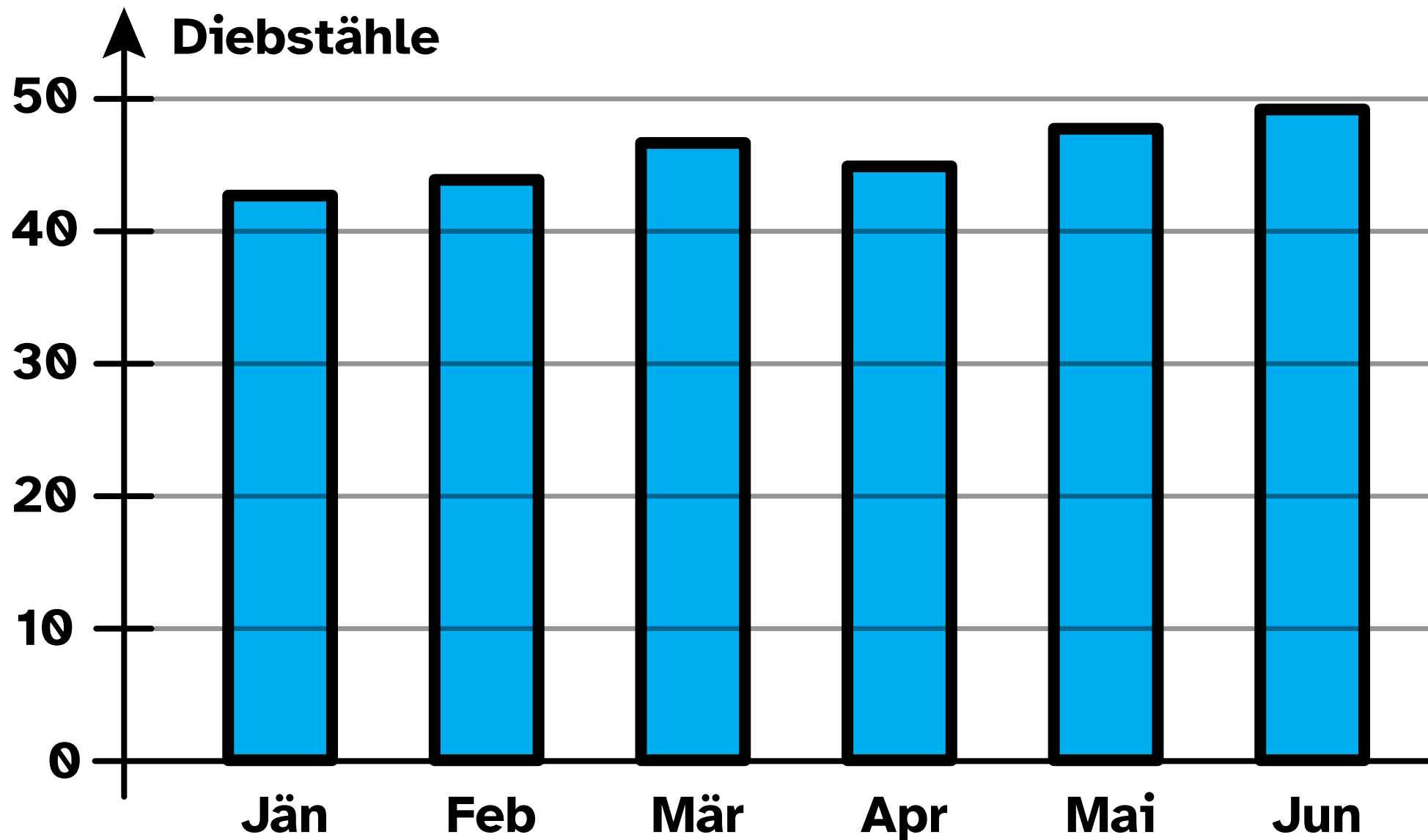
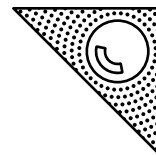

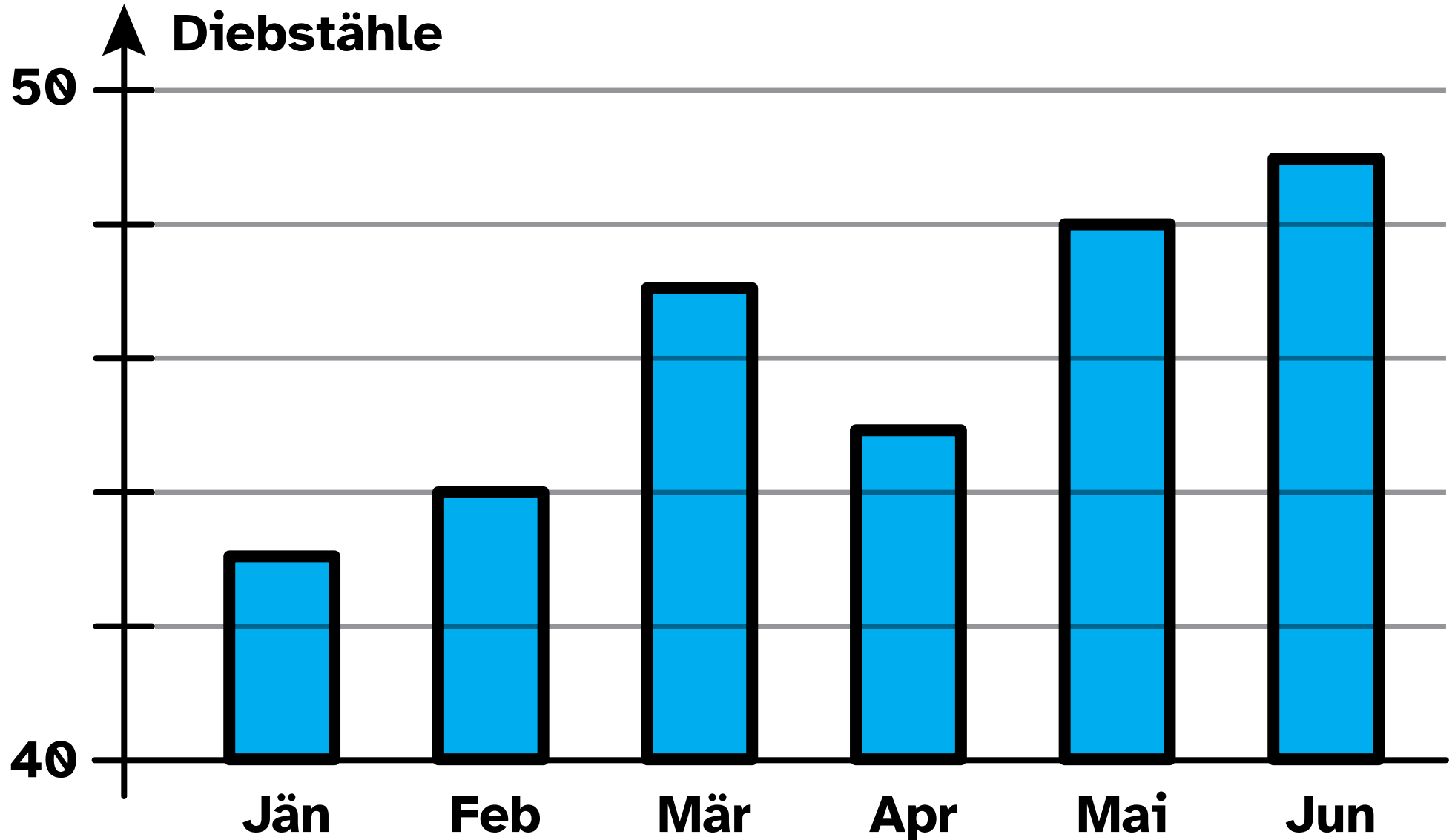
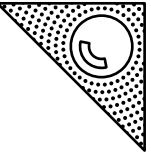

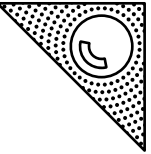

a)

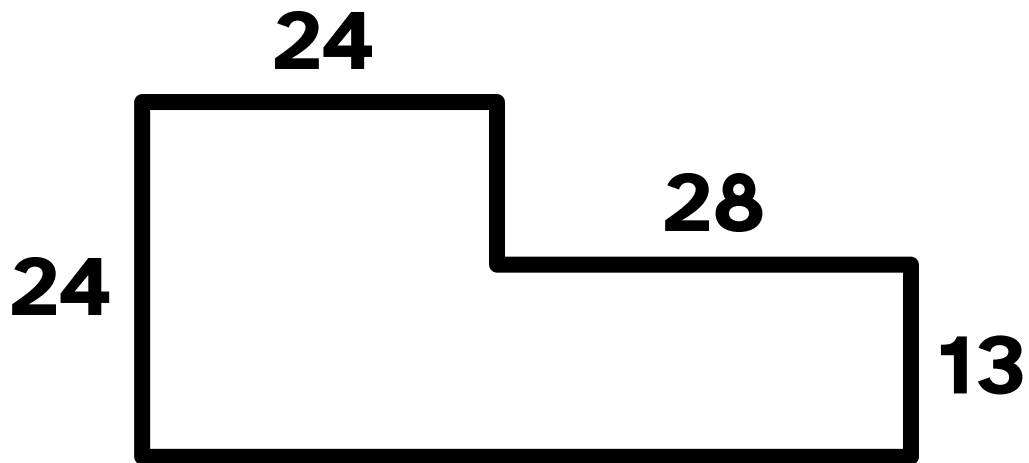

b)

