



**Vergrößerte und aufbereitete Versionen
ausgewählter Grafiken aus dem Schulbuch**

Plus! 3



Grafiken: Tomáš Batha

Plus3

S. 54 220, 222

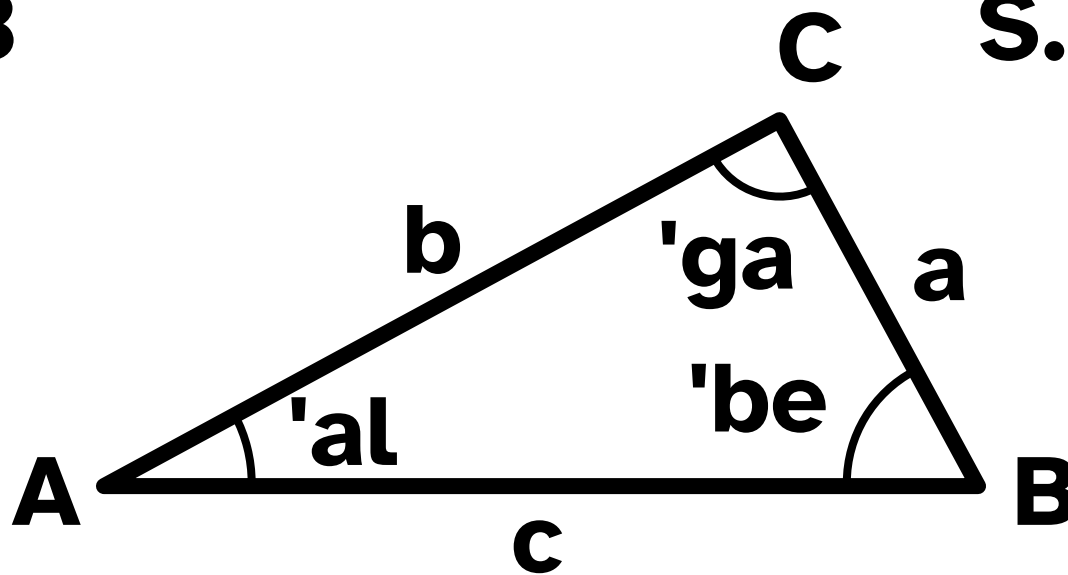
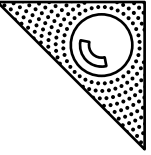

a)

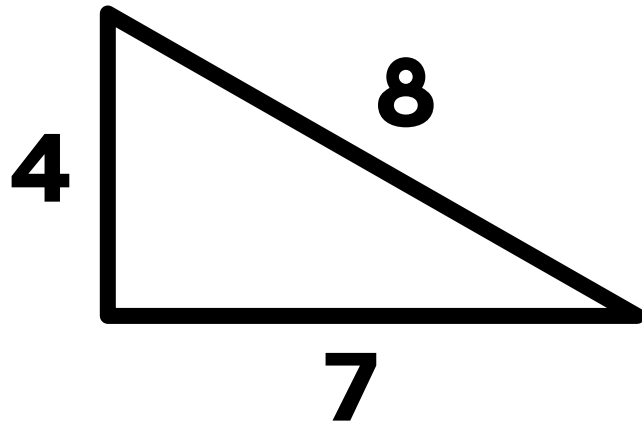

b)

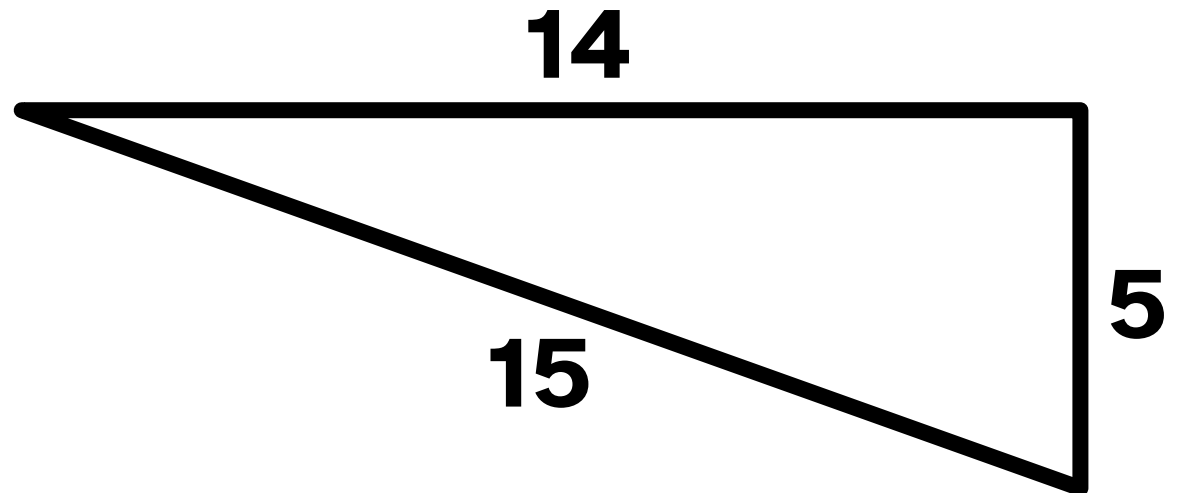

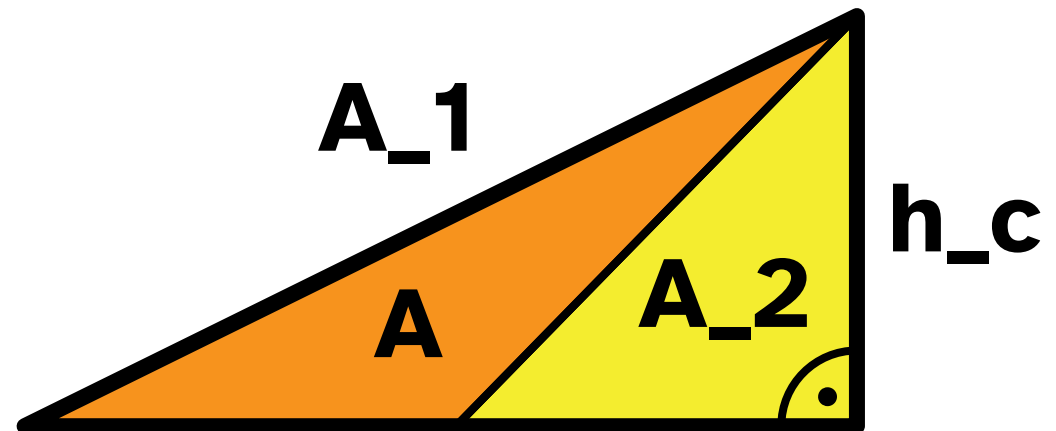
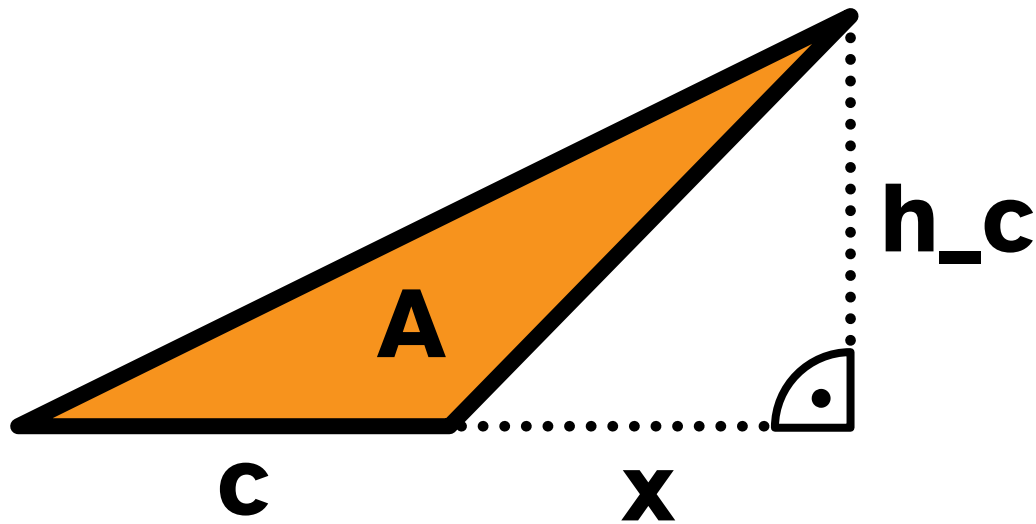
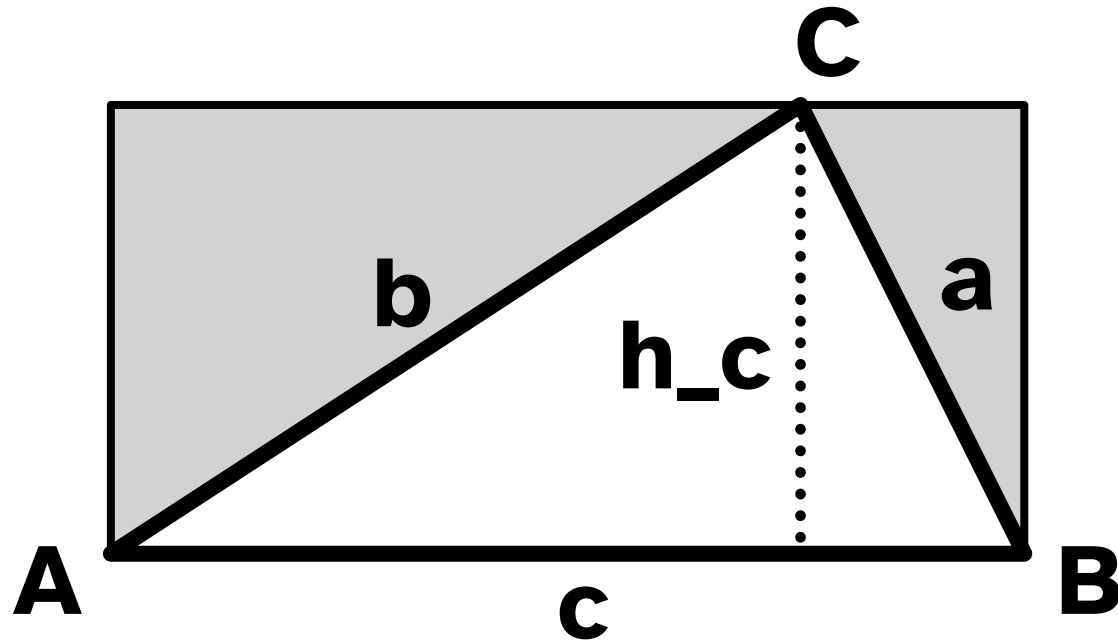
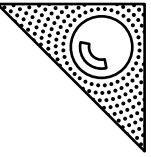

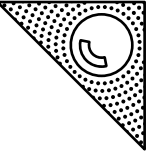

a)

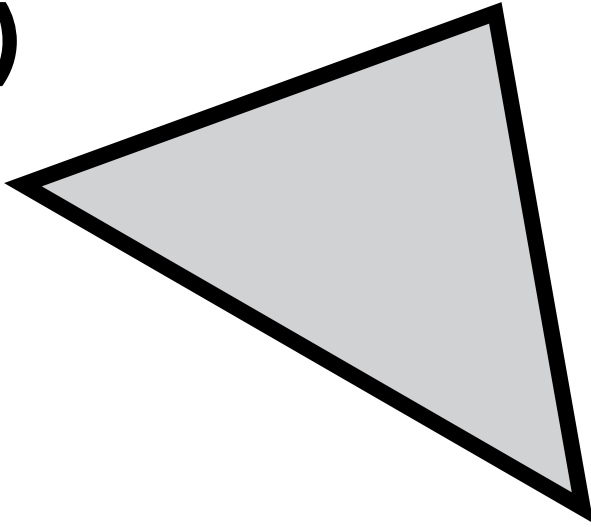

b)

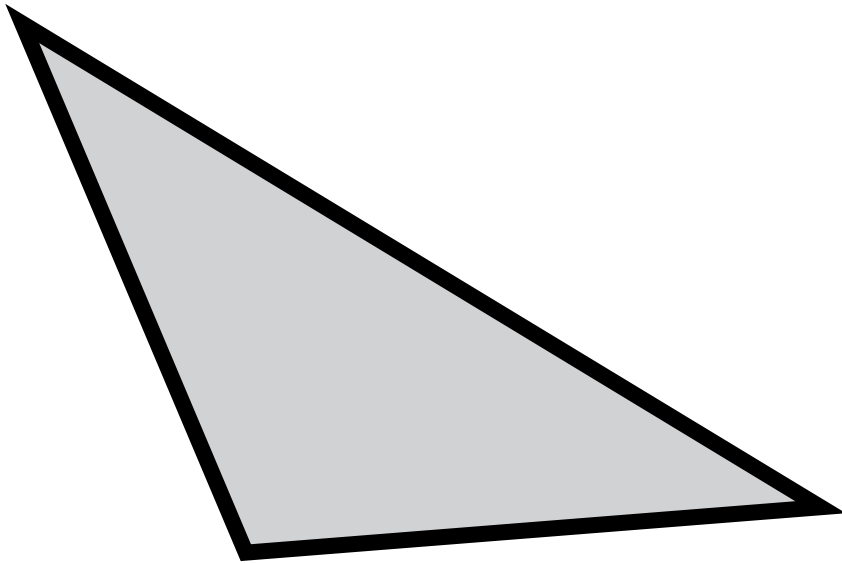

c)

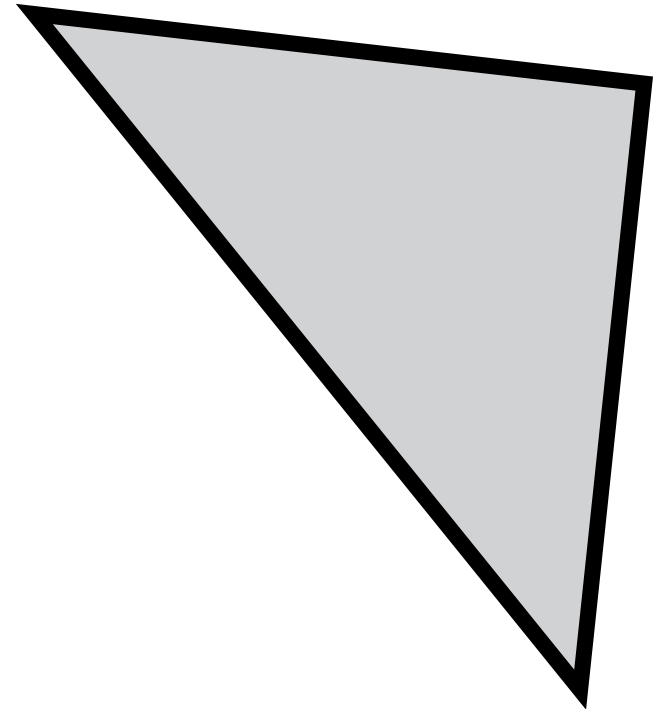

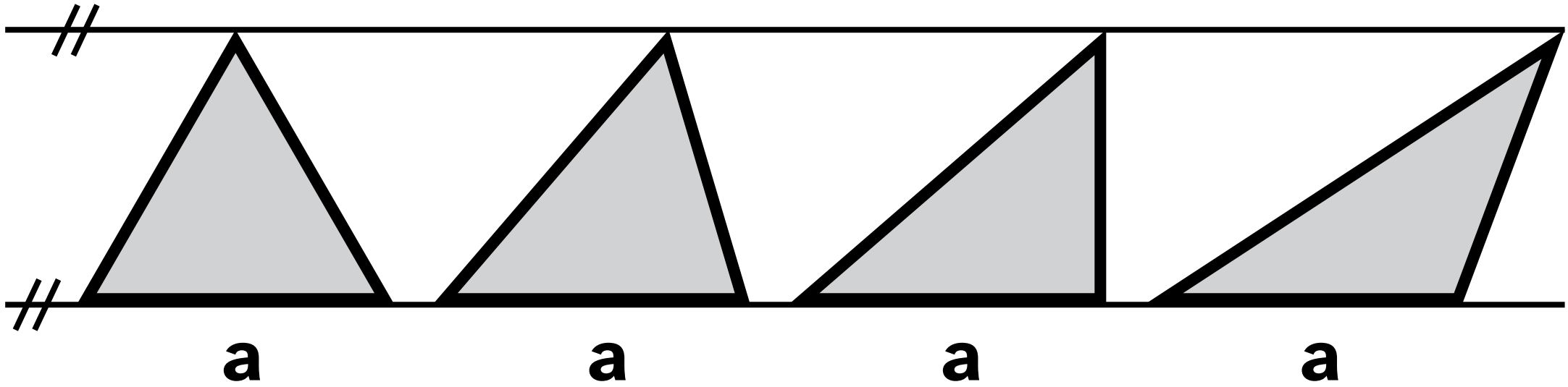
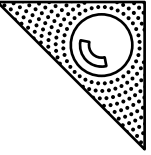

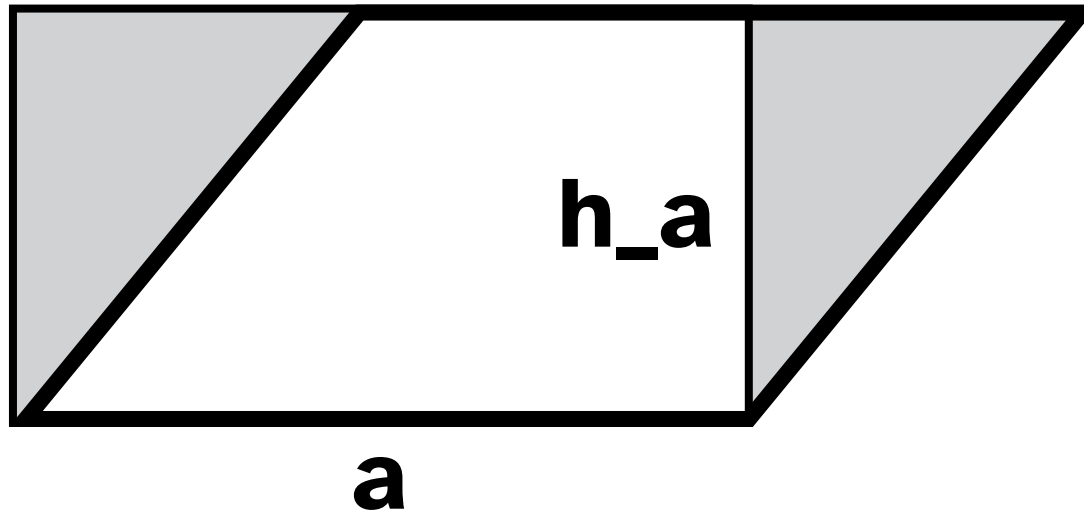
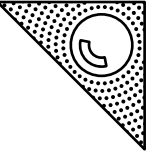

a)

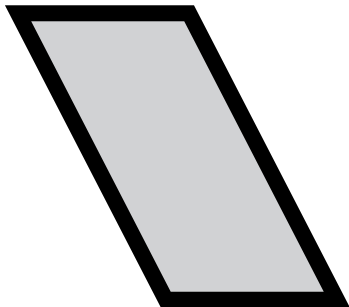

b)



c)

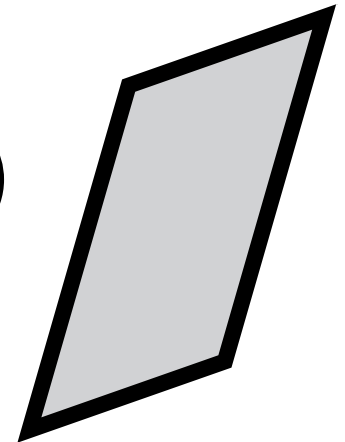

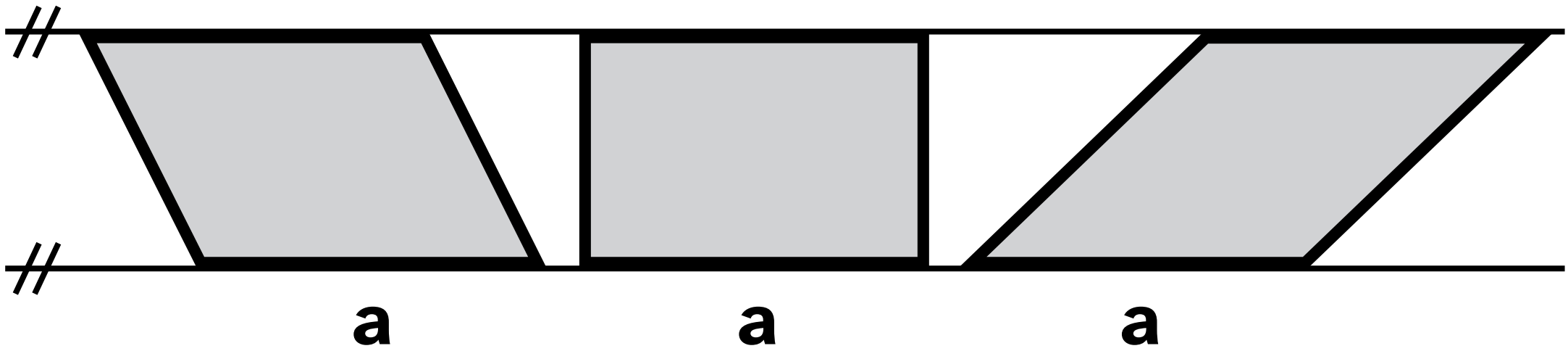
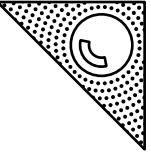

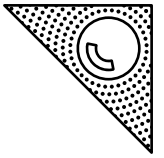

a)

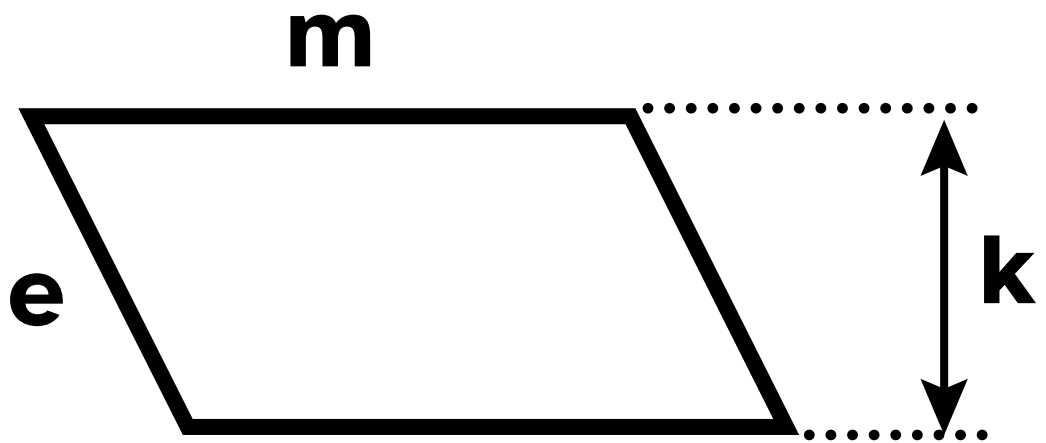

b)

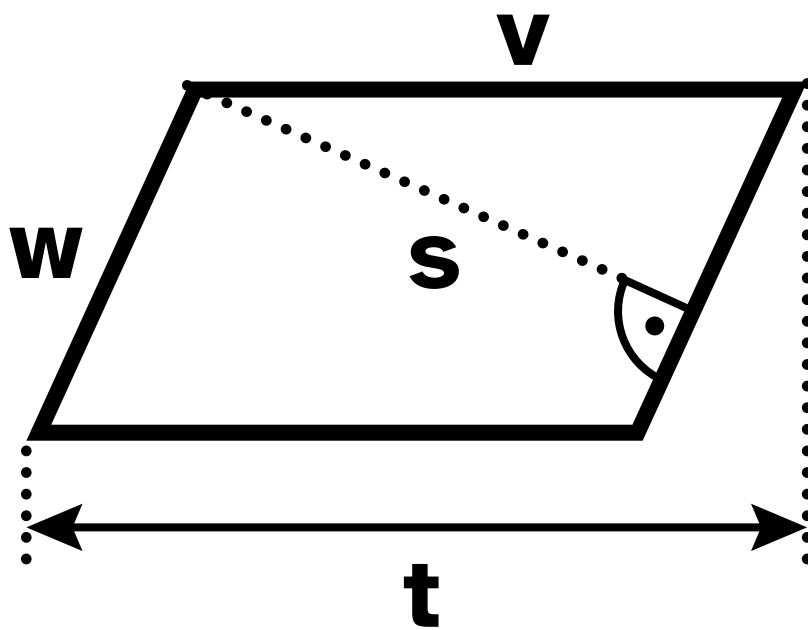

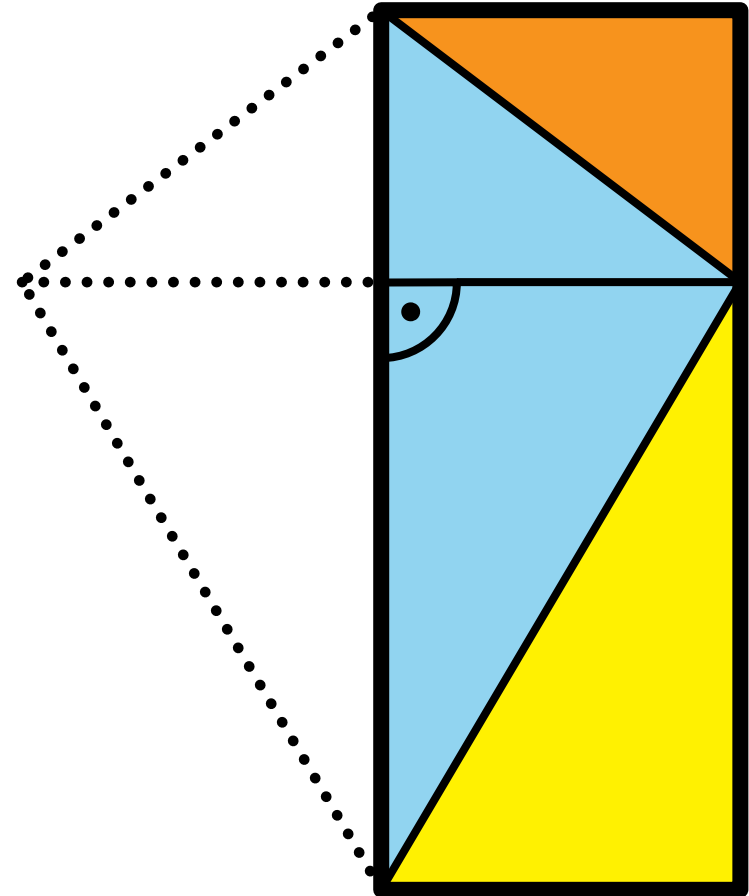
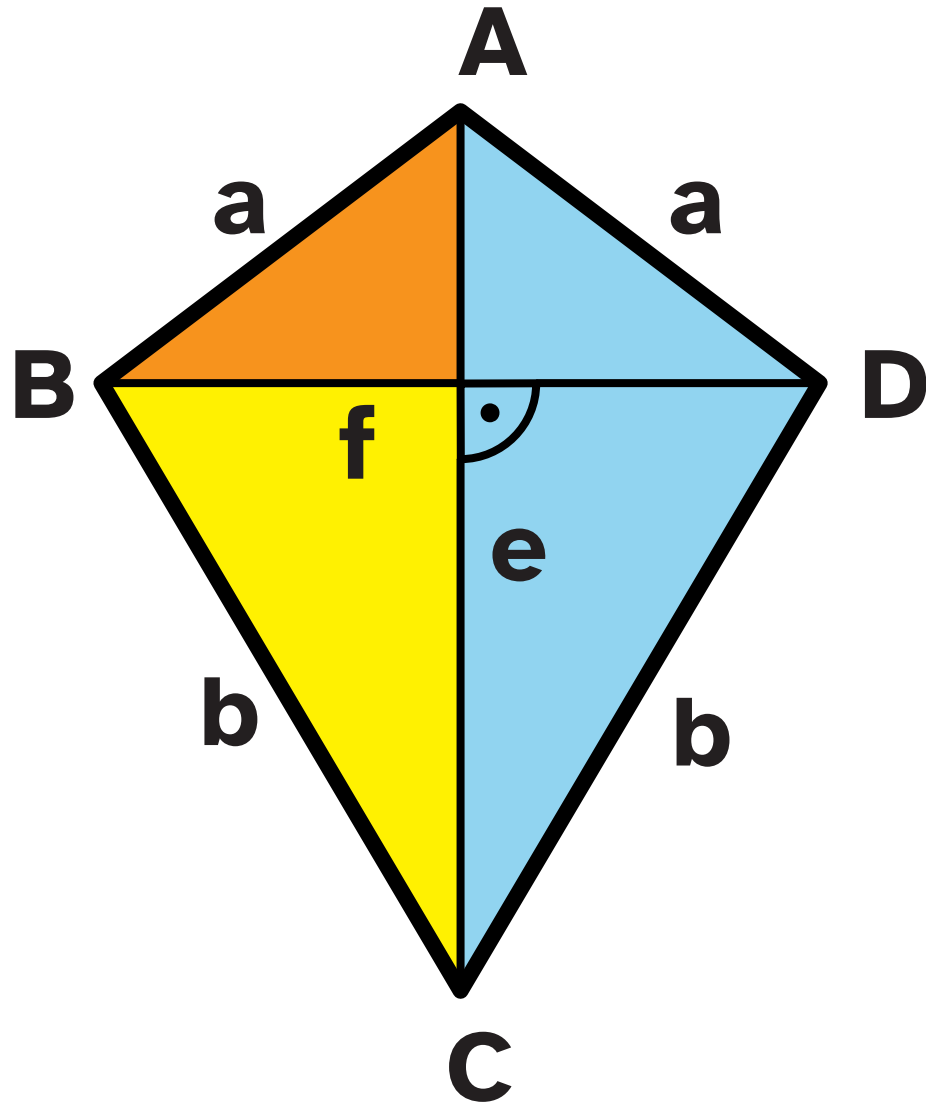
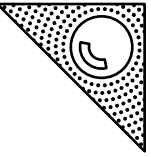

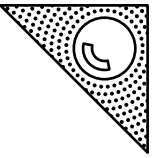

a)

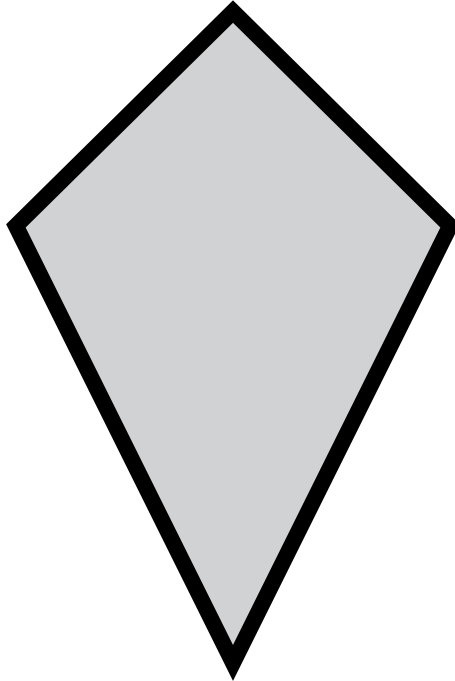

b)

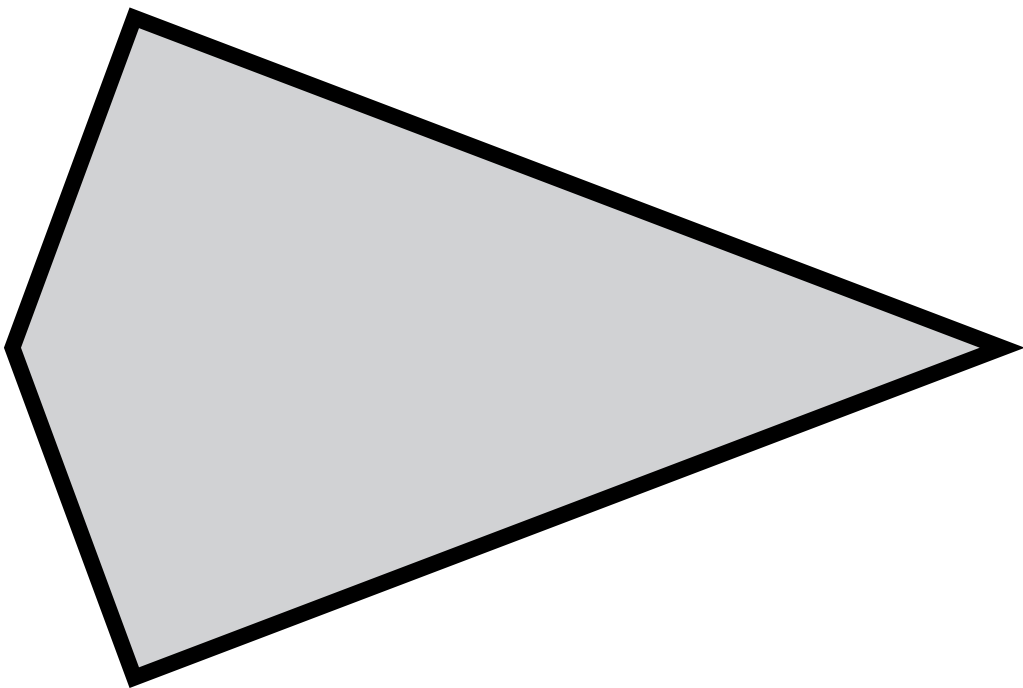

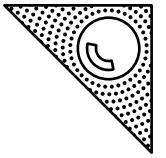

a)

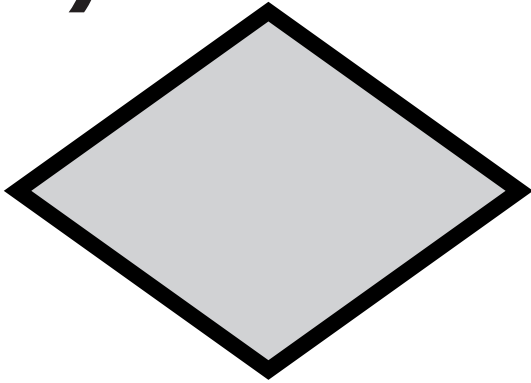

b)

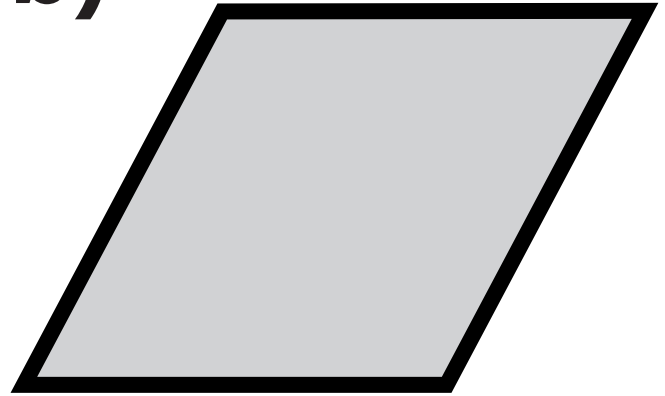

a)

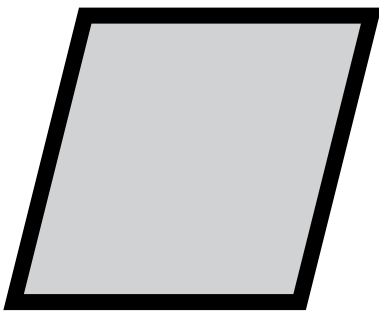

b)

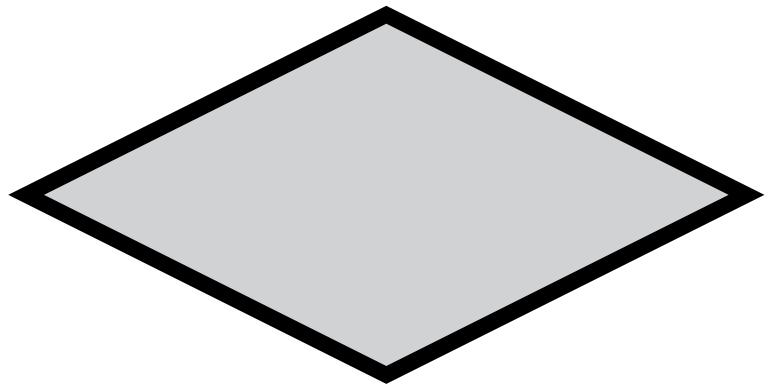

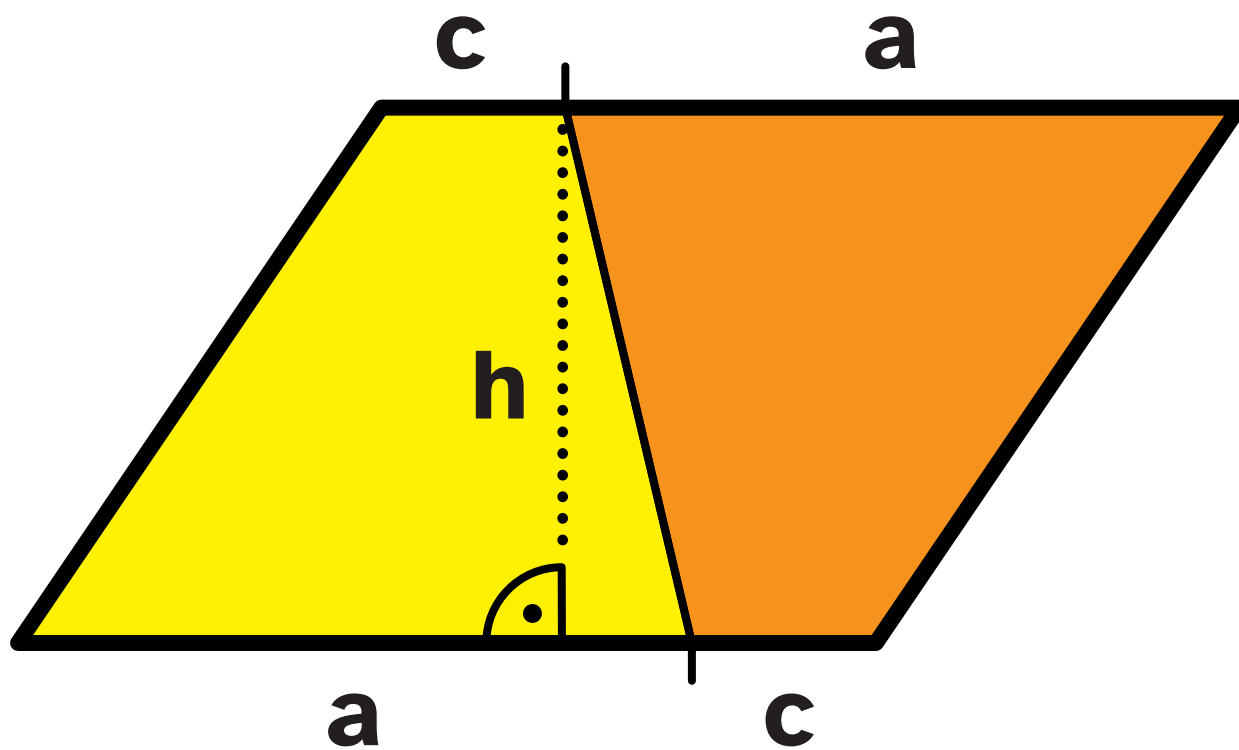
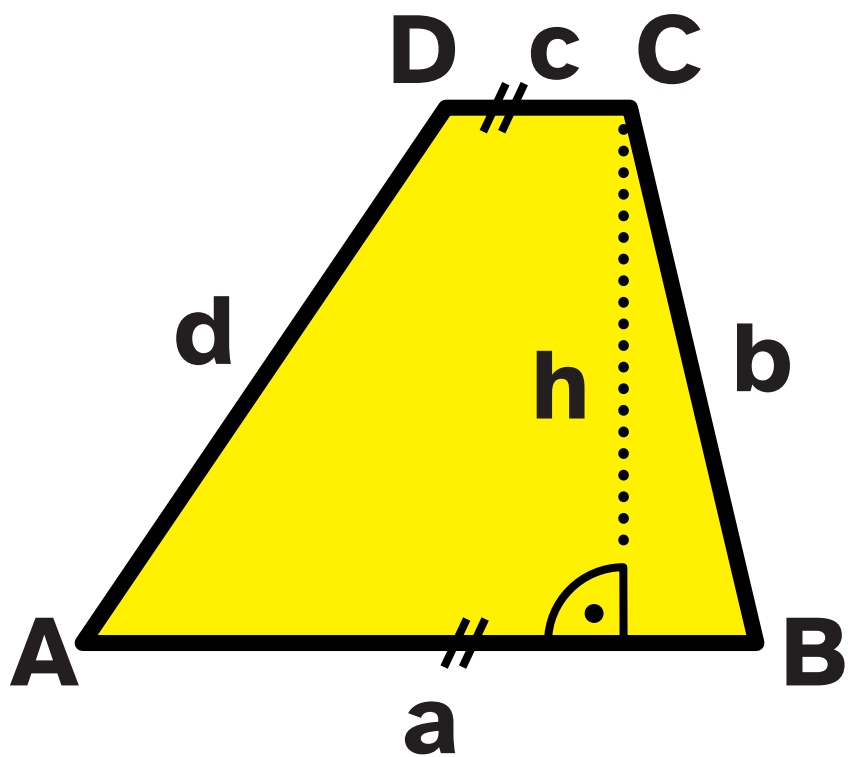
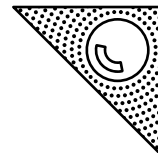

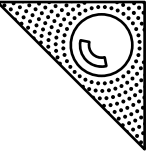

a)

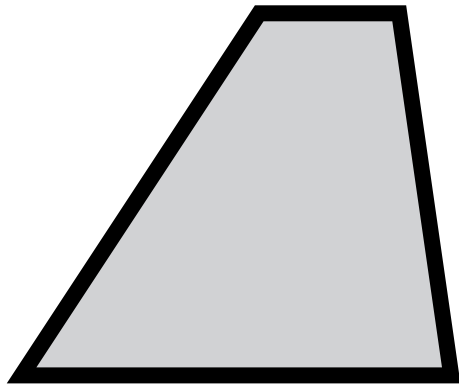

b)

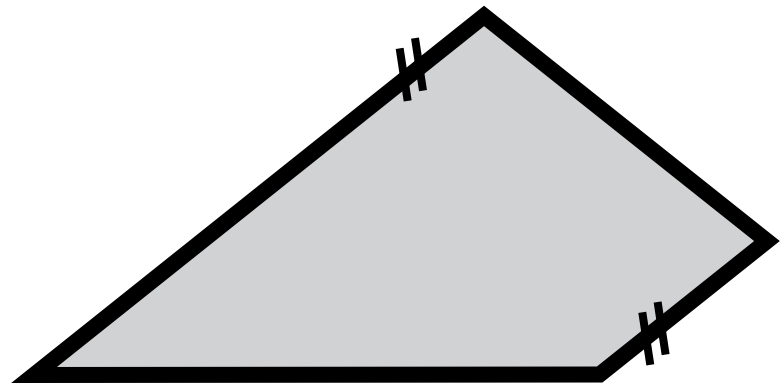

Plus3

//S.64 267

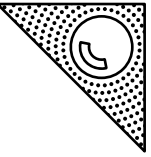

a)

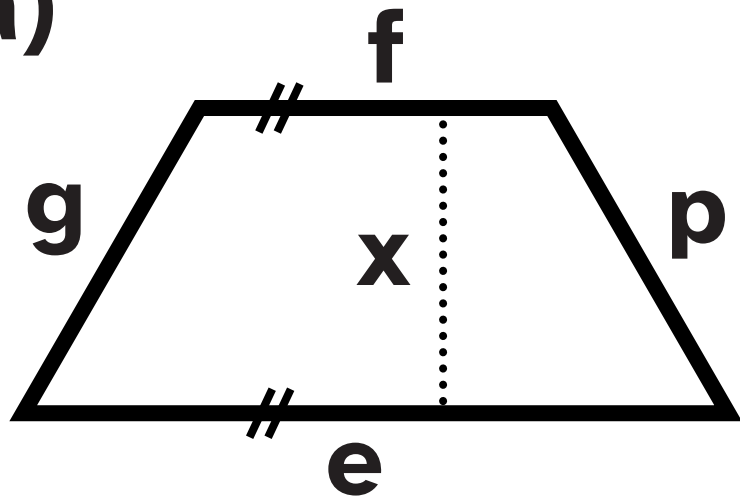

b)

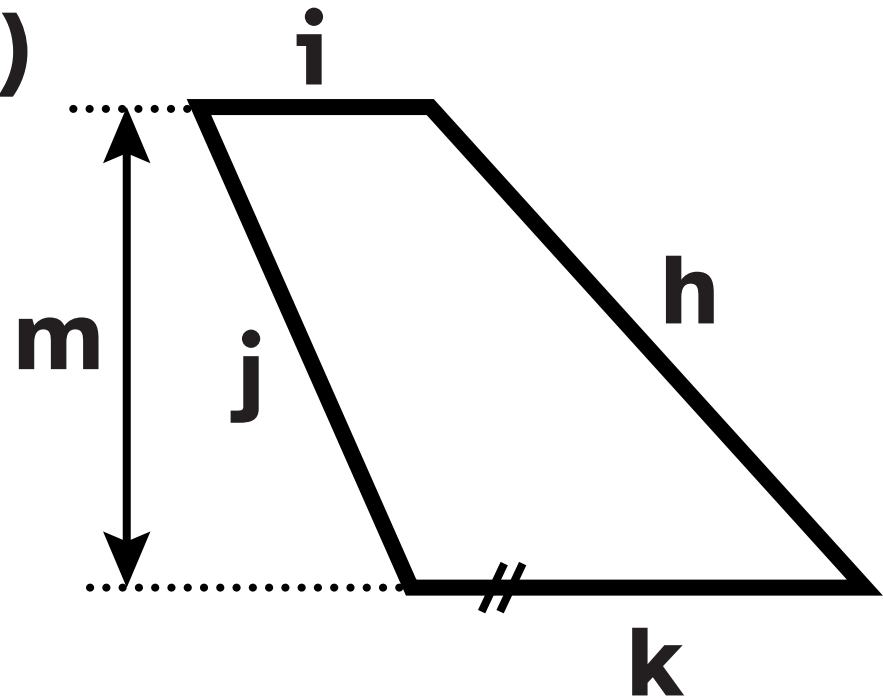

c)

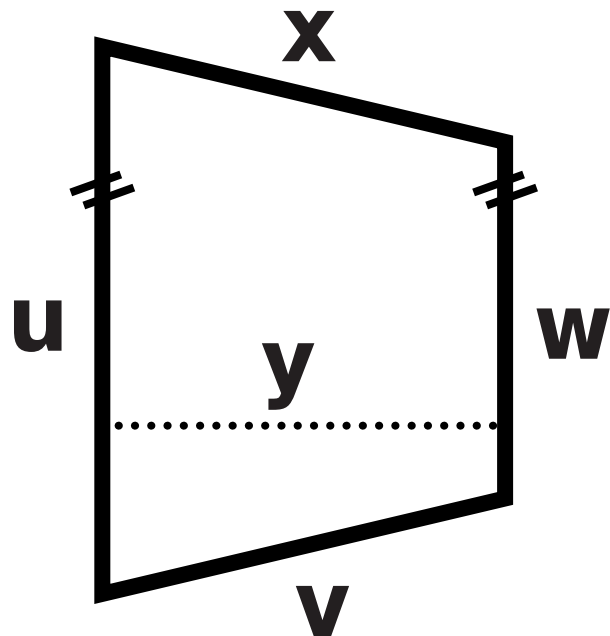

d)

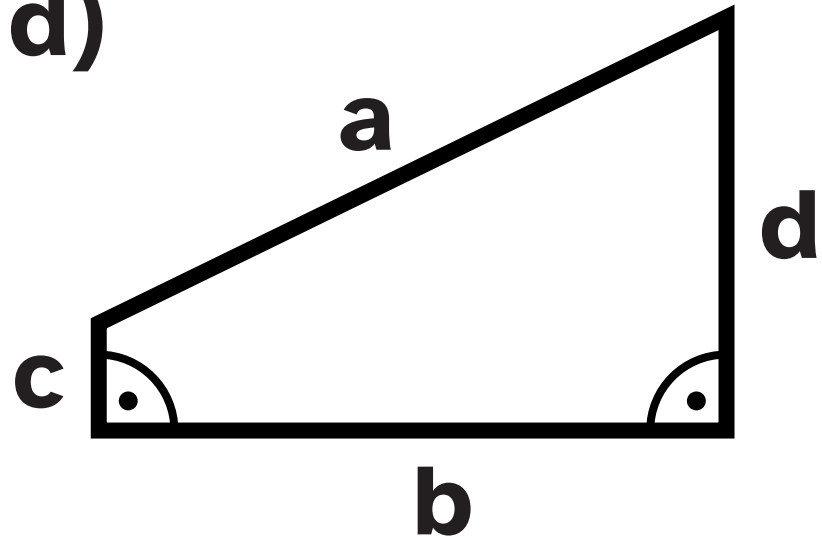

Plus3

a)

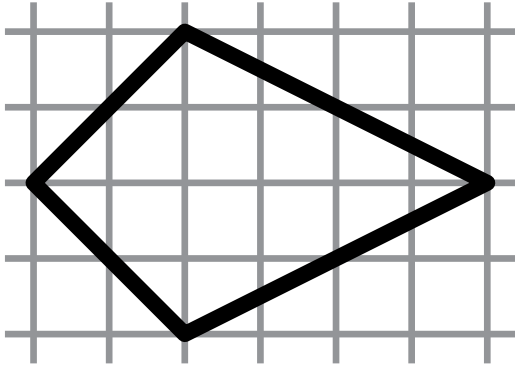

b)

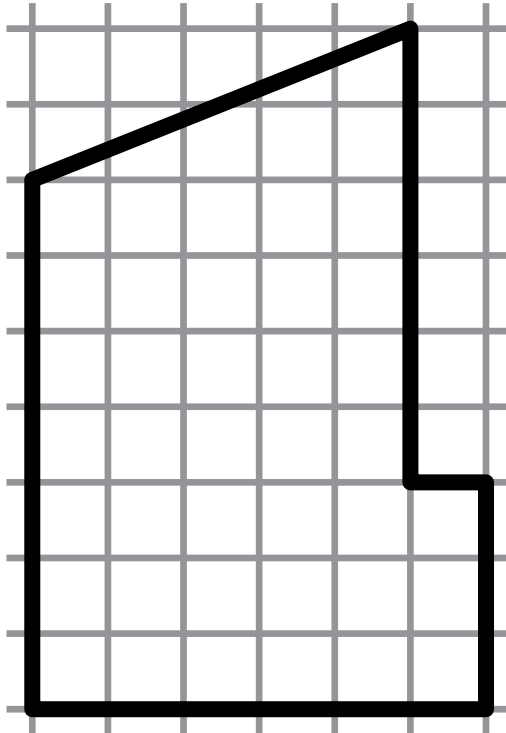

S.65 268

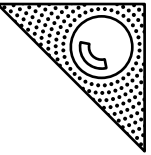

c)

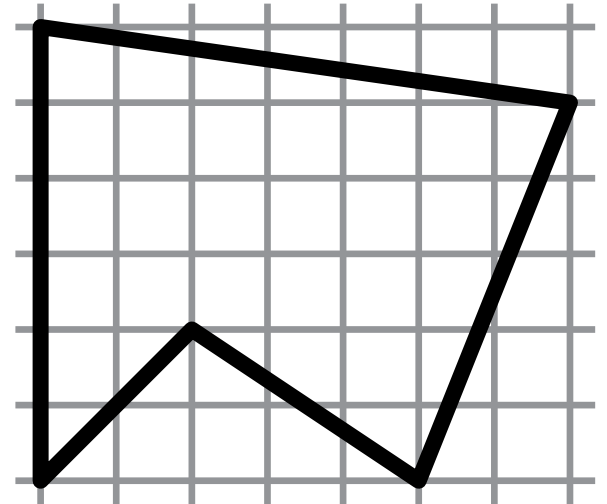

d)

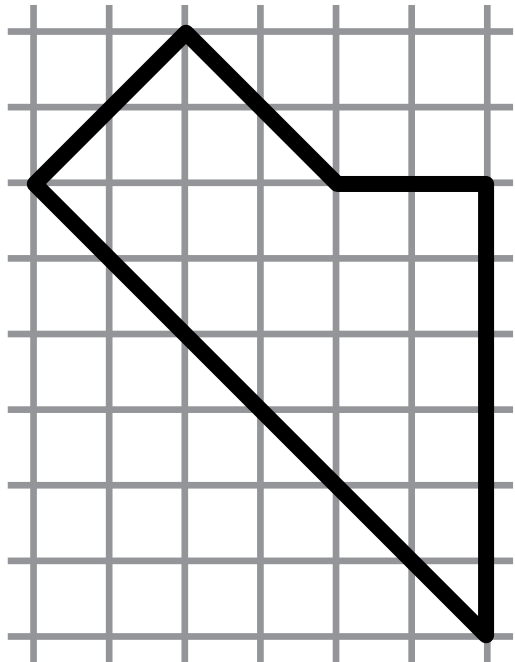

e)

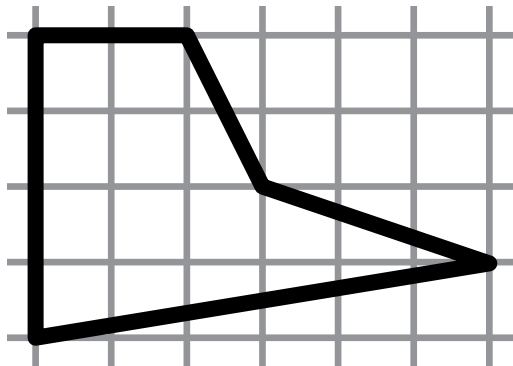

f)

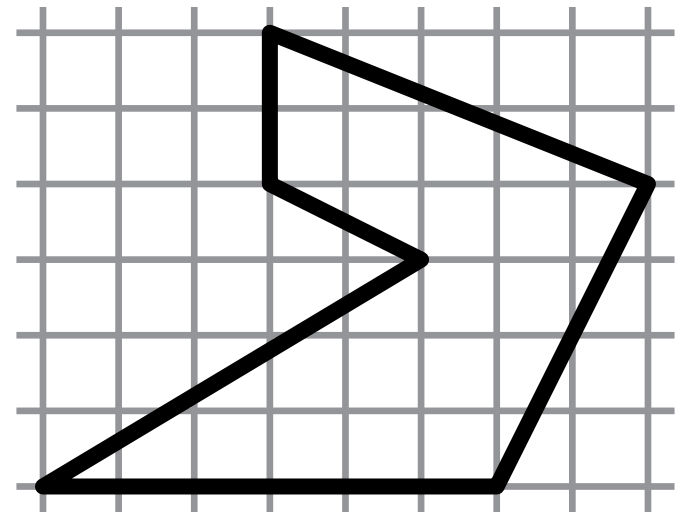

Plus3

S.65 269

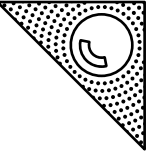

a)

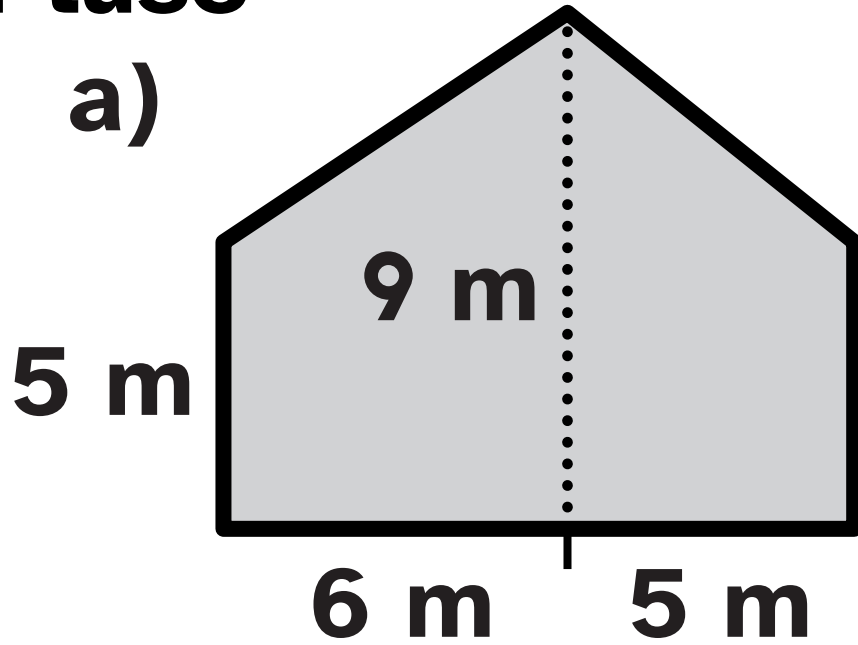

b)

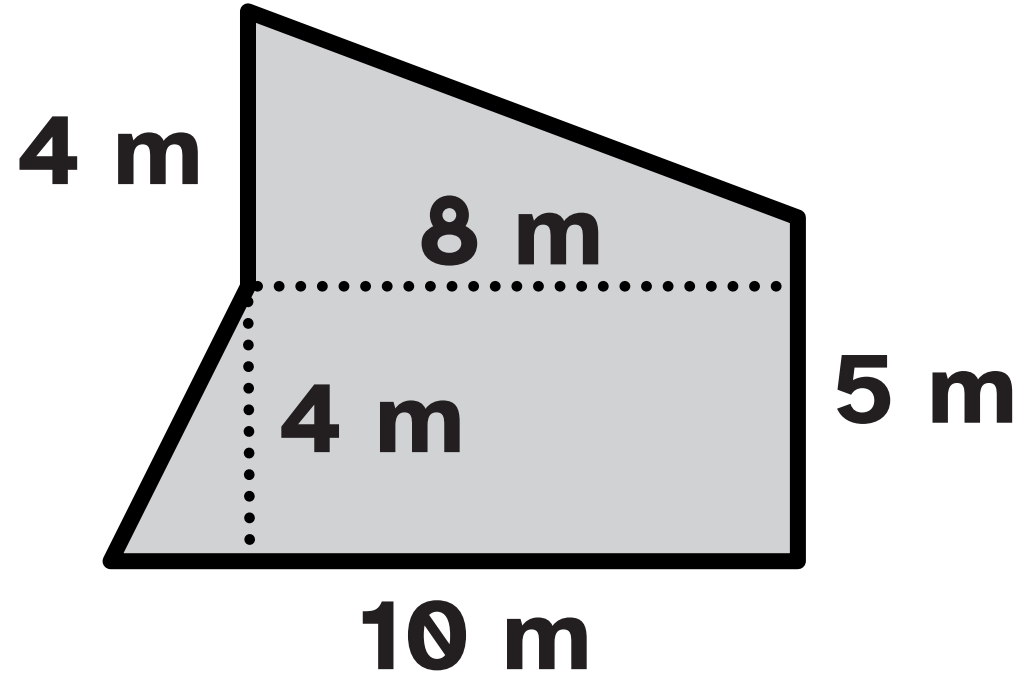

c)

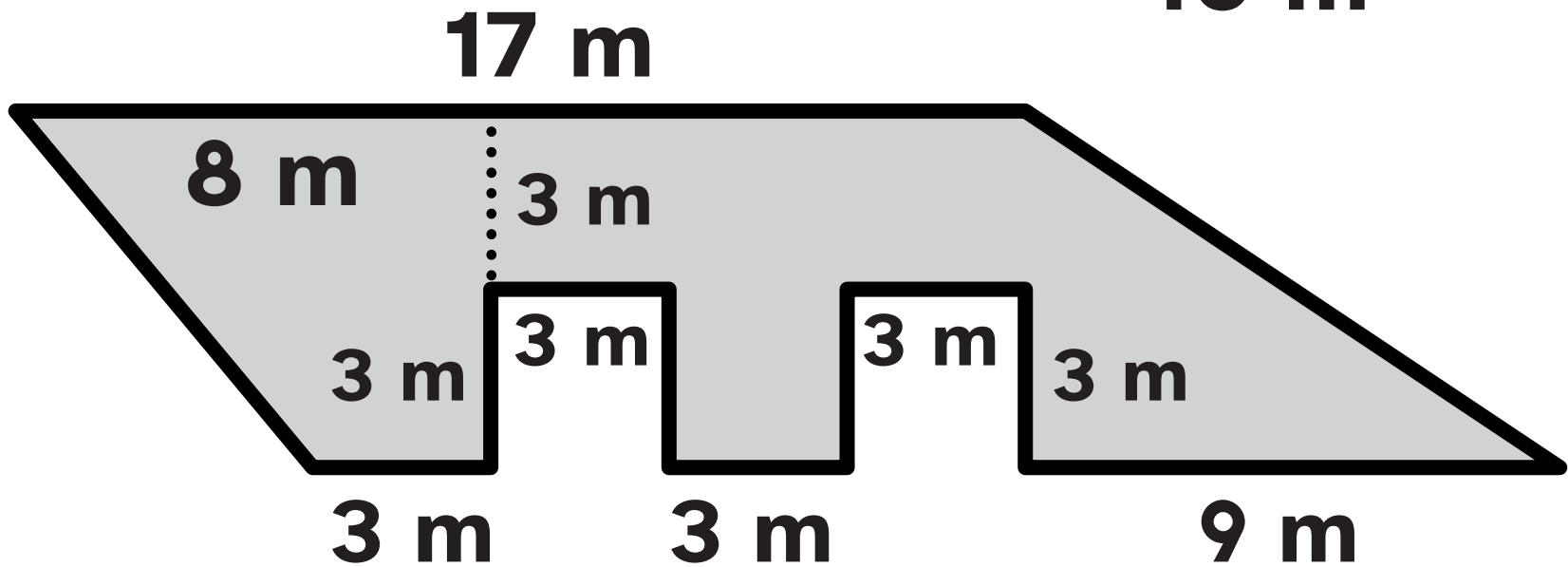

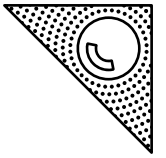

a)

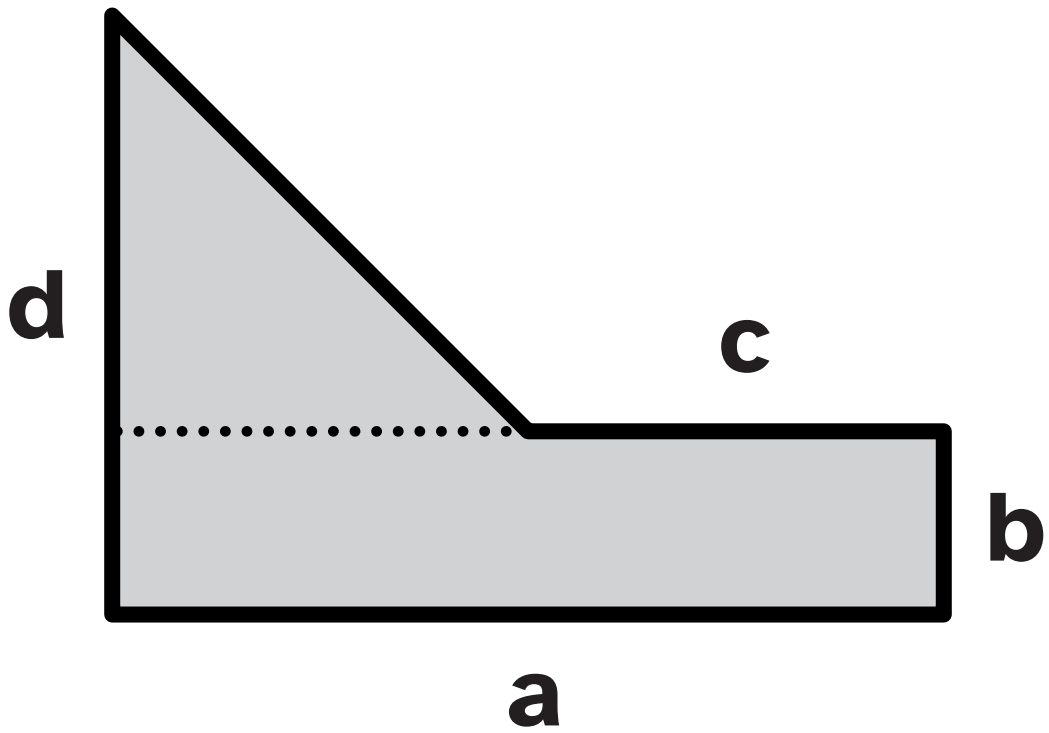

b)

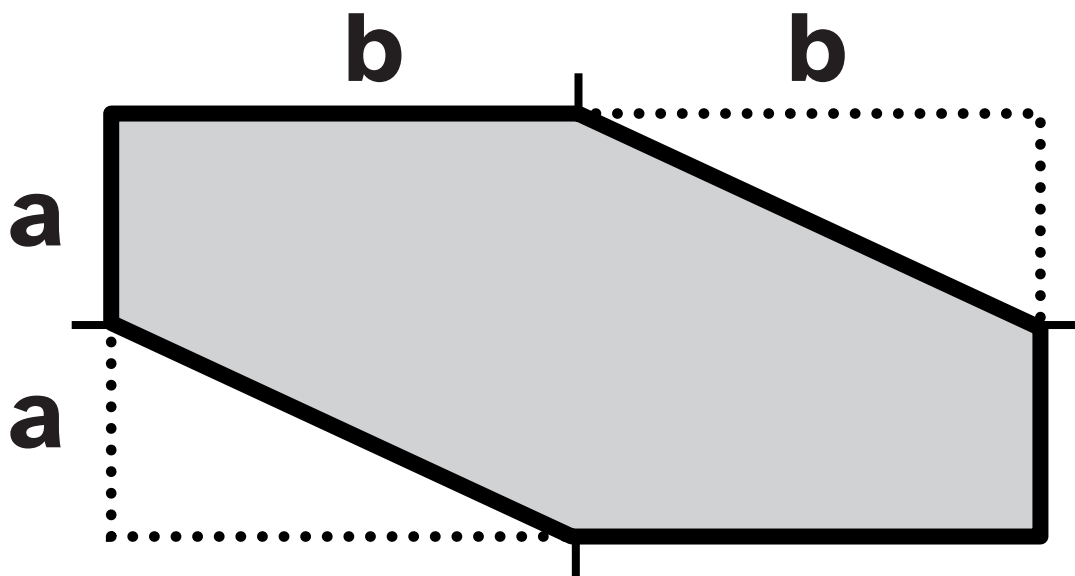

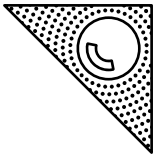

a)

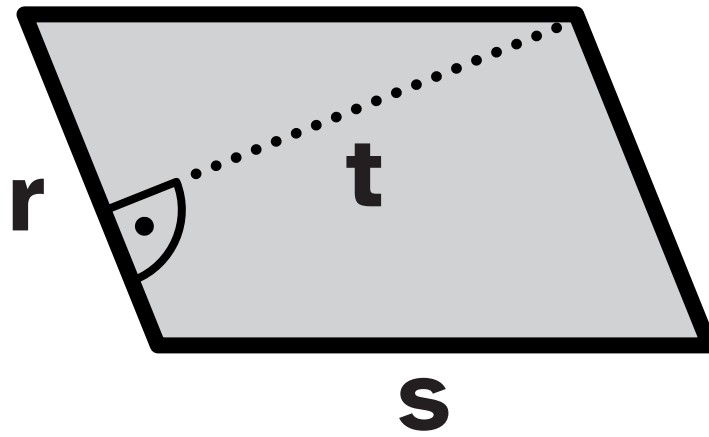

b)

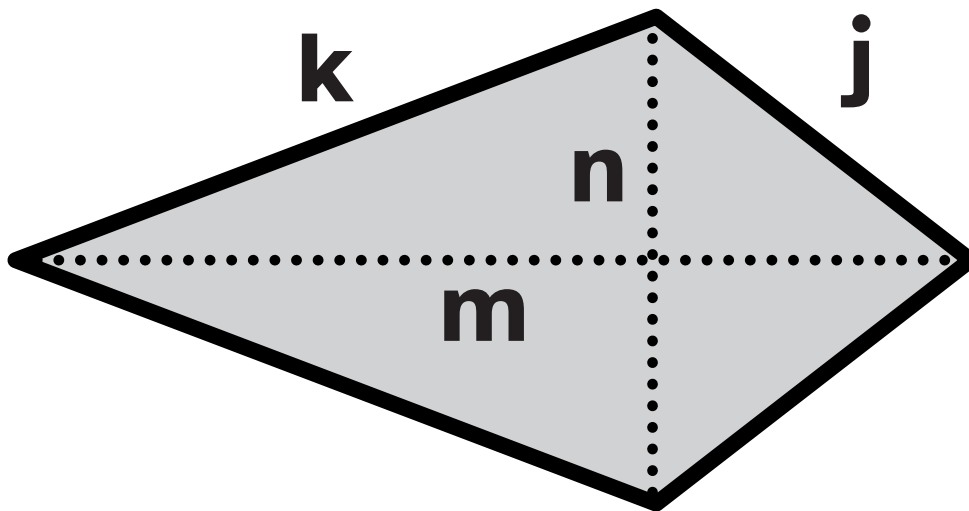

c)

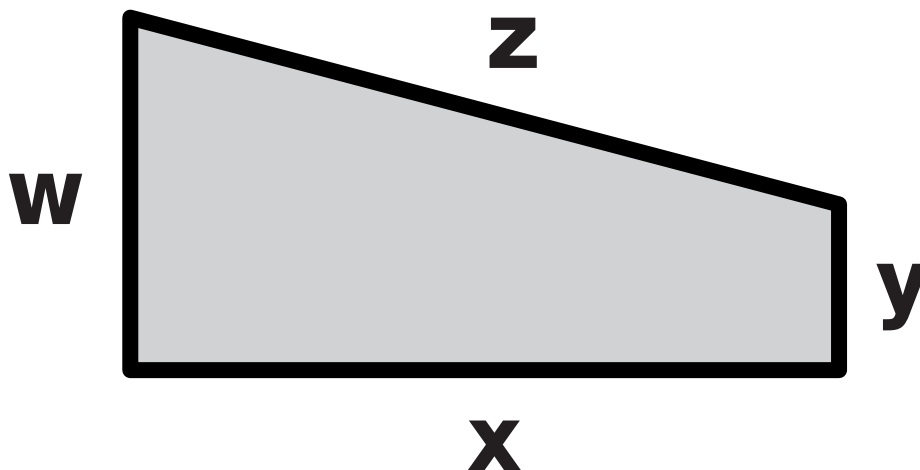

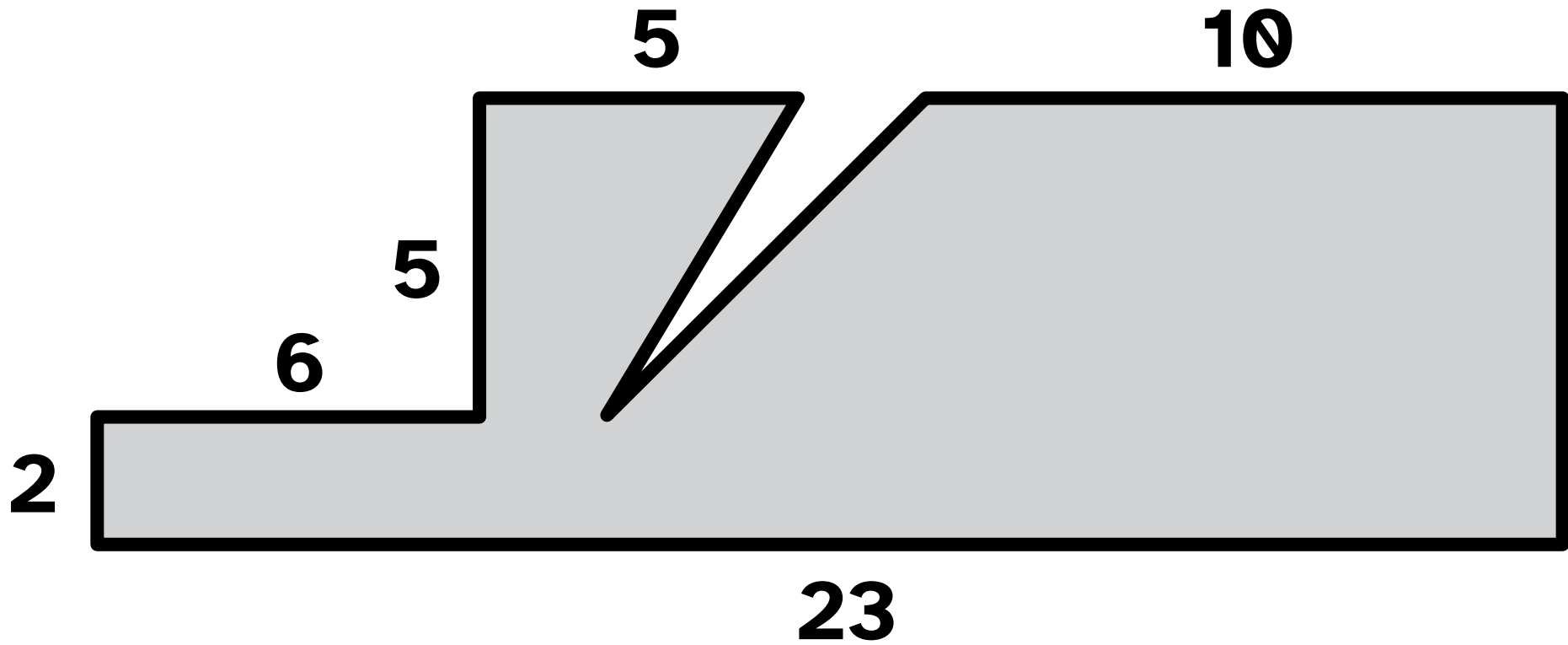
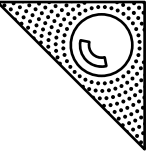

Plus3

S.89 389, 390

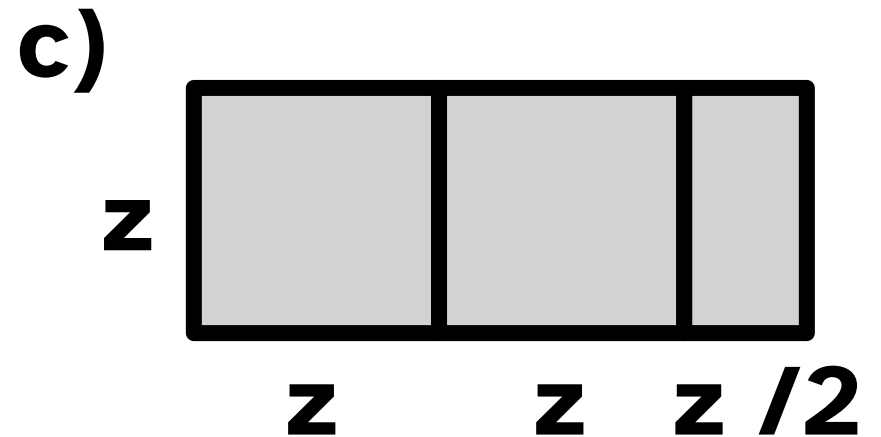
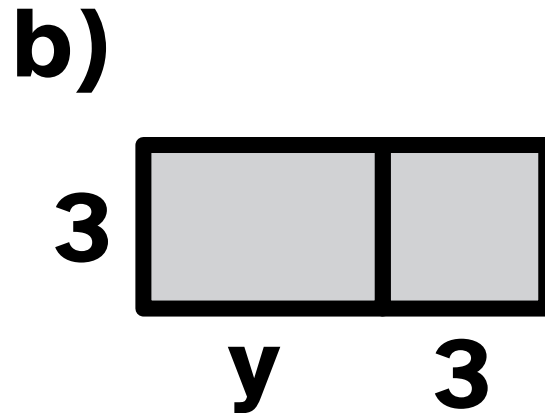
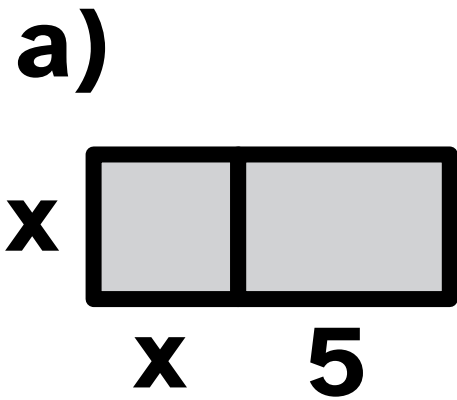
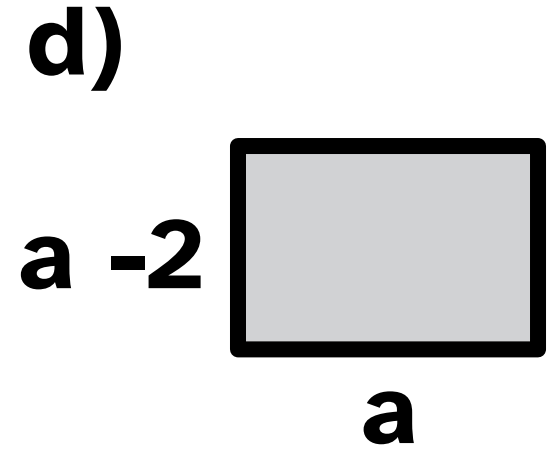
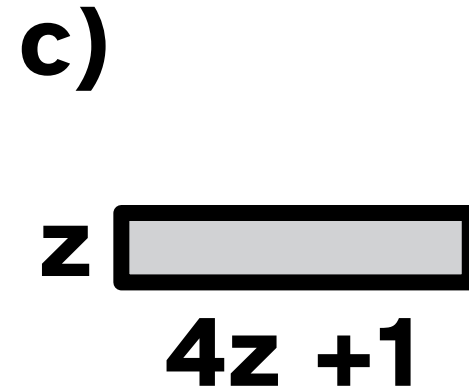
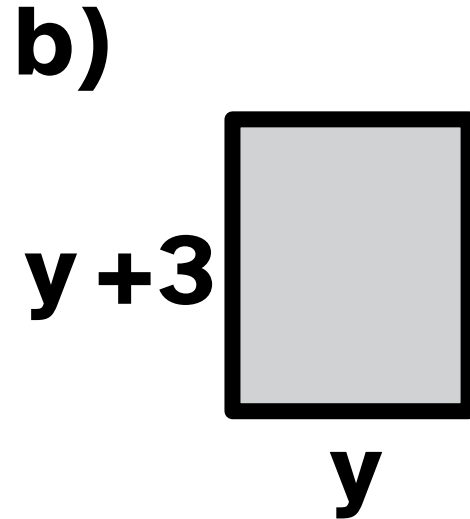
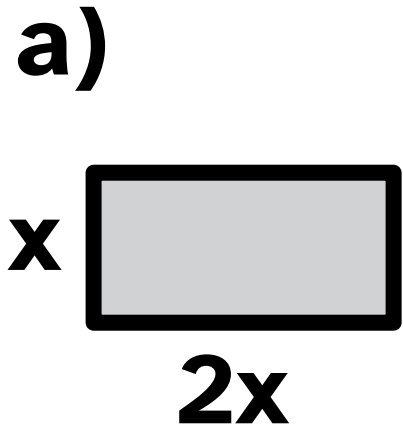
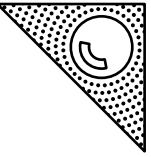

Plus3

S.89 391, 392

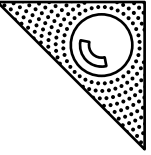

a)

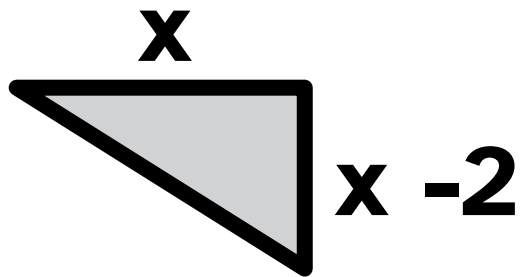

b)

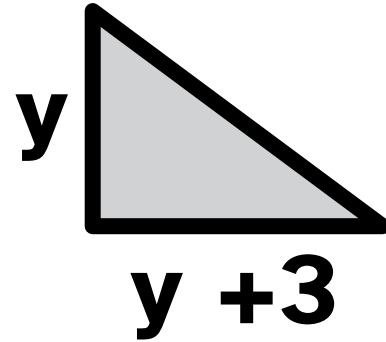

c)

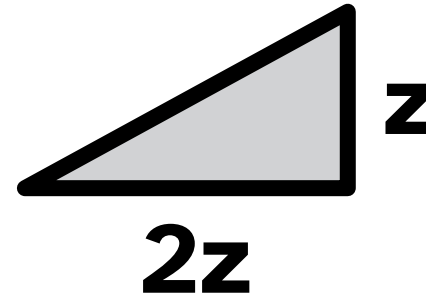

d)

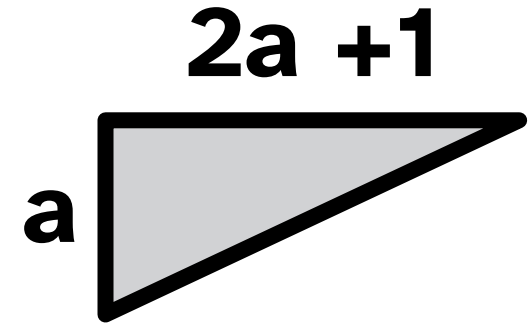

a)

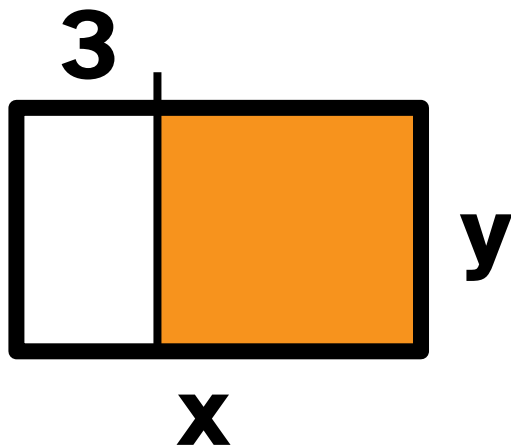

b)

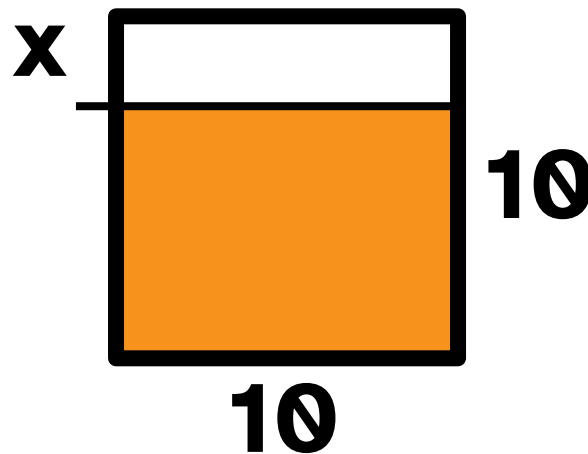

c)

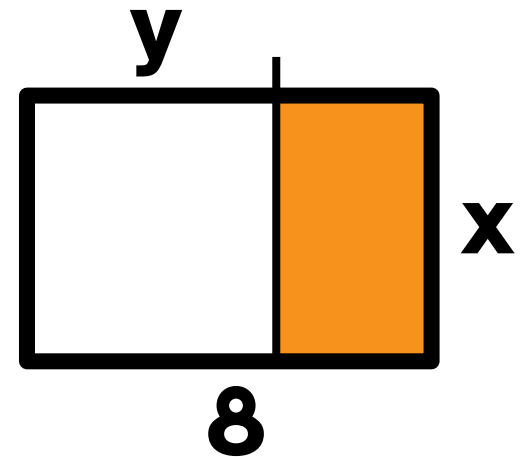

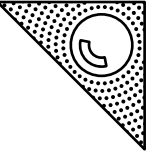

a)

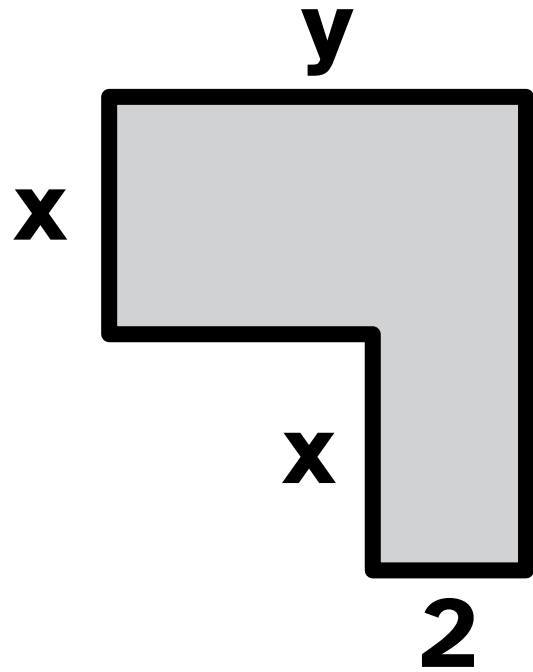

b)

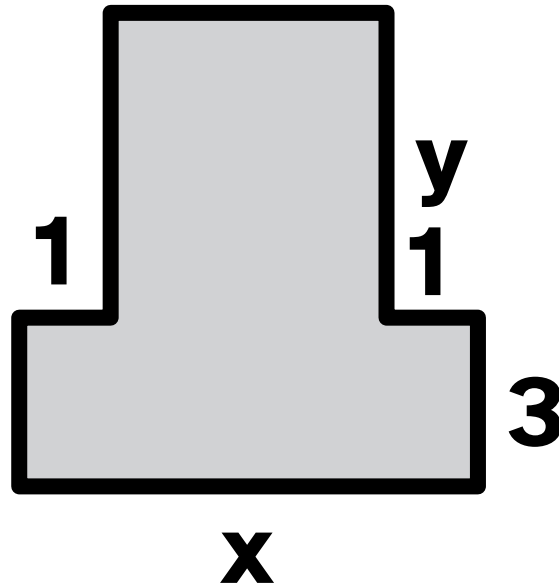

c)

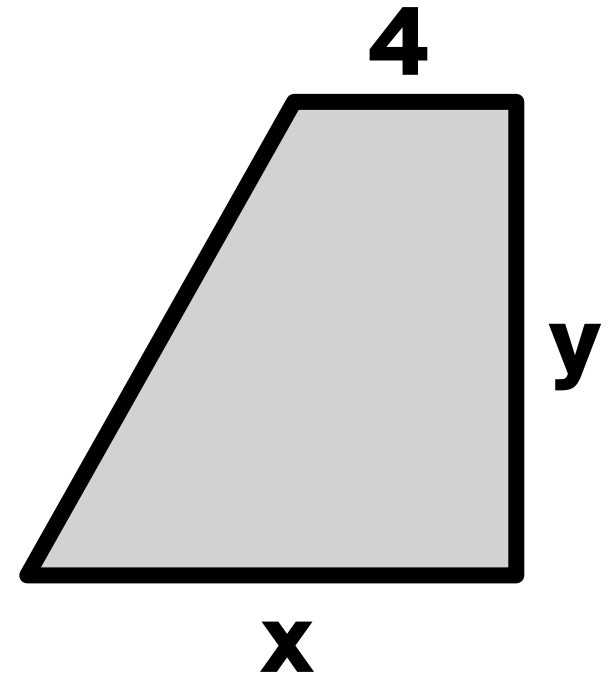

Plus3

S.118 522

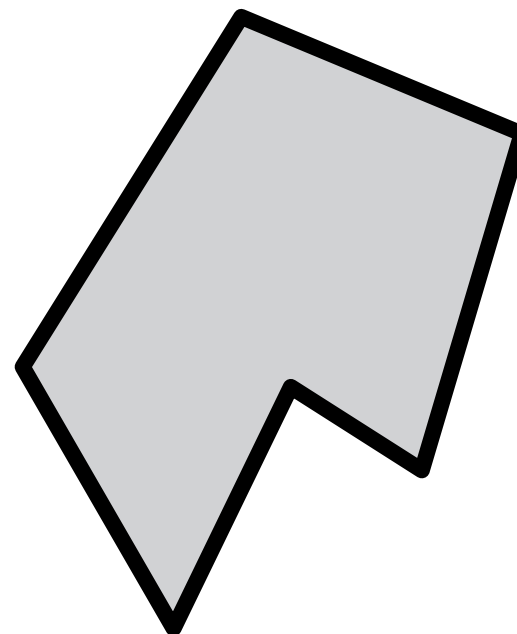
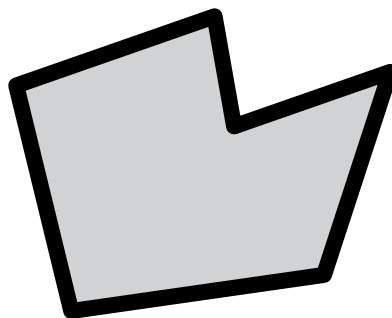
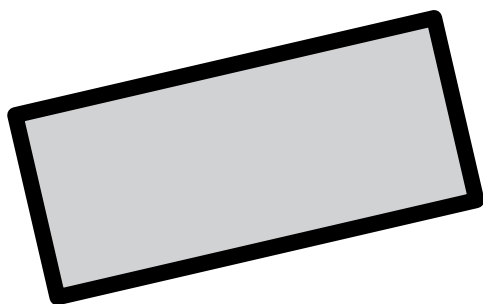
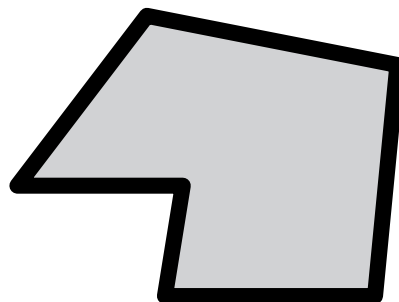
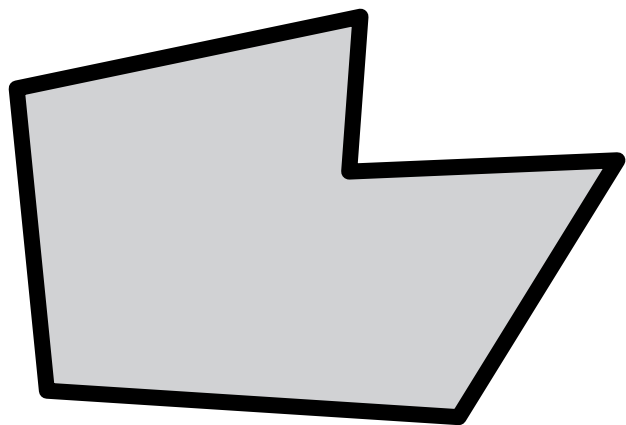
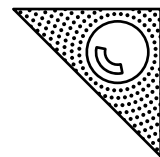

Plus3

S.125 553

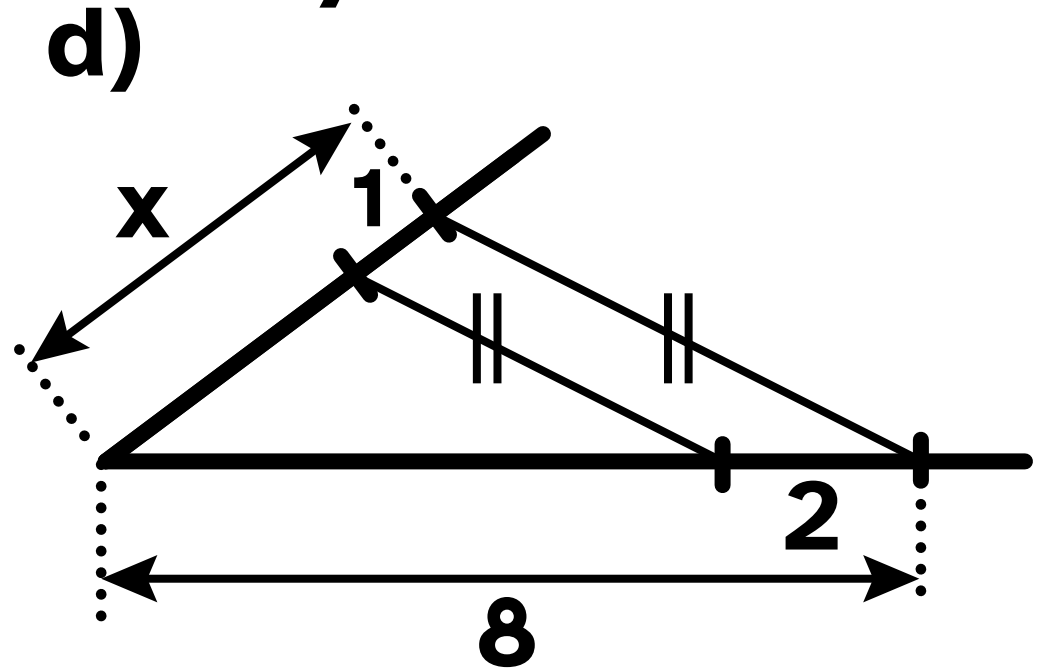
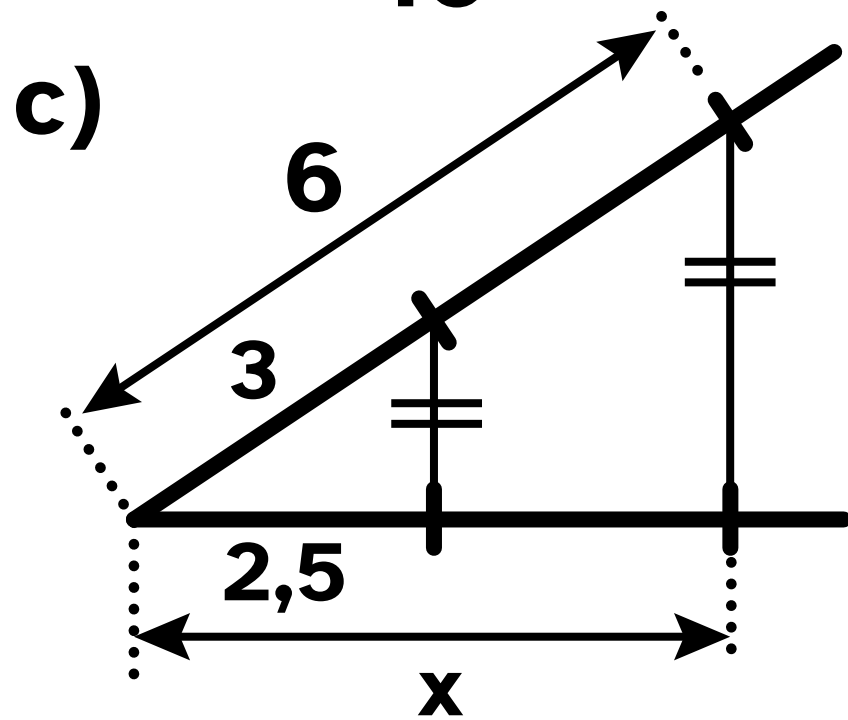
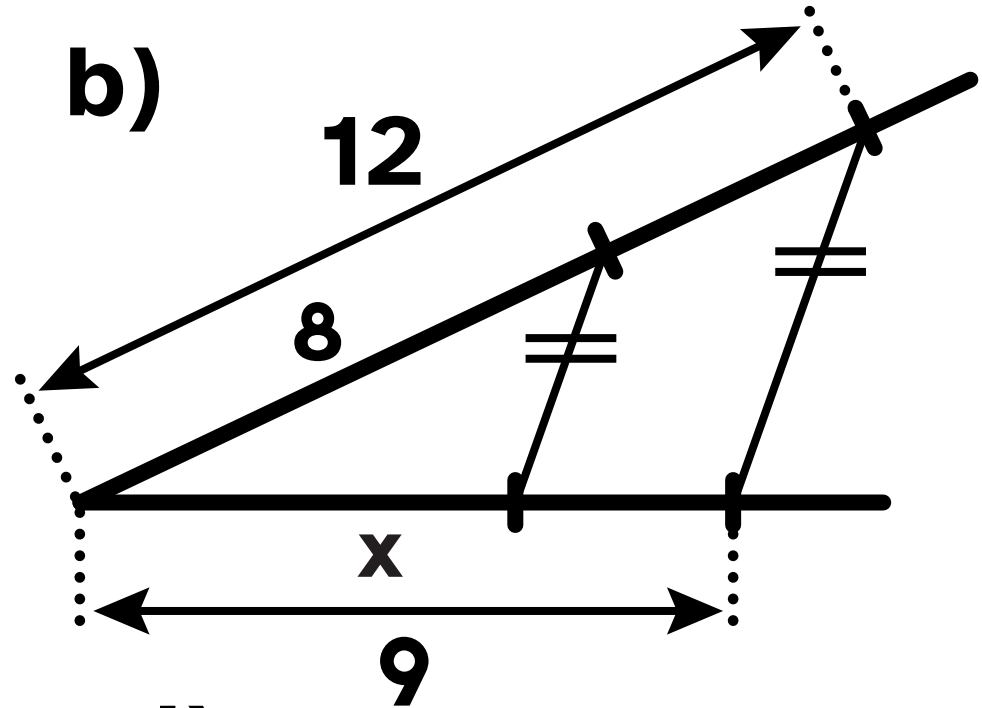
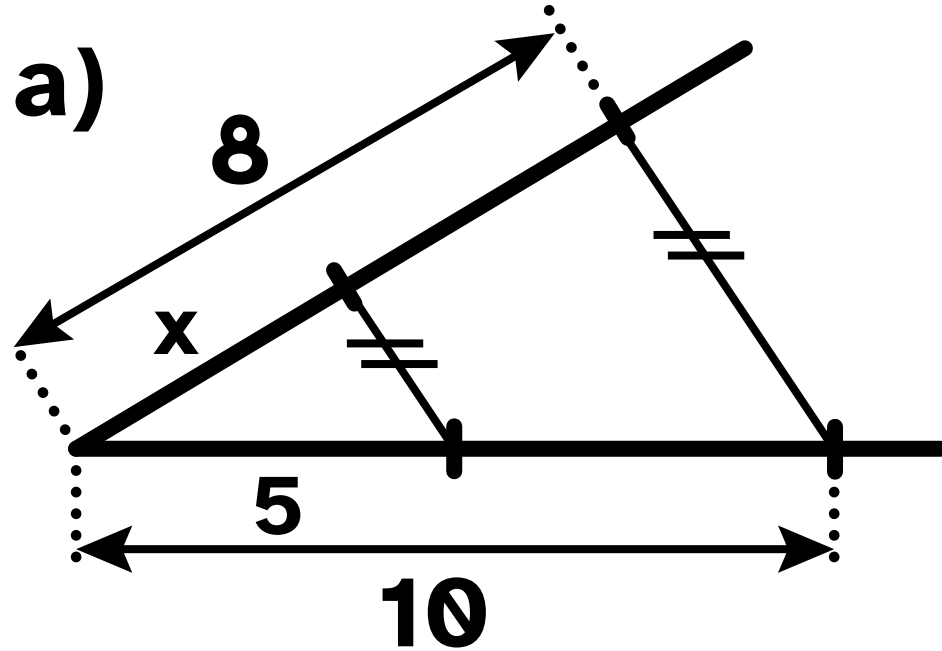
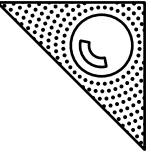

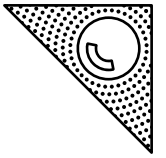

a)

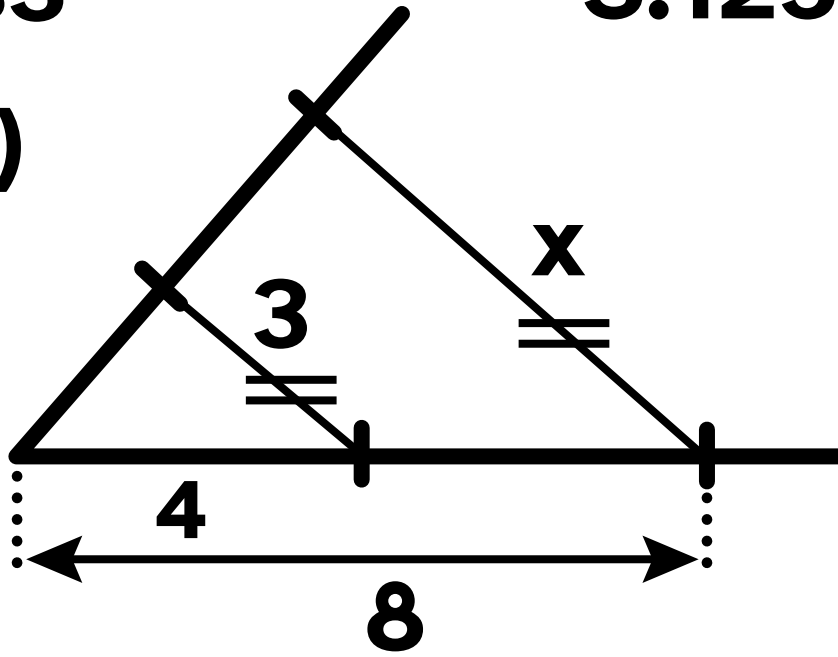

b)

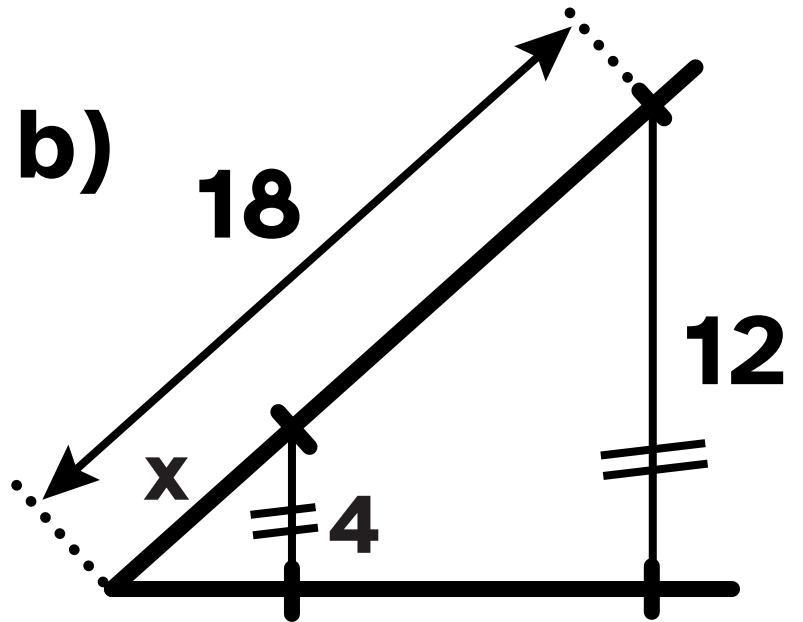

c)

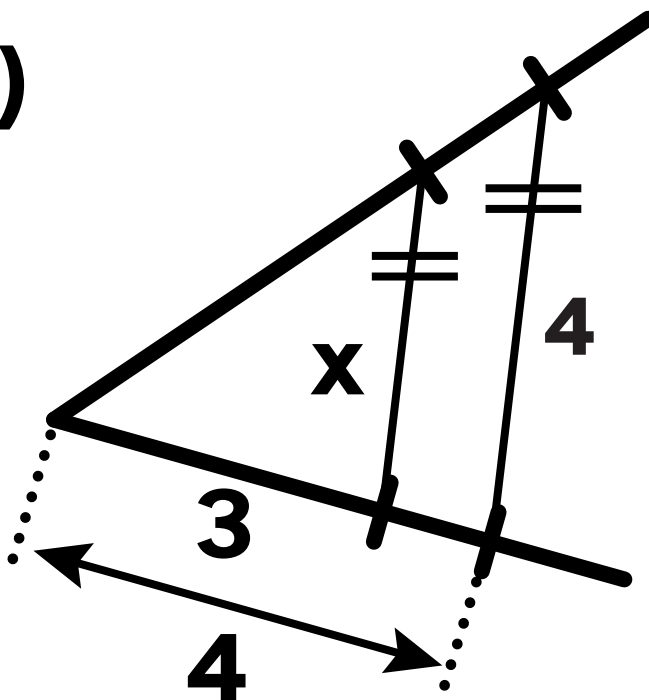

Plus3

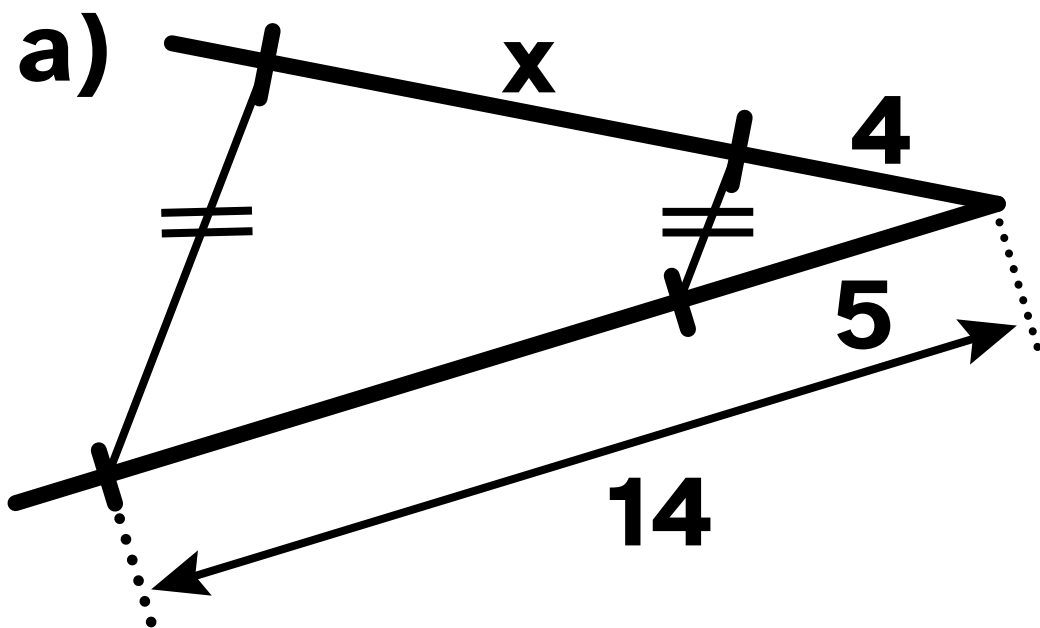

S.125 555

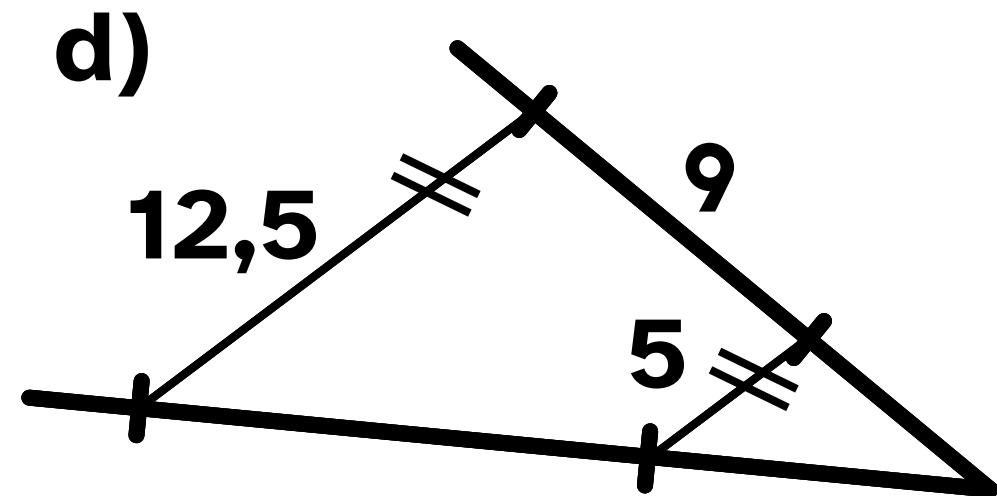
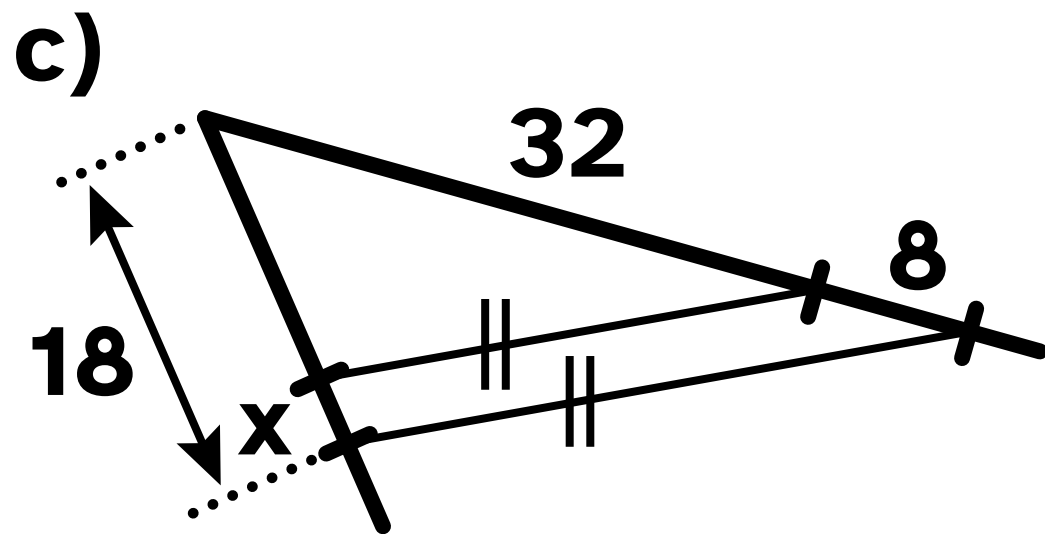
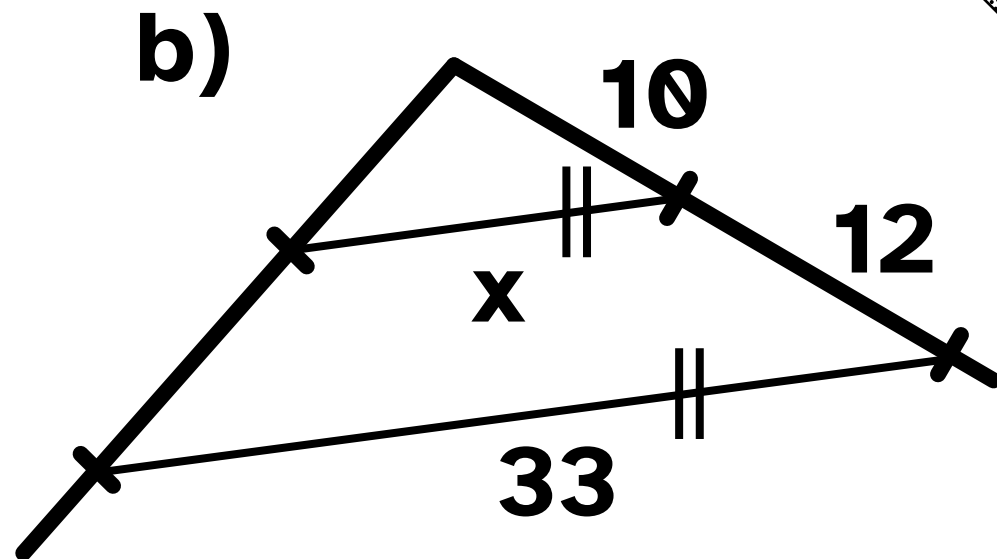
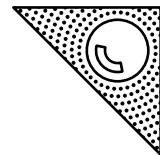

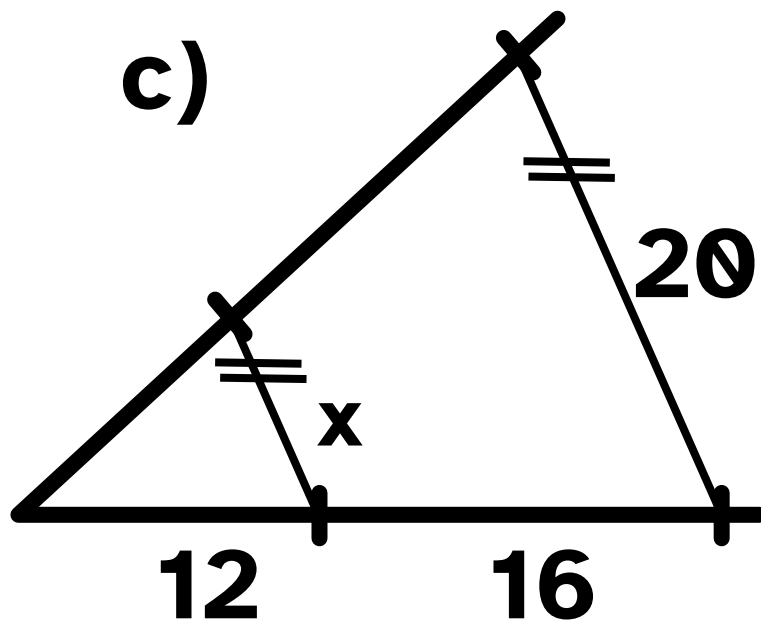
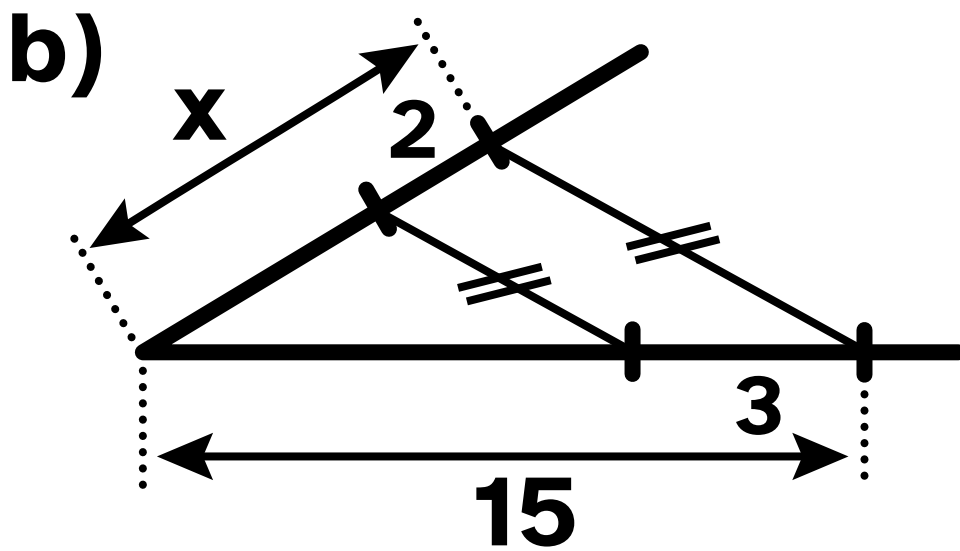
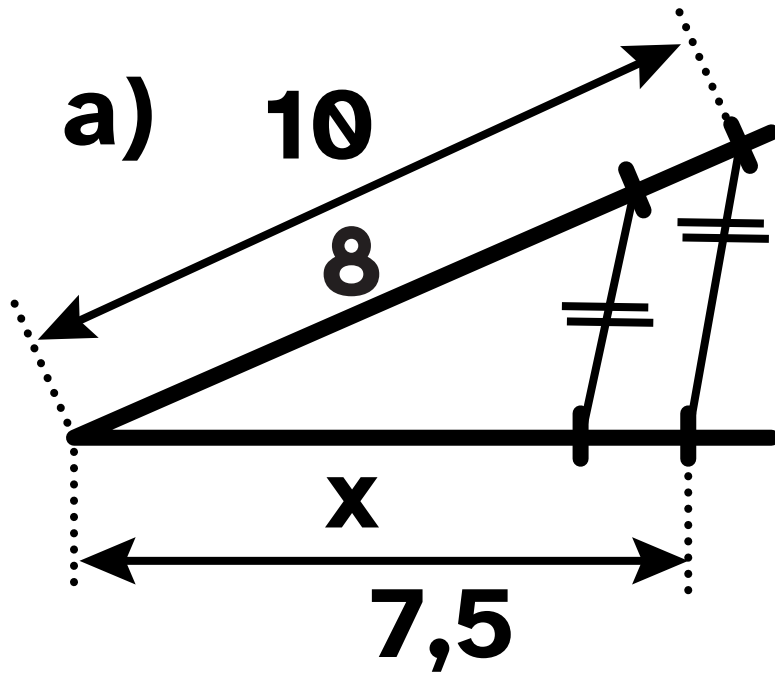
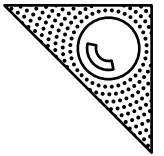

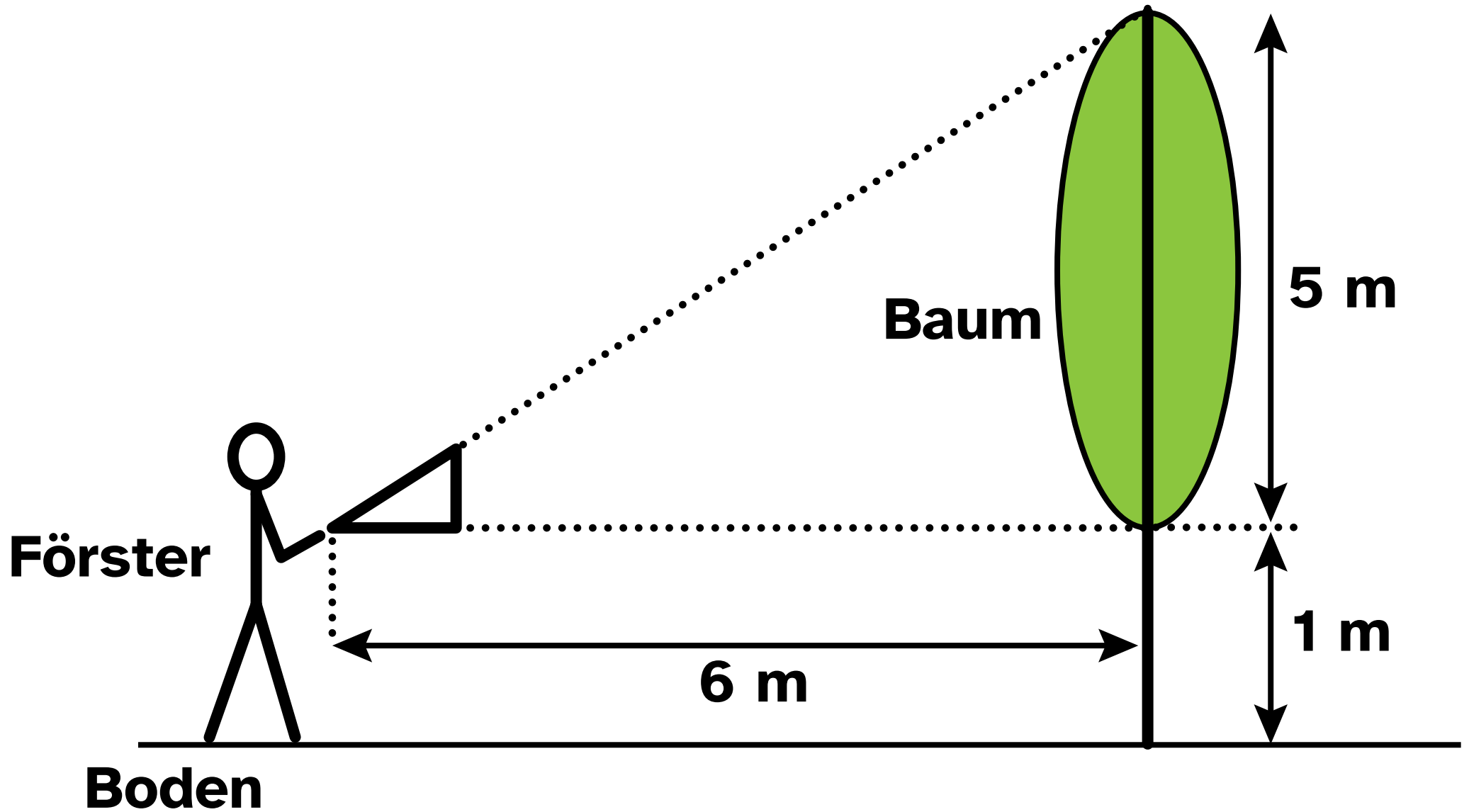
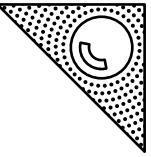

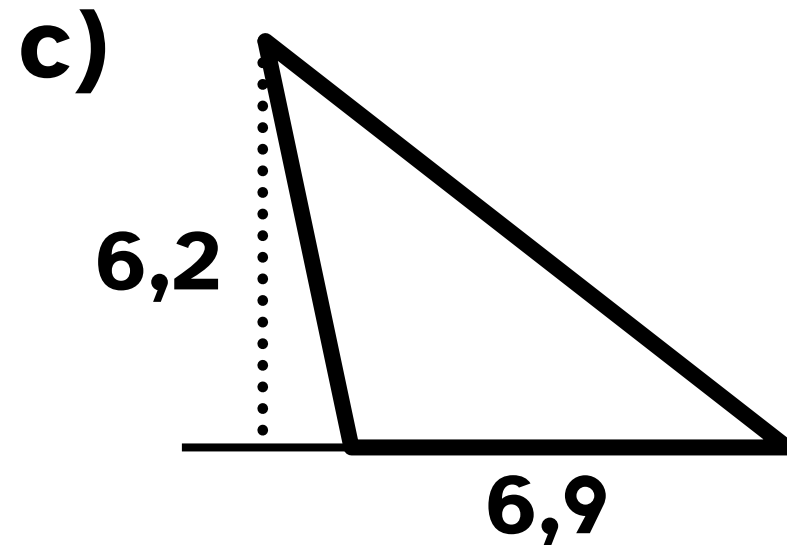
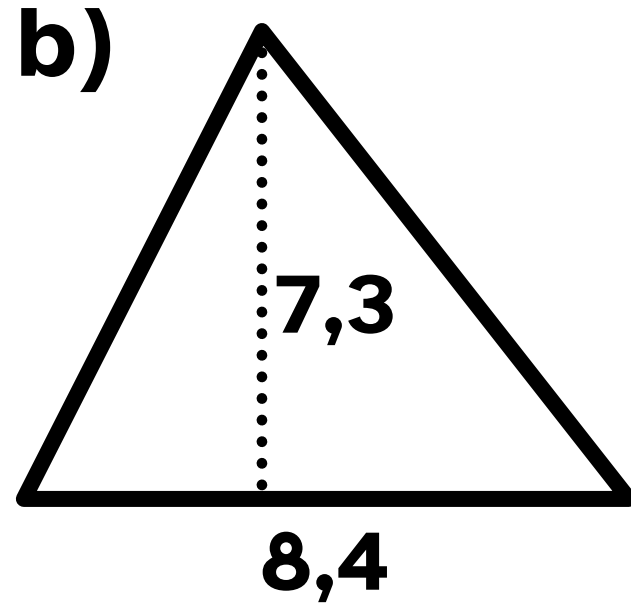
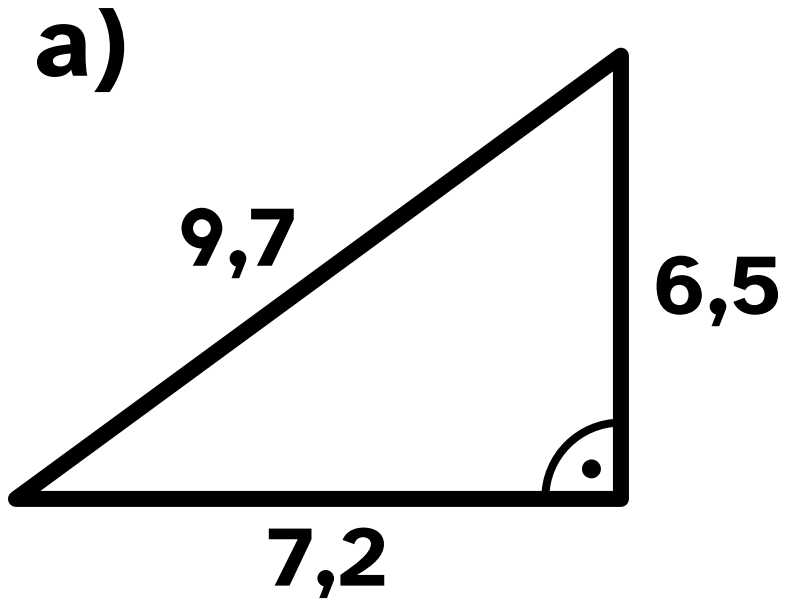
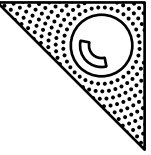

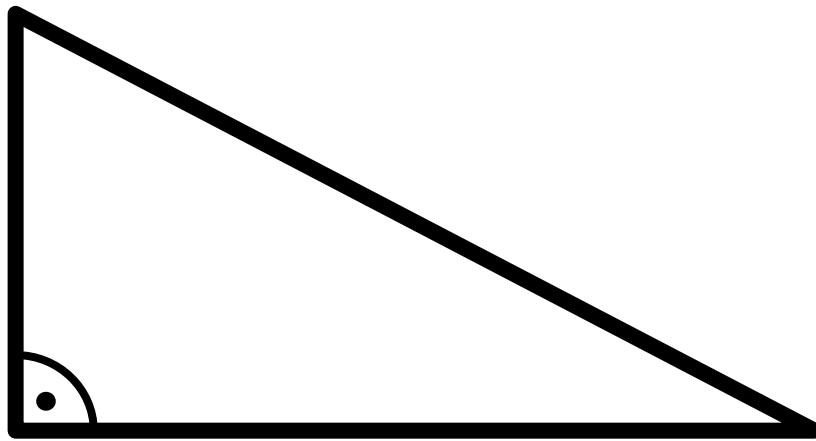
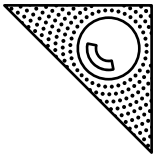

Kathete

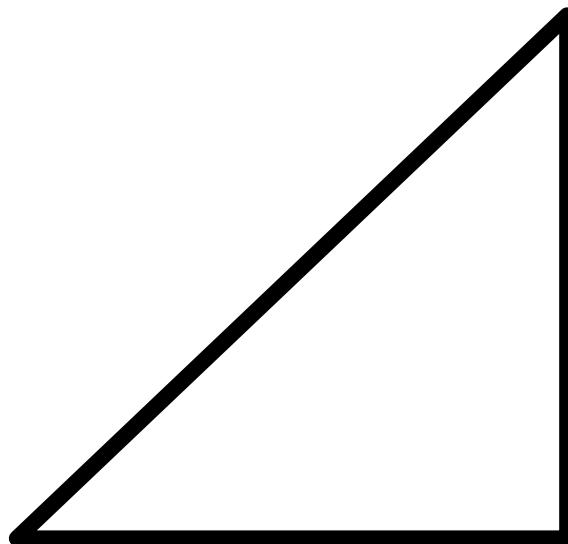
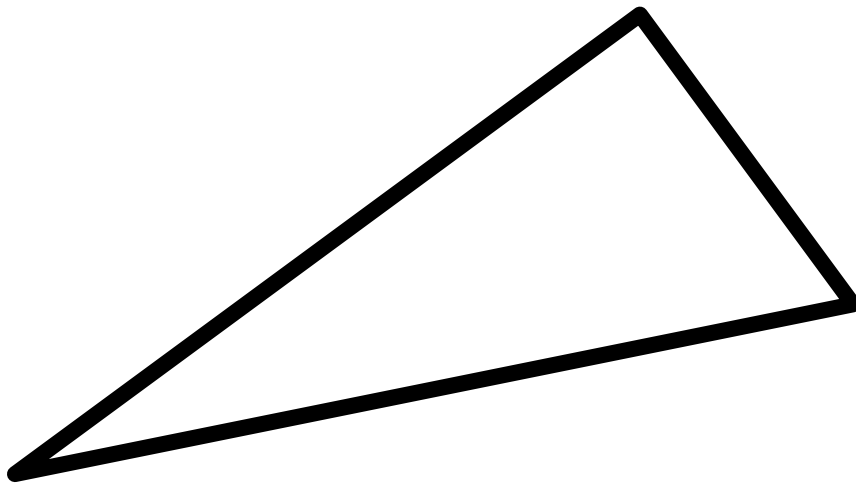

Plus3

S.132 588

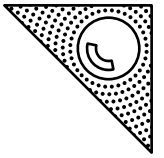

a)

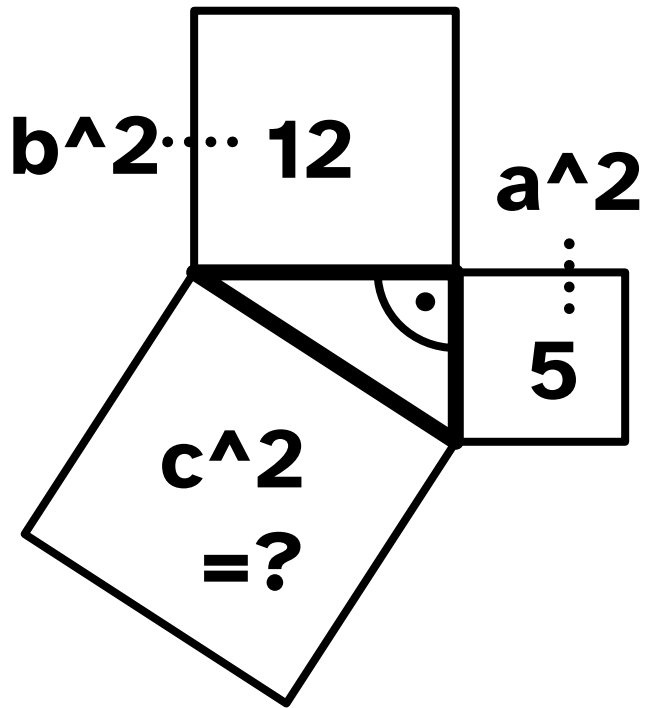

b)

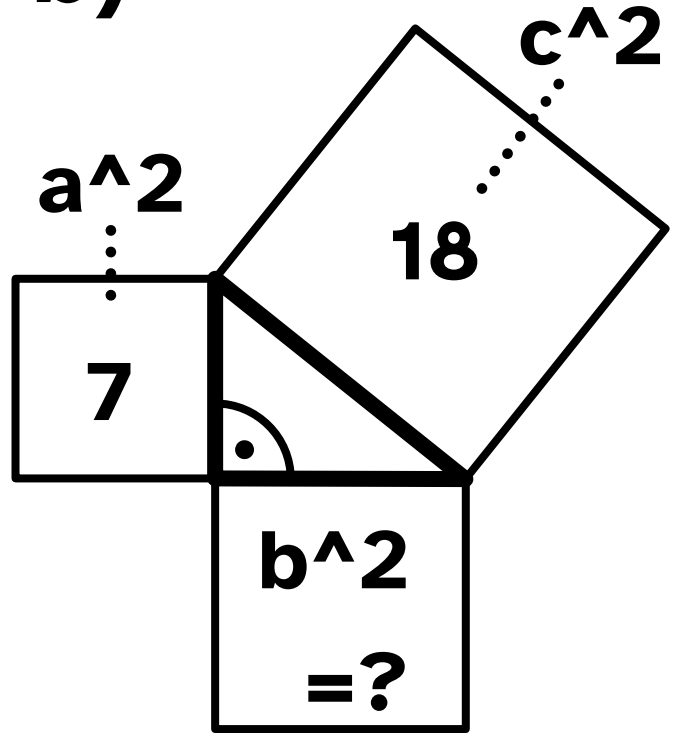

c)

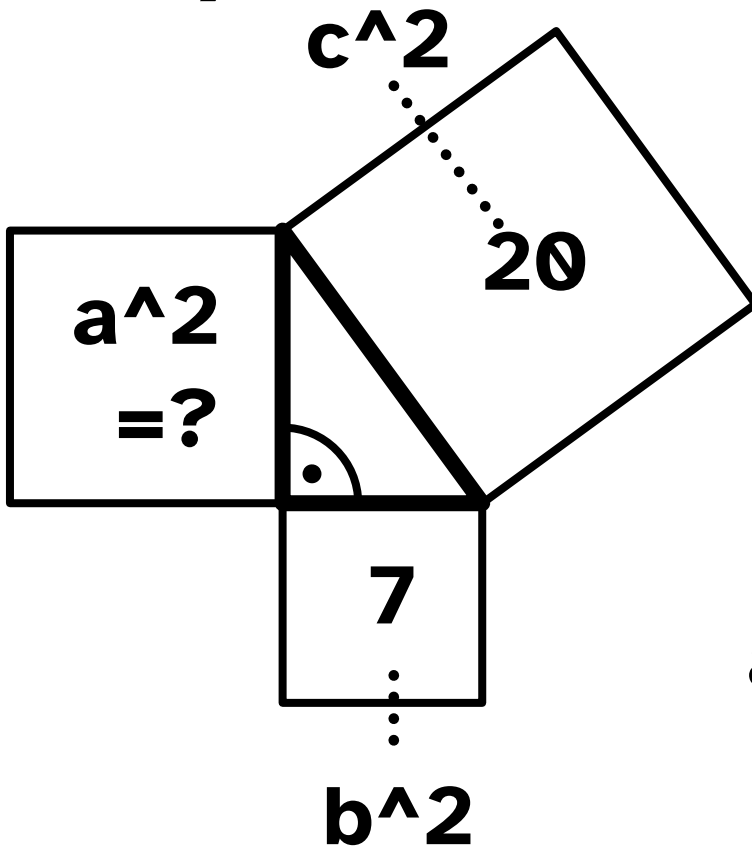

d)

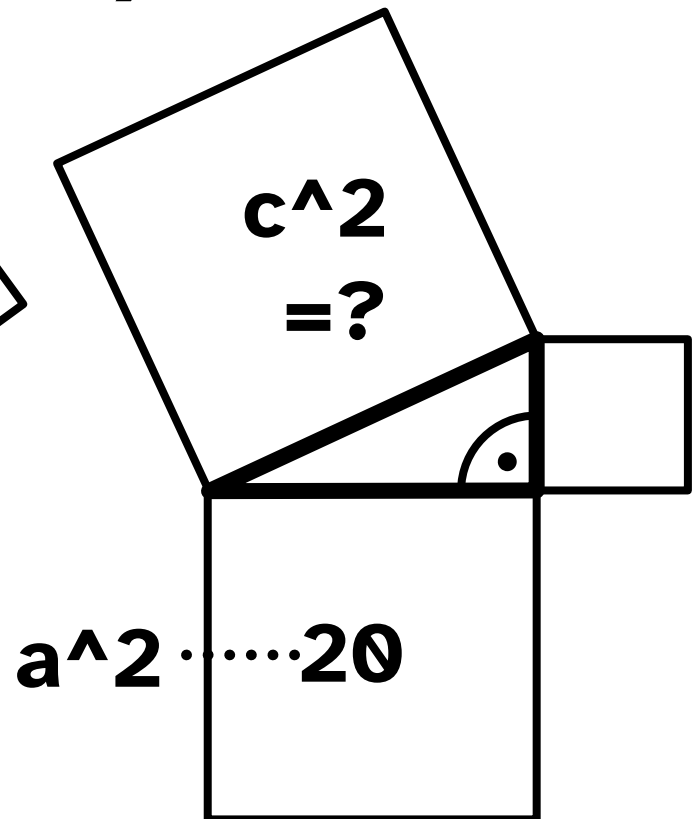

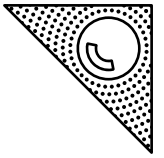

Satz des Pythagoras

$$a^2 + b^2 = c^2$$

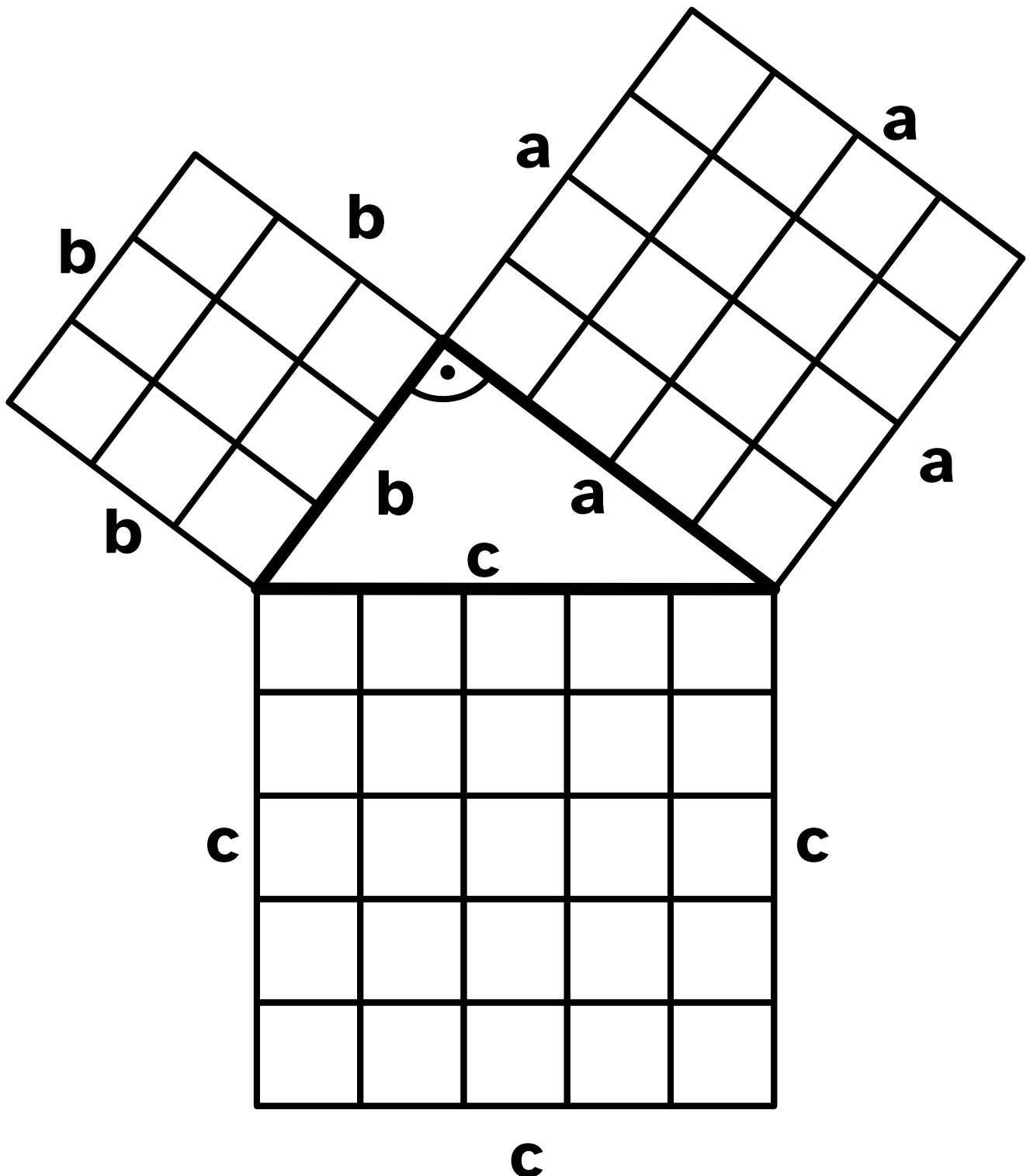

Plus3

S.134 593, 595

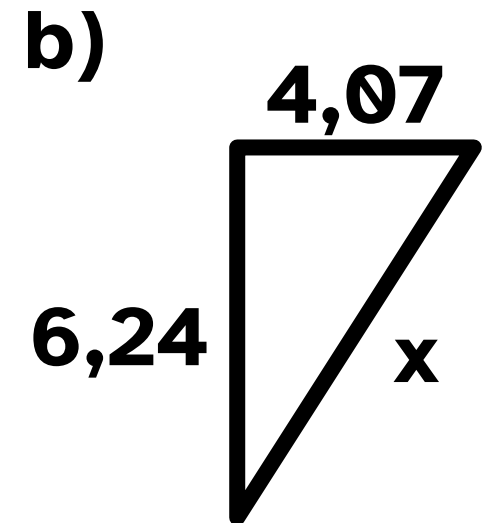
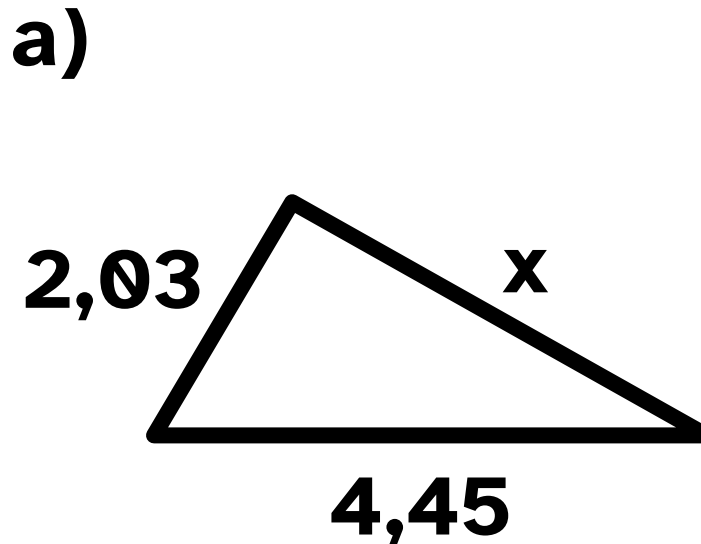
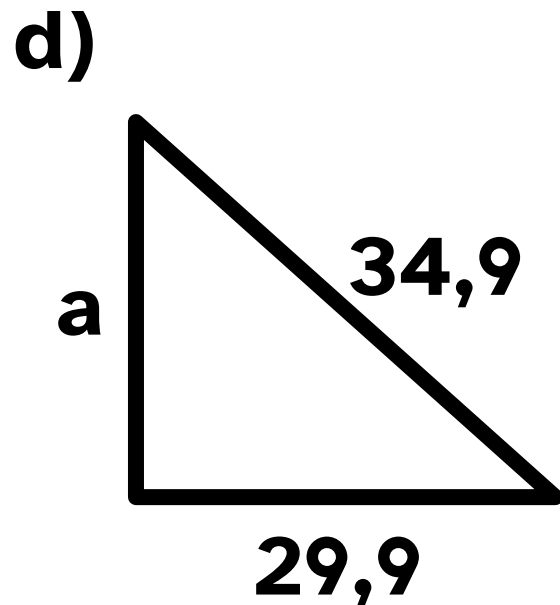
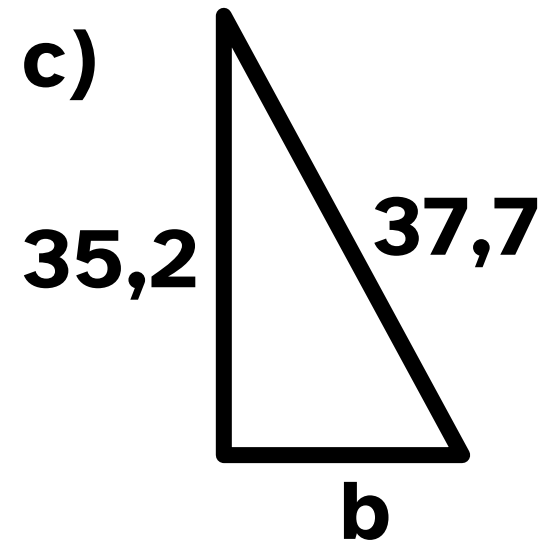
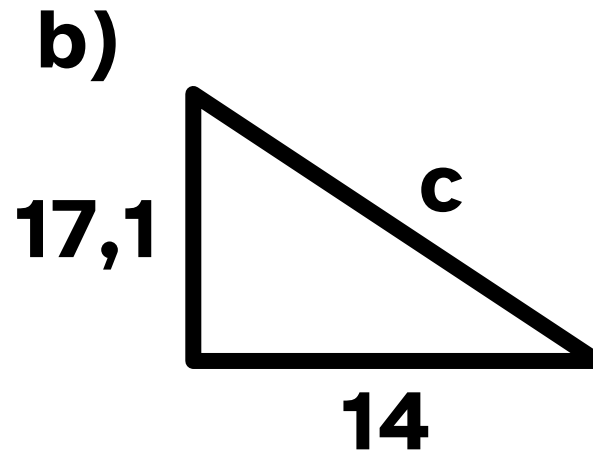
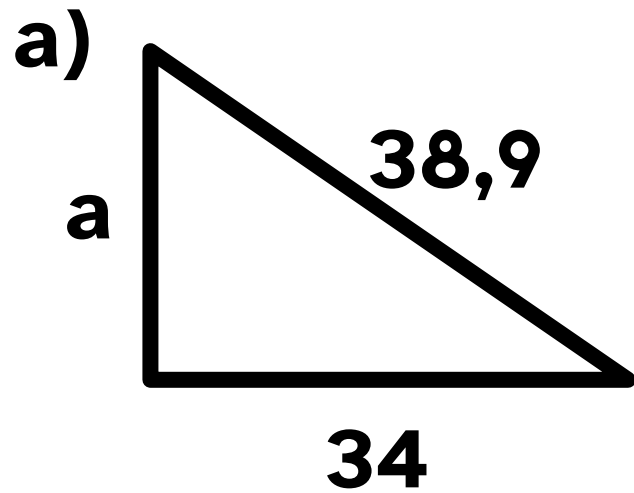
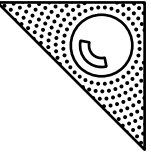

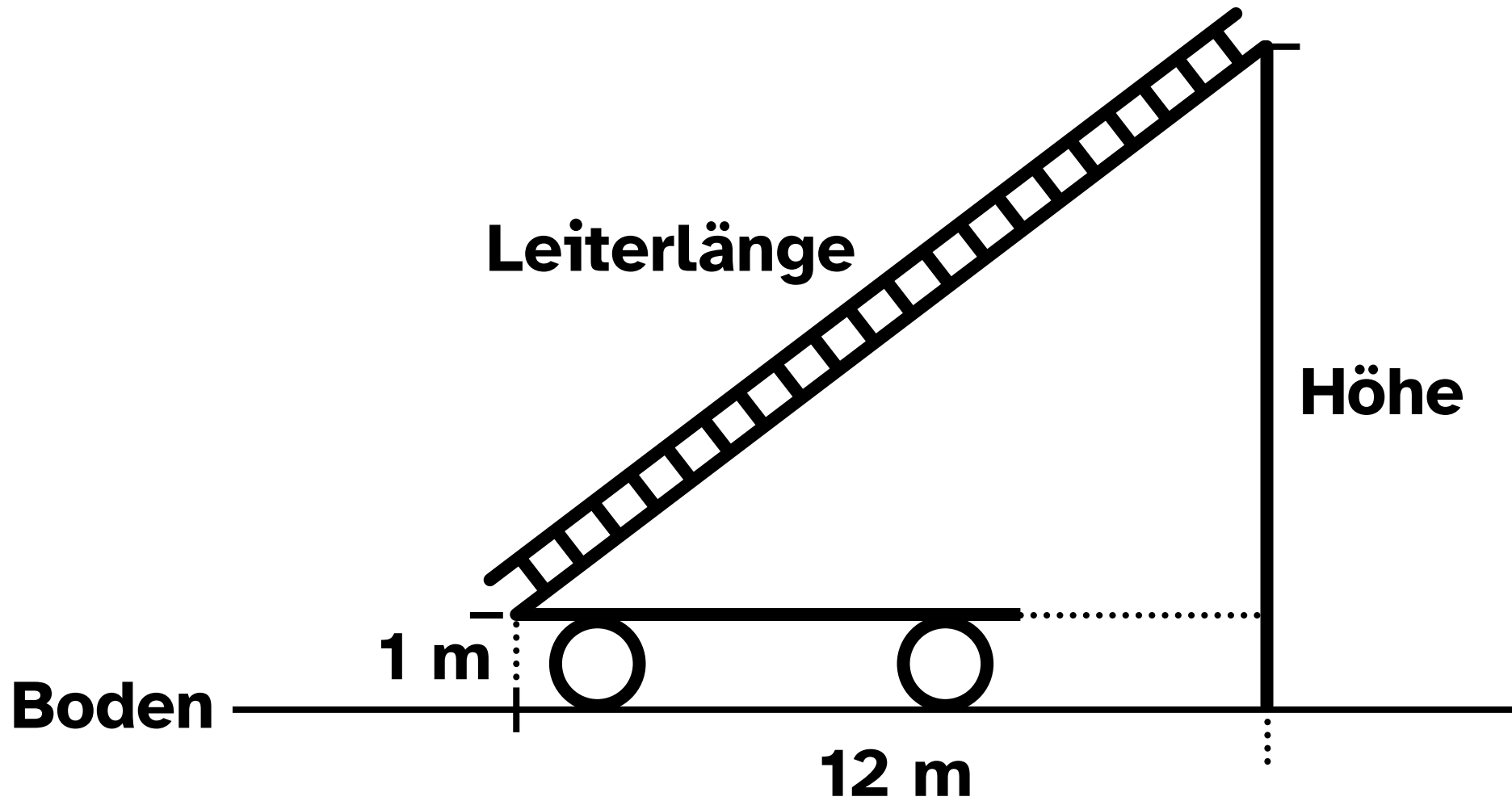
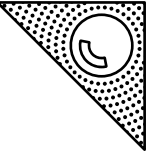

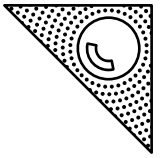

a)

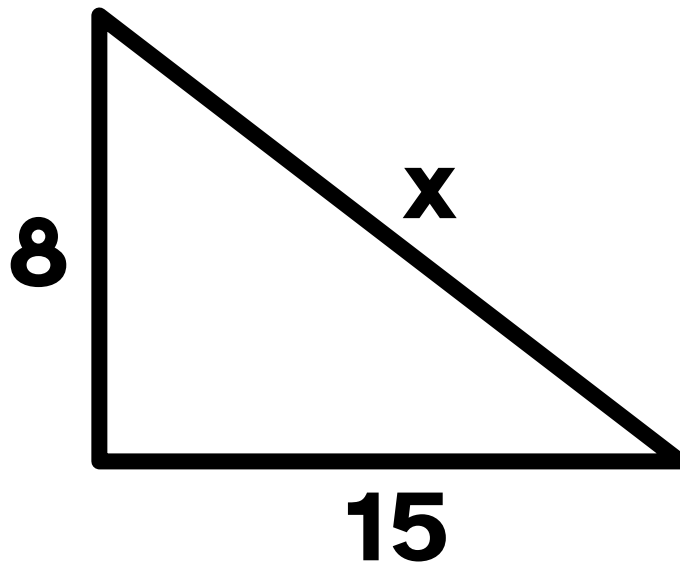

b)

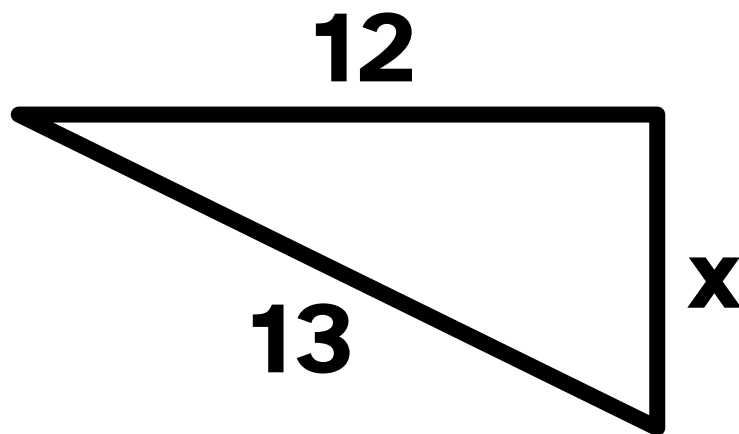

c)

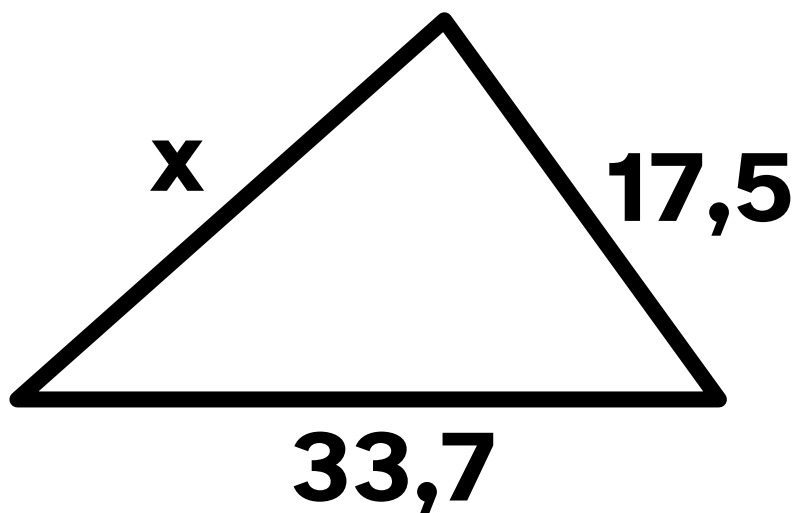

Plus3

S.14 625

